



Nicolazzi ^{1960 - 2010} **50**



Rubinetteria

Nicolazzi

S.p.A.

2014 CATALOGO LISTINO PREZZI

Catalogue price list
Catalogue tarif des prix
Katalog und Preisliste
Catálogo y lista de precios
Catálogo y lista de preços
Каталог прайс лист

www.nicolazzi.it



NICOLAZZI produce dal 1960 rubinetti,
accessori bagno e docce dallo stile esclusivo

*NICOLAZZI produces since 1960 taps,
bathroom accessories and showers with an exclusive style*

Rubinetto ecologico
fabbricato nel rispetto dell'ambiente,
un prodotto che non rilascia metalli pesanti
come piombo, nichel e zinco

*Ecologic product
manufactures respecting the enviroment
and not releasing heavy metals
(lead, nickel and zinc)*

Hand Made in Italy by *Nicolazzi*



Il vero lusso italiano
Authentic Italian Luxury

Ecologico

CONSUMO D'ACQUA RIDOTTO DEL 50%
WATER SAVING 50%

L'acqua è un bene sempre più scarso e per questo sempre più prezioso. Più di un miliardo di persone nel mondo non hanno accesso all'acqua potabile ed almeno 500 milioni soffrono di grave carenza d'acqua. Non avere accesso all'acqua significa non avere a disposizione la quantità d'acqua minima giornaliera per le funzioni vitali. Il fabbisogno minimo biologico per la sopravvivenza è infatti di 5 litri in 24 ore, ma per parlare di condizioni accettabili c'è bisogno di un minimo giornaliero di circa 50 litri d'acqua pro capite. La crescita demografica della popolazione mondiale, l'aumento del consumo d'acqua nei paesi più ricchi e l'inquinamento delle risorse idriche stanno, infatti, creando uno squilibrio tra la disponibilità e la richiesta d'acqua potabile generando una vera e propria emergenza destinata ad accentuarsi nei prossimi anni.

Nicolazzi S.p.A., a riconferma della continua attenzione rivolta alla difesa dell'ambiente ed all'ecologia, ha introdotto su tutta la rubinetteria da lavabo e da lavello uno speciale sistema di risparmio idrico al fine di ridurre del 50% il consumo d'acqua giornaliero (portata limitata a max. 5,7 L/min.). L'utilizzo di uno speciale rompigetto ad elevata aerazione garantisce inoltre la qualità del flusso di erogazione in ogni condizione di pressione.

L'acqua è un elemento fondamentale per la vita del nostro pianeta, una risorsa che deve essere protetta e preservata. Nicolazzi S.p.A. ci ha pensato, pensateci anche voi e richiedeteci i rubinetti con la riduzione di portata del 50% al fine di poter consumare anche voi solo l'acqua necessaria. Il risparmio d'acqua è un dovere civile nei confronti dei nostri simili, protegge l'ambiente (contribuisce anche alla riduzione delle emissioni di CO₂) e permette anche di risparmiare denaro.

Water is a more and more precious good because less and less available. More than a billion people in the world do not have access to drinkable water and 500 millions people have serious problems in getting water. Not having access to water means not having the minimum daily vital amount of water. Individual biological minimum need is 5 litres/24hours, but in order to have acceptable conditions we speak about 50 litres/24hours. World population increase, huge use of water in western Countries and pollution of available sources are causing a general water emergency, estimated to get worse in years to come.

Nicolazzi S.p.A., confirming once more its attention to environment, applied to all washbasins and sink mixers a "water saving system" in order to reduce by 50% the daily use of water (max 5,7 l/min). Use of a special aerator with high air amount gives a good water flow with low pressure as well.

Water is a basic element for life on our planet, a resource to be protected and saved. Nicolazzi S.p.A. cares about it, you can do the same by requiring "50% water saving" taps in order to use only the water you need. "Water saving" is a positive attitude, it protects the environment (it helps reducing carbon dioxide emissions, CO₂) and it helps you saving money.

-50%

Ecologico

PRODOTTO SENZA PIOMBO E NICHEL
CON OTTONE IN LEGA ANTIDEZINCIFICANTE
LEAD AND NICKEL FREE
BRASS ALLOY WITHOUT ZINC

Nicolazzi S.p.A., da anni attenta ai problemi derivanti dal possibile rilascio di sostanze inquinanti e tossiche dei rubinetti, si è attivata per realizzare prodotti atossici soprattutto per quanto riguarda la cessione di metalli pesanti quali PIOMBO e NICHEL. La rubinetteria Nicolazzi S.p.A. sulla base di strette normative internazionali ha applicato all'intera produzione, che interessa la rubinetteria da cucina e da lavabo, un nuovo speciale ciclo produttivo che elimina la cessione di questi metalli pesanti già all'origine. A tale proposito, Nicolazzi S.p.A. si è attivata per sostituire il trattamento chimico da anni impiegato per la rimozione del PIOMBO dai rubinetti, con l'utilizzo di ottoni SENZA PIOMBO di nuova generazione (Pb max. 0.25%) nella propria produzione ecologica. Tale scelta, pur essendo antieconomica per l'azienda, risulta essere un'ulteriore riconferma della filosofia aziendale rivolta a garantire la salute del consumatore soddisfacendo al tempo stesso la legge americana Ab1953, che ad oggi risulta essere la più restrittiva in materia. Tutto questo, abbinato all'impiego di un sistema chimico che inibisce la cessione di NICHEL a contatto con l'acqua potabile ed all'utilizzo di guarnizioni e/o prodotti non metallici atossici, ha permesso a Nicolazzi S.p.A. di testare i propri rubinetti anche secondo la norma americana NSF-61, con una cessione in acqua potabile di PIOMBO inferiore a 11 ppb (µg/l) e di NICHEL inferiore a 20 ppb (µg/l).

N.B: Le limitazioni attualmente più rappresentative per la cessione di metalli da parte di articoli di rubinetteria nelle acque potabili limitano appunto la cessione del PIOMBO a 11 ppb (µg/l) e la cessione di NICHEL a 20 ppb (µg/l).

Oltre a certificare che tutti i rubinetti per cucina e lavabo subiscono questo speciale ciclo produttivo ANTI-PIOMBO e NICHEL, i pezzi sono prodotti con ottone in lega ADZ antidezincificante (assenza rilascio di ZINCO), nel rispetto della norma Australiana Watermark e trattati secondo le norme americane NSF-61.

Nicolazzi S.p.A., prima in Italia ad adottare questo procedimento, dimostra in questo modo un'alta sensibilità ai problemi connessi all'ambiente, all'ecologia ed alla salute del consumatore.

La riconoscibilità del prodotto è garantita dal marchio "Ecologico" su ciascun rubinetto.

Nicolazzi S.p.A., very careful with issues concerning release of toxic materials from water taps, has been manufacturing for many years "health friendly" products, mainly not releasing heavy metals such as LEAD and NIKEL into drinking water.

Nicolazzi S.p.A., based on strict international rules, is using a special manufacturing system for all its sinks and washbasin taps to avoid release of heavy metals. To this regard, Nicolazzi S.p.A. has now started a re-organizing process to replace previous "LEAD washing" chemical treatment with the use of new generation LEAD-FREE brass (maximum LEAD 0.25%). This costly Company policy confirms the philosophy to grant consumers' health in respect of the new American norm Ab1953, actually the strictest one in our business. All this, with the chemical treatment to avoid release of NIKEL in drinking water and the use of non-toxic washers and components, allowed Nicolazzi S.p.A. to obtain American norm NSF-61, with a LEAD release less than 11 ppb (µg/l) and NIKEL less than 20 ppb (µg/l).

NOTE: Actually the strictest limitation for heavy metals release in drinking water for taps are LEAD less than 11 ppb (µg/l) and NIKEL less than 20 ppb (µg/l).

Beside above procedures against LEAD and NIKEL, our items are made with a special DZR brass (alloy with no release of ZINC) for the Australian Watermark regulation and produced following the NSF-61 American rules.

Nicolazzi S.p.A., the first Italian Company with this manufacturing process, shows a strong sensibility to problems regarding environment, ecology and consumers' health.

Our commitment is granted by the "ECOLOGICO" logo on each tap.

Esempi di Cessione di Nichel e Piombo da rubinetti Nicolazzi prodotti con il processo "ECOLOGICO" e rubinetti non trattati.

Examples of cession of nickel and lead from Nicolazzi's taps made with "ECOLOGICO" process, and taps not treated.

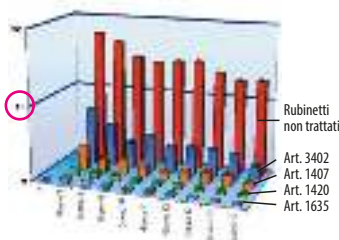

Limite massimo accettabile 11 ppb di piombo.
The acceptable maximum limit is 11 ppb of lead.

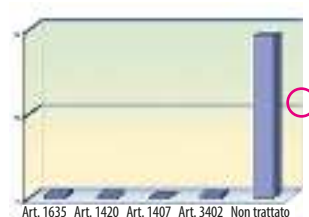

Limite massimo accettabile 20 ppb di nichel.
The acceptable maximum limit is 20 ppb of nickel.

Nicolazzi

1960 - 2010
50

La tradizione del Made in Italy di Alta Qualità nel rispetto della salute del consumatore e dell'ambiente
The tradition of High Quality Made in Italy in the environment and health respect

NEW
A RICHIESTA
ON DEMAND

Ecologico

CONSUMO D'ACQUA RIDOTTO DEL 50%
WATER SAVING 50%

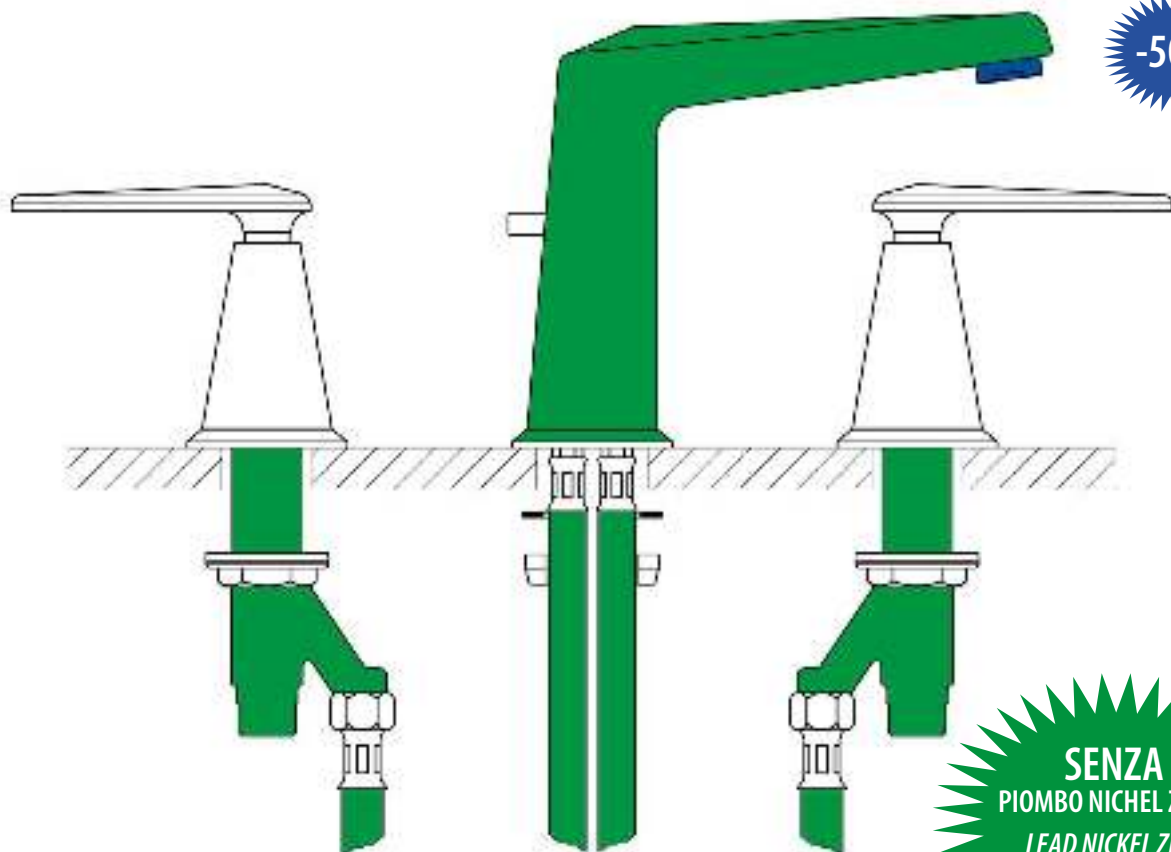

Ecologico

PRODOTTO SENZA PIOMBO E NICHEL
CON OTTONE IN LEGA ANTIDEZINCIFICANTE

LEAD AND NICKEL FREE
BRASS ALLOY WITHOUT ZINC

certificazione prodotti

products certification

USA - CANADA

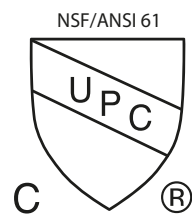

USA
LOW-LEAD

California
Lead Plumbing Law
AB 1953

USA
GREEN

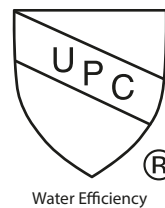

AUSTRALIA and
NEW ZEALAND



AUSTRALIA and
NEW ZEALAND



BELGIUM



BELGAQUA

RUSSIA



rubinetteria
NICOLAZZI



Dal 1960, anno della sua fondazione, la NICOLAZZI S.p.A. ha la sede in Alzo (No), piccolo paese sul lago d'Orta famoso in tutto il mondo per la lavorazione del granito prima (fino agli anni '50) e dei rubinetti oggi.

La Rubinetteria NICOLAZZI si é innestata in questa tradizione operando ad alto livello tecnologico che, insieme alla ricerca stilistica e funzionale, permette la realizzazione di una rubinetteria di qualità superiore.

La ditta NICOLAZZI studia e progetta i suoi prodotti in modo autonomo ed originale nel rispetto delle normative internazionali. Sottopone ogni pezzo ad un serio e minuzioso collaudo controllando tenuta, rumorosità, durata, funzionalità ed accurate finiture.

Questo modo di produrre ha permesso di adottare il sistema di qualità ISO 9000. La certificazione é un'ulteriore garanzia della qualità del prodotto che esce dal proprio stabilimento per raggiungere i clienti più esigenti alla ricerca di prodotti qualificati. Una efficiente rete commerciale assicura una distribuzione dei nostri prodotti sia in Italia che nel mondo.

"From 1960, the year of this establishment, the NICOLAZZI S.p.A. is placed in Alzo (No) a small village on the lake of Orta, famous all over the world for the granite-working untill the Fifties and nowadays for the production of taps.

The NICOLAZZI tap manufacturer has married this tradition working with an high technical standard, that, together with stylistic and functional research, allows the realisation of superior quality taps.

The company NICOLAZZI studies and designs its own items in an original and individual way, by respecting the International Norms. Each piece is subject to a very serious and particular inspection by testing water-seal, noise, corrosion, functionality and careful finishings.

This way of production allowed to adopt the quality system ISO 9000. The certification is a further guarantee of the quality of our items, that leave the factory to reach the most exigent clients that are looking for qualified products.

A very efficient commercial organisation assure the distribution of our articles in Italy and in the world."



certificazione
certification



SISTEMA QUALITÀ
CERTIFICATO UNI
EN ISO 9001:2008

Certificato n° 0316

tabella finiture

finishings table

- CR** CROMO / *CHROME*

- NL** NICHEL LUCIDO / *BRIGHT NICKEL*

- OG** OTTONE GREZZO / *RAW BRASS*
Ottone naturale / Natural brass

- OL** OTTONE LUCIDO / *SHINING BRASS*
Ottone naturale / Natural brass

- GO** ORO / *GOLD*

finiture speciali

special finishings

- AG** ANTIQUE GOLD / *ANTIQUE GOLD*

- BZ** BRONZATO / *BRONZE PLATED*

- CB** CROMO SPAZZOLATO / *BRUSHED CHROME*

- CO** CROMO ORO / *CHROME GOLD*

- CS** CROMO SATINATO / *SATIN CHROME*

- FV** FERRO VECCHIO / *IRON*

- GB** GOLD BRASS / *GOLD BRASS*

- GF** ORO INGLESE / *ENGLISH GOLD*

- NS** NICHEL SATINATO / *SATIN NICKEL*

- RA** RAMATO / *COPPER PLATED*

- TB** TUSCAN BRASS / *TUSCAN BRASS*
Ottone naturale / Natural brass

- CL** COLORATO / *COLOURED*

Nota/Note

Nelle "finiture speciali" e OG-OL le doccette ed i ganci duplex in ABS verranno sostituite con un modello in ottone (C7104M-C7111-C7135-C7125-C7136)

In the "special finishing" and OG-OL the hand showers and the duplex hook in ABS will be replaced with one in brass (C7104M-C7111-C7135-C7125-C7136)



CR

Classica finitura galvanica di cromo lucido realizzata a spessore al fine di garantire lunga durata. L'elevata durezza superficiale tipica del cromo conferisce ai prodotti elevate doti di resistenza.

Standard chrome finishing worked in «thick layer» to give long durability and strong resistance.



FV

Finitura galvanica di tonalità scura, sottoposta a lavorazione manuale di "spazzolatura" e protetta da vernice trasparente opaca.

Dark galvanic finishing, hand brushed and protected with a matt transparent paint. Good for modern and antique styles.



GF

Finitura galvanica di doratura realizzata a spessore con i medesimi materiali impiegati per il gold brass però con concentrazione ridotta al fine di fornire un oro di tonalità ancora più chiara tipica dei paesi anglosassoni.

Galvanic gold colour. Second shade of gold colour.



AG

Finitura galvanica con tonalità simile all'oro antico, sottoposta a lavorazione manuale di "spazzolatura" e protetta da vernice trasparente opaca. Indicata per le serie classiche.

Galvanic gold colour, hand brushed and protected with a matt transparent paint. Indicated for classic style.



TB

Finitura di esclusiva Nicolazzi che conferisce un vero look antico ai prodotti tramite ossidazione dell'ottone. **IMPORTANTE:** questa è una finitura "viva" (non protetta) che cambia nel tempo offrendo variazioni di colore tipiche dell'ossidazione dell'ottone in abbinamento al tipico colore giallo del metallo che riemerge nelle zone di maggior contatto durante l'uso (maniglie, canne, etc.). **NON PULIRE CON PRODOTTI AGGRESSIVI.**

Exclusive finishing from Nicolazzi. Real antique look. Galvanic oxidation of brass. IMPORTANT to know it is a «Living Finishing», it changes in time. A brass colour will come out. DO NOT CLEAN WITH AGGRESSIVE PRODUCTS.

Ottone naturale soggetto ad ossidazione
Living natural brass

ISTRUZIONI PER LA PULIZIA

CLEANING INSTRUCTIONS

La pulizia di tutti i nostri prodotti deve essere eseguita esclusivamente utilizzando acqua, sapone neutro ed un panno morbido (NON abrasivo) al fine di preservarne la finitura nel tempo. Tutti i prodotti devono sempre essere asciugati con un panno morbido (NON abrasivo) al fine di impedire la formazione di depositi di calcare. Per quanto riguarda la finitura TB suggeriamo l'utilizzo della nostra speciale cera (articolo C9996) al fine di mantenere nel tempo il tipico colore "marrone". Le finiture non sono coperte da garanzia in quanto subordinate alla cura dell'utente.

Concerning cleaning of our products we suggest you to use always water, neutral soap and a soft cloth. This will allow you to preserve finishings for a long time. For TB we have a special wax (item C9996) to maintain longer its typical «brown» colour. Finishings are not covered by warranty.



Finitura con le medesime caratteristiche del cromo con l'aggiunta della lavorazione manuale di "spazzolatura". Ottima sia per le serie moderne che per le serie classiche.

Like CR but hand brushed. Good for modern and antique styles.

CB



Finitura con medesime caratteristiche del cromo realizzata su superficie satinata anziché lucida. Normalmente viene utilizzata nelle serie moderne ed è eccellente, vista la sua resistenza, per la linea cucina.

Chrome finishing on a «rough» surface. Normally used on modern styles and excellent for kitchen faucets for its strength.

CS



Tipica finitura galvanica di nichel lucido. Eccellente per le serie classiche. **IMPORTANTE:** Nicolazzi offre questa finitura allo stesso prezzo del cromo. Rivestimento di base per la finitura oro, pur essendo realizzata a spessore, mantiene le caratteristiche tipiche del metallo nichel (morbidezza e predisposizione a lievi variazioni di tono nel tempo).

Typical galvanic polished nickel finishing. Excellent for antique style. IMPORTANT is Nicolazzi offers it at same price than Chrome. First shade of gold colour.

NL



Finitura con le medesime caratteristiche del Nichel con l'aggiunta della lavorazione manuale di "spazzolatura". Normalmente chiamata "color acciaio" è eccellente sia per le serie moderne che per le serie classiche.

Just like Nickel but hand brushed. Normally called «STEEL colour». Excellent for modern and classic styles.

NS



Finitura galvanica di doratura realizzata a spessore con i medesimi materiali impiegati per l'oro però con concentrazione ridotta al fine di fornire un oro di tonalità più chiara.

Galvanic gold colour. Third shade of gold colour.

GB



Rivestimento di vero oro 24k a spessore, ottenuto tramite processo galvanico che utilizza il sale industriale KAu(CN)₂ estratto direttamente dal metallo prezioso.

Real 24k gold, obtained with the use in galvanic basin of an industrial salt KAu(CN)₂ extracted from Genuine Gold Metal. Darkest shade of gold colour.

GO



Tipica finitura galvanica di bronzatura, sottoposta a lavorazione manuale di "spazzolatura" e protetta da vernice trasparente lucida.

Typical Bronze galvanic finishing, hand brushed and covered with a brilliant transparent paint.

BZ



Tipica finitura rame eseguita galvanicamente, sottoposta a lavorazione manuale di "spazzolatura" e protetta da vernice trasparente lucida.

Typical Copper galvanic finishing, hand brushed and covered with a brilliant transparent paint.

RA



Finitura di esclusiva Nicolazzi che conferisce un vero look antico ai prodotti. **IMPORTANTE:** questa è una finitura "viva" (non protetta) in quanto trattasi di ottone grezzo naturale non protetto che cambia nel tempo offrendo tonalità scure tipiche della passivazione del metallo.

Exclusive finishing from Nicolazzi. Real antique look. IMPORTANT to know it is a «Living Finishing» that changes in time. It is raw not protected brass, it will soon be darker.

OG

Ottone naturale soggetto ad ossidazione
Living natural brass



Finitura tipica dell'ottone sottoposto a lavorazione di lucidatura brillante. **IMPORTANTE:** questa è una finitura "viva" (non protetta) in quanto trattasi di ottone lucido naturale non protetto che cambia nel tempo offrendo tonalità scure tipiche della passivazione del metallo.

Polished brass NOT protected. IMPORTANT to know it is a «Living Finishing» that changes in time. It is not protected brass, it will soon be darker.

OL

Ottone naturale soggetto ad ossidazione
Living natural brass

Finitura colorata ottenuta tramite verniciatura in polvere cotta successivamente in forno al fine di conferire elevate doti di resistenza; disponibile in BIANCO e NERO sia nella versione "lucida" che "opaca".
CL Colour finishing available in WHITE and BLACK in both «matte or shining» versions.

CL

guida alla composizione del codice di acquisto instructions to compose the purchase code

La composizione del codice d'acquisto deve essere eseguita nel seguente modo:
The composition of the purchase code must be effected in the following way:

esempio / for example

Art. **2002 CR 38**

Tipo di maniglia / Type of handle

Sigla finitura / Finishing abbreviaton

Codice articolo / Code article

I cristalli utilizzati nella produzione Nicolazzi fanno parte della Collezione SWAROVSKI ELEMENTS

Crystals in Nicolazzi products are part of SWAROVSKI ELEMENTS Collection

Il marchio SWAROVSKI ELEMENTS è assicurazione di qualità originale. Ogni componente SWAROVSKI ELEMENTS reca il marchio permanente SWAROVSKI®.

The SWAROVSKI ELEMENTS signature is the assurance of original quality. Every SWAROVSKI ELEMENTS component carries the permanent SWAROVSKI® signature.

Solo SWAROVSKI ELEMENTS assicura la massima brillantezza e un gioco di colori senza confronti, grazie alla purezza dei materiali utilizzati e all'eccellenza della lavorazione e del taglio SWAROVSKI®.

Only SWAROVSKI ELEMENTS offers the highest brilliance and unique color play, thanks to the purity of the raw materials and the excellence of the SWAROVSKI® cutting and polishing technology.

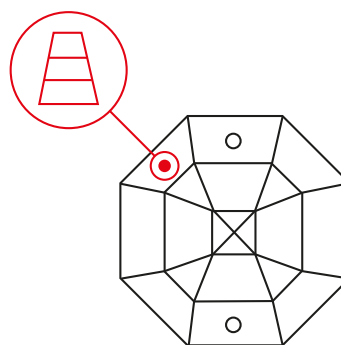

SWAROVSKI® è un marchio registrato
SWAROVSKI® is a trademark

Le pietre utilizzate nella produzione Nicolazzi fanno parte della Collezione NICOLAZZI NATURAL STONES

Stones in Nicolazzi products are part of NICOLAZZI NATURAL STONES Collection



Il marchio NICOLAZZI NATURAL STONES assicura la qualità e la lavorazione artigianale delle pietre.
The NICOLAZZI NATURAL STONES signature is the assurance of stones quality and hand made cutting.



Il colore delle pietre si intende a titolo indicativo. Eventuali inclusioni e sfumature di colore fra gemme uguali sono a conferma della purezza e della naturalità delle stesse.
Colors of stones are to be considered as indicative. Any vein and colour change means purity and natural origin of stones.

Nicolazzi

index
index

EXTRA LUSO

IMPERO	Pag. 15
CRISTALLO DI ROCCA	Pag. 21
ONICE	Pag. 27
LE PIETRE	Pag. 33
TEIDE CHIC	Pag. 41
TEIDE FOUR	Pag. 47
MARGHERITA - VINCENT	Pag. 53
VINCENT monocomando	Pag. 59
TEIDE - TEIDE DECORATED CERAMICS	Pag. 63
TEIDE FULL DECORATED CERAMICS	Pag. 72
TEIDE GRANITO	Pag. 74
CRISTALLO	Pag. 77
MONTEROSA	Pag. 81
HALF DOME CRYSTAL - LIBERTY - LIBERTY BLACK	Pag. 89

NEW

NEW

NEW

NEW

TRADIZIONALE

DAMES ANGLAISES - HALF DOME - EL CAPITAN	
PETIT MONT BLANC - FOREST - TOSA - CERAMICA NERA	Pag. 95
MONTE CROCE - MAC KINLEY 05	Pag. 111
NUOVA BRENTA - MONT BLANC - MAC KINLEY	Pag. 119

MONOCOMANDI

CINQUANTA	Pag. 129
EL CAPITAN - PETIT MONT BLANC - FOREST - CRISTALLO	
DECORATED CERAMICS - LIBERTY BLACK - CERAMICA NERA	Pag. 137
ANTELAO	Pag. 141
OLYMPUS	Pag. 145
JUNGFRAU	Pag. 153
DIAMIR 2	Pag. 157
SIGNAL	Pag. 163
DOM	Pag. 167

TERMOSTATICO

Pag. 171

PROGRAMMA CUCINA

Pag. 185

ACCESSORI BAGNO

EXTRA LUSO Impero/Cristallo di rocca/Onice	
Teide chic/Vincent - Margherita	Pag. 210
MINIMALE	Pag. 223
CLASSICI cristalli/pietre/ceramiche decorate/antichi	
ceramiche nere/cristalli neri	Pag. 227
TEIDE antichi/ceramiche decorate	Pag. 235
ACCESSORI D'APPOGGIO neri/decorati/antichi	Pag. 237
GRAB BAR	Pag. 241

DOCCIA COLLECTION

Pag. 243

SCARICHI pop-up waste

Pag. 257

ARTICOLI VARI various articles

Pag. 257

MANIGLIE E LEVE handles and levers

Pag. 257

Le illustrazioni di questa pubblicazione si intendono a titolo indicativo. NICOLAZZI S.p.A. si riserva pertanto il diritto di applicare ai propri prodotti, in qualsiasi momento e senza preavviso, quelle modifiche che ritenesse utili per migliorarli.

The illustrations of this catalogue are to be considered as indicative. NICOLAZZI S.p.A. reserve the right to produce, in any time without previous notice, the necessary modifications in order to improve the quality of their items.

Les illustrations de ce catalogue s'intendent à titre indicatif. NICOLAZZI S.p.A. se réserve le droit d'apporter à ses articles, à n'importe quel moment et sans préavis, toutes les modifications nécessaires pour les améliorer.

Die Abbildungen dieses Kataloges sollen als indacativ betrachtet werden. Nicolazzi S.p.A. reserviert das Recht, innen jederzeit ohne benachrichtigen die notwendigen Änderungen zu produzieren, zwecks die Qualität ihrer Einzelteile verbessern.

serie extra lusso

■ IMPERO



NEW

■ CRISTALLO DI ROCCA



NEW

■ ONICE



NEW

■ LE PIETRE



■ TEIDE CHIC



NEW

■ TEIDE FOUR



■ MARGHERITA
■ VINCENT



■ VINCENT



■ TEIDE
■ TEIDE FULL DECORATED
CERAMICS
■ TEIDE GRANITO



■ CRISTALLO



■ MONTEROSA



■ HALF DOME CRYSTAL
■ LIBERTY
■ LIBERTY BLACK



Nicolazzi

■ IMPERO

NEW



Ecologico
PRODOTTO SENZA PIOMBO E NICHEL
CON OTTONE IN LEGA ANTIDIZINCIFICANTE
LEAD AND NICKEL FREE
BRASS ALLOY WITHOUT ZINC

Nicolazzi



IMPERO





IMPERO



Impero

Per la serie Impero sono disponibili anche:
For the Impero serie is also available:

Accessori Bagno
Bathroom Accessories
(vedi pag. 338)



Termostatici
Thermostatic
(vedi pag. 279)



Programma Doccia
Shower Program
(vedi pag. 423)



****36 Impero**



****36L Impero**

■ CRISTALLO DI ROCCA



Ecologico
PRODOTTO SENZA PIOMBO E NICHEL
CON OTTONE IN LEGA ANTIDIZINCIFICANTE
LEAD AND NICKEL FREE
BRASS ALLOY WITHOUT ZINC



Nicolazzi

NATURAL
STONES



NATURAL
STONES



CRISTALLO DI ROCCA

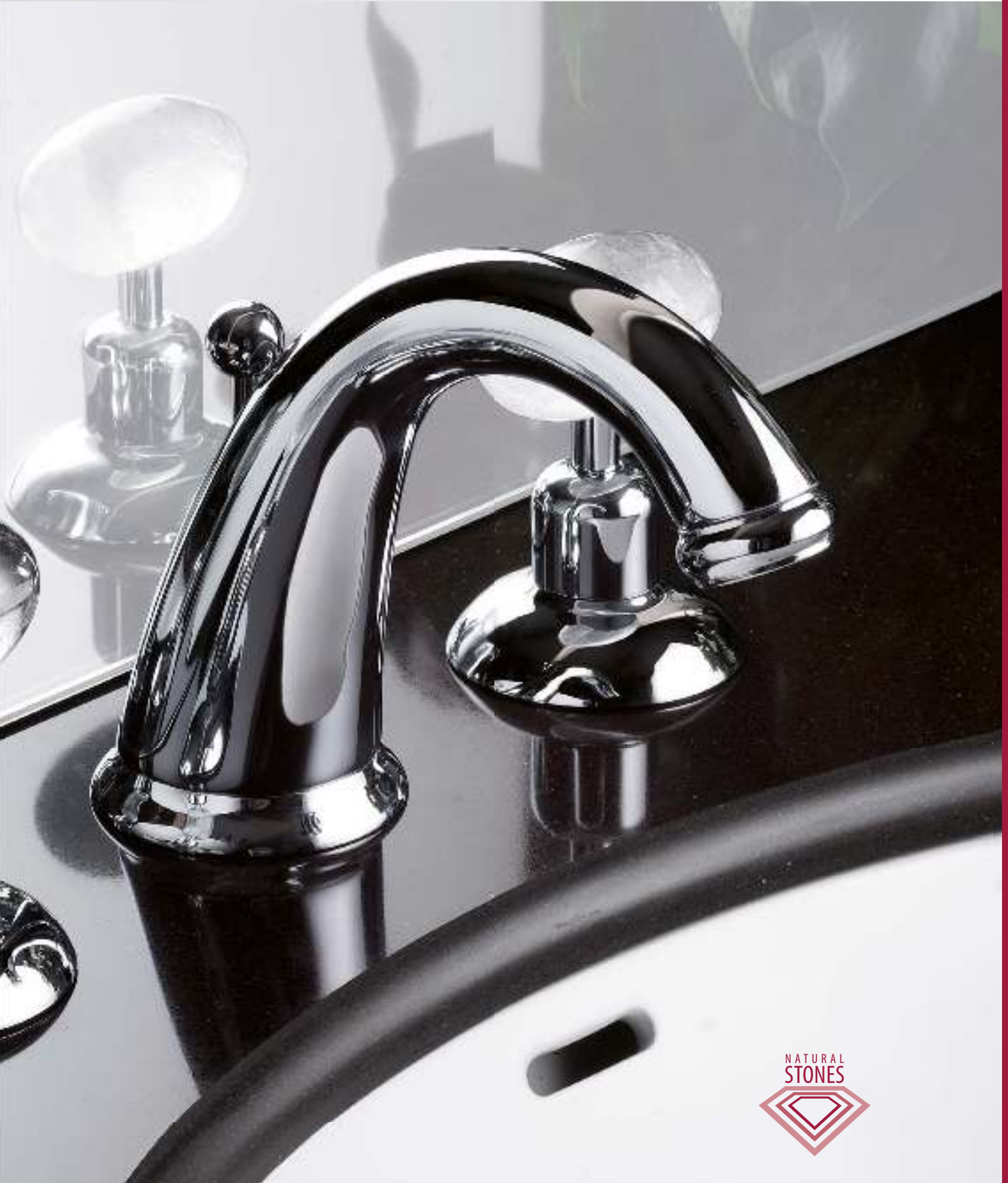



CRISTALLO DI ROCCA



Cristallo di Rocca

Per la serie Cristallo di Rocca sono disponibili anche:
For the Cristallo di Rocca serie is also available:

Accessori Bagno
Bathroom Accessories
(vedi pag. 347)



Termostatici
Thermostatic
(vedi pag. 279)



Programma Doccia
Shower Program
(vedi pag. 423)



Cristallo di Rocca
Cristallo di Rocca



Rosa Candoglia
Candoglia Pink



Malachite
Malachite



Lapislazuli
Lapis Lazuli



Zoisite
Zoisite



Granito Alzo
Alzo Granite

Il colore delle pietre si intende a titolo indicativo. Eventuali inclusioni e sfumature di colore fra gemme uguali sono a conferma della purezza e della naturalità delle stesse.

Colors of stones are to be considered as indicative. Any vein and colour change means purity and natural origin of stones.

Les couleurs des pierres s'entendent à titre indicatif. Des inclusions et légères différences de couleur parmi les mêmes confirment la pureté et le caractère naturel des pierres.

■ ONICE

NEW



Ecologico
PRODOTTO SENZA PIOMBO E NICHEL
CON OTTONE IN LEGA ANTIDIZINCIFICANTE
LEAD AND NICKEL FREE
BRASS ALLOY WITHOUT ZINC



Nicolazzi



ONICE





ONICE



Onice

Per la serie Onice sono disponibili anche:
For the Onice serie is also available:

Accessori Bagno
Bathroom Accessories
(vedi pag. 355)



Termostatici
Thermostatic
(vedi pag. 279)



Programma Doccia
Shower Program
(vedi pag. 423)



Il colore delle pietre si intende a titolo indicativo. Eventuali inclusioni e sfumature di colore fra gemme uguali sono a conferma della purezza e della naturalità delle stesse.

Colors of stones are to be considered as indicative. Any vein and colour change means purity and natural origin of stones.

Les couleurs des pierres s'intendent à titre indicatif. Des inclusions et légères différences de couleur parmi les mêmes confirment la pureté et le caractère naturel des pierres.

LE PIETRE





LE PIETRE





LE PIETRE





LE PIETRE



Le Pietre



2101 Gruppo vasca esterno con doccia
Bathtub set with shower



2103 Gruppo vasca incasso erogazione a parete
Bathtub set, wall mtg. central "sail" spout



2104 Gruppo bordo vasca 4 fori
Bathtub mixer on edge type with 4 holes



2108 Batteria lavabo scarico automatico
Wash basin mixer with automatic pop-up waste



2132 Monoforo lavabo scarico automatico
Basin single-hole mixer automatic pop-up waste

Per la serie Le Pietre sono disponibili anche:
For the Le Pietre serie is also available:

Accessori Bagno
Bathroom Accessories
(vedi pag. 387)

Termostatici
Thermostatic
(vedi pag. 279)

Programma Doccia
Shower Program
(vedi pag. 423)



Il colore delle pietre si intende a titolo indicativo. Eventuali inclusioni e sfumature di colore fra gemme uguali sono a conferma della purezza e della naturalità delle stesse.

Colors of stones are to be considered as indicative. Any vein and colour change means purity and natural origin of stones.

Les couleurs des pierres s'entendent à titre indicatif. Des inclusions et légères différences de couleur parmi les mêmes confirment la pureté et le caractère naturel des pierres.



Rubino Tagliato
Cut Rubin



Ametista
Amethyst



Quarzo Rosa
Pink Quartz



Quarzo Citrino
Citrine Quartz



Diaspro Egiziano
Egyptian Diaspore



Agata Verde
Green Agate



Quarzo Aventurina
Aventurine Quartz

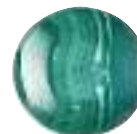

Malachite
Malachite



Lapislazuli
Lapis Lazuli



Occhio di Tigre
Tiger's Eye



Giada Imperiale
Imperial Jade



Rubino
Rubin



Madreperla
Mother of pearl



Zoisite
Zoisite



Granito Alzo
Alzo Granite

■ TEIDE CHIC

NEW



Ecologico
PRODOTTO SENZA PIOMBO E NICHEL
CON OTTONE IN LEGA ANTIDIZINCIFICANTE
LEAD AND NICKEL FREE
BRASS ALLOY WITHOUT ZINC



Nicolazzi



TEIDE CHIC



NATURAL
STONES



NATURAL
STONES



TEIDE CHIC



Teide Chic

Per la serie Teide Chic sono disponibili anche:
For the Teide Chic serie is also available:

Accessori Bagno
Bathroom Accessories
(vedi pag. 363)



Termostatici
Thermostatic
(vedi pag. 279)



Programma Doccia
Shower Program
(vedi pag. 423)



****06C Teide Chic Decorated**



****15C Teide Chic**



Rosa Candoglia
Candoglia Pink



Malachite
Malachite



Lapislazuli
Lapis Lazuli



Zoisite
Zoisite



Occhio di Tigre
Tiger's Eye

Il colore delle pietre si intende a titolo indicativo. Eventuali inclusioni e sfumature di colore fra gemme uguali sono a conferma della purezza e della naturalità delle stesse.

Colors of stones are to be considered as indicative. Any vein and colour change means purity and natural origin of stones.

Les couleurs des pierres s'intendent à titre indicatif. Des inclusions et légères différences de couleur parmi les mêmes confirment la pureté et le caractère naturel des pierres.

■ TEIDE FOUR



Ecologico
PRODOTTO SENZA PIOMBO E NICHEL
CON OTTONE IN LEGA ANTIDIZINCIFICANTE
LEAD AND NICKEL FREE
BRASS ALLOY WITHOUT ZINC

Nicolazzi



TEIDE FOUR





TEIDE FOUR



Teide Four

Per la serie Teide Four sono disponibili anche:
For the Teide Four serie is also available:

Accessori Bagno
Bathroom Accessories
(vedi pag. 405)



Termostatici
Thermostatic
(vedi pag. 279)



Programma Doccia
Shower Program
(vedi pag. 423)



■ MARGHERITA

■ VINCENT





MARGHERITA-VINCENT



Margherita - Vincent



1004 Gruppo bordo vasca 4 fori
Bath tub mixer on edge type
with 4 holes

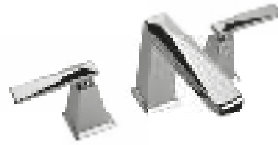

1008 Batteria lavabo scarico
automatico
Wash basin mixer with
automatic pop-up waste

Per la serie Margherita - Vincent sono disponibili anche:
For the Margherita - Vincent serie is also available:

Accessori Bagno
Bathroom Accessories
(vedi pag. 371)



Termostatici
Thermostatic
(vedi pag. 279)



Programma Doccia
Shower Program
(vedi pag. 423)



****28 Vincent**



****38 Margherita**



monocomando

■ VINCENT





monocomando VINCENT



monocomando Vincent



3001 *Monocomando vasca esterno con doccia*
Single-lever bath mixer with shower



3002 *Monocomando per lavabo con scarico automatico*
Single-lever wash basin mixer



3003 *Monocomando per bidet con scarico automatico*
Single-lever bidet mixer



3006 *Monocomando doccia incasso*
Single-lever for built-in shower

Per la serie Vincent sono disponibili anche:
For the Vincent serie is also available:

Accessori Bagno
Bathroom Accessories
(vedi pag. 371)



Termostatici
Thermostatic
(vedi pag. 279)



Programma Doccia
Shower Program
(vedi pag. 423)



■ TEIDE



Ecologico
PRODOTTO SENZA PIOMBO E NICHEL
CON OTTONE IN LEGA ANTIDIZINCIFICANTE
LEAD AND NICKEL FREE
BRASS ALLOY WITHOUT ZINC

Nicolazzi



TEIDE





MADE WITH
SWAROVSKI
ELEMENTS

TEIDE





MADE WITH
SWAROVSKI
ELEMENTS

TEIDE



MADE WITH
SWAROVSKI
ELEMENTS

Teide



1901 Gruppo vasca esterno con doccia
Bathtub set with shower



1902 Gruppo vasca esterno con doccia duplex
Bathtub set with duplex shower



1903 Gruppo vasca incasso erogazione a parete
Bathtub set, wall mtg. central "sail" spout



1904 Gruppo bordo vasca 4 fori
Bathtub mixer on edge type with 4 holes



1908 Batteria lavabo scarico automatico
Wash basin mixer with automatic pop-up waste



1915 Batteria per bidet esterna
Outer group for bidet



****39W** White ceramics



****39** Decorated ceramics



****05** Metal



****17** Crystal lever

MADE WITH
SWAROVSKI
ELEMENTS



****15** Crystal handle

MADE WITH
SWAROVSKI
ELEMENTS

Teide Full



1901 Gruppo vasca esterno con doccia
Bathtub set with shower



1902 Gruppo vasca esterno con doccia duplex
Bathtub set with duplex shower



1903 Gruppo vasca incasso erogazione a parete
Bathtub set, wall mtg. central "sail" spout



1904 Gruppo bordo vasca 4 fori
Bathtub mixer on edge type with 4 holes



1908 Batteria lavabo scarico automatico
Wash basin mixer with automatic pop-up waste



1915 Batteria per bidet esterna
Outer group for bidet



****06D** Full decorated ceramics



****06W** Full white ceramics

■ TEIDE FULL DECORATED CERAMICS



Teide Granito



1901 Gruppo vasca esterno con doccia
Bathtub set with shower



1902 Gruppo vasca esterno con doccia duplex
Bathtub set with duplex shower



1903 Gruppo vasca incasso erogazione a parete
Bathtub set, wall mtg. central "sail" spout



1904 Gruppo bordo vasca 4 fori
Bathtub mixer on edge type with 4 holes



1908 Batteria lavabo scarico automatico
Wash basin mixer with automatic pop-up waste

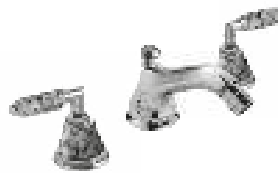

1915 Batteria per bidet esterna
Outer group for bidet



Il colore delle pietre si intende a titolo indicativo. Eventuali inclusioni e sfumature di colore fra gemme uguali sono a conferma della purezza e della naturalità delle stesse.

Colors of stones are to be considered as indicative. Any vein and colour change means purity and natural origin of stones.

Les couleurs des pierres s'entendent à titre indicatif. Des inclusions et légères différences de couleur parmi les mêmes confirment la pureté et le caractère naturel des pierres.

■ TEIDE GRANITO



Ecologico
PRODOTTO SENZA PIOMBO E NICKEL
CON OTTONE IN LEGA ANTIDIZINCIFICANTE
LEAD AND NICKEL FREE
BRASS ALLOY WITHOUT ZINC



Nicolazzi

■ CRISTALLO



Ecologico
PRODOTTO SENZA PIOMBO E NICHEL
CON OTTONE IN LEGA ANTIDIZINCIFICANTE
LEAD AND NICKEL FREE
BRASS ALLOY WITHOUT ZINC

MADE WITH
SWAROVSKI
ELEMENTS

Nicolazzi



MADE WITH
SWAROVSKI
ELEMENTS



MADE WITH
SWAROVSKI
ELEMENTS



MADE WITH
SWAROVSKI
ELEMENTS



CRISTALLO



Cristallo



2002 Gruppo vasca con doccia duplex
Bath tub set with duplex shower



2003 Gruppo vasca incasso erogazione a parete
Bath tub set, wall mtg. central "sail" spout



2004 Gruppo bordo vasca 4 fori
Bath tub mixer on edge type with 4 holes



2009 Batteria lavabo scarico automatico
Wash basin mixer with automatic pop-up waste



2010 Combinazione bidet
Bidet mixer with automatic pop-up waste



2015 Batteria per bidet esterna
Outer group for bidet



2011 Batteria bidet con doccetta
Bidet set with shower



2012 Rubinetto d'arresto incasso 1/2"
Built-in stop cock 1/2"



2032 Monoforo lavabo scarico automatico
Basin single-hole mixer with automatic pop-up waste



2034 Monoforo bidet scarico automatico
Bidet single-hole mixer with automatic pop-up waste

■ MONTEROSA



Ecologico
PRODOTTO SENZA PIOMBO E NICHEL
CON OTTONE IN LEGA ANTIDIZINCIFICANTE
LEAD AND NICKEL FREE
BRASS ALLOY WITHOUT ZINC

MADE WITH
SWAROVSKI
ELEMENTS

Nicolazzi



MONTEROSA





MONTEROSA





MONTEROSA



Monterosa



1801 Gruppo vasca esterno con doccia
Bathtub set with shower



1802 Gruppo vasca esterno con doccia duplex
Bathtub set with duplex shower



1803 Gruppo vasca incasso erogazione a parete
Bathtub set, wall mtg. central "sail" spout



1804 Gruppo bordo vasca 4 fori
Bathtub mixer on edge type with 4 holes



1808 Batteria lavabo scarico automatico
Wash basin mixer with automatic pop-up waste



1810 Combinazione bidet
Bidet mixer with automatic pop-up waste



1815 Batteria per bidet esterna
Outer group for bidet



1812 Rubinetto d'arresto incasso 1/2"
Built-in stop cock 1/2"



****30** Metal



****31** Ceramic



****32** Crystal

MADE WITH
SWAROVSKI
ELEMENTS

- HALF DOME CRYSTAL
- LIBERTY
- LIBERTY BLACK





MADE WITH
SWAROVSKI
ELEMENTS

HALF DOME CRYSTAL | LIBERTY | LIBERTY BLACK



Half Dome Crystal



1401 Gruppo vasca esterno con doccia
Bathtub set with shower



1403 Gruppo vasca incasso erogazione a parete
Bathtub set, wall mtg. central "sail" spout



1449 Gruppo bordo vasca 4 fori
Bathtub mixer on edge type with 4 holes



1409 Batteria lavabo scarico automatico
Wash basin mixer with automatic pop-up waste



1432 Monoforo lavabo scarico automatico, canna girevole
Basin single-hole mixer with swivel spout



1434 Monoforo bidet scarico automatico, canna girevole
Bidet single-hole mixer with swivel spout

MADE WITH
SWAROVSKI
ELEMENTS



****43 Liberty Black**

MADE WITH
SWAROVSKI
ELEMENTS



****93 Half Dome Crystal**

MADE WITH
SWAROVSKI
ELEMENTS



****34 Cristallo Liberty**

serie tradizionali

traditional series

CLASSICA LUSSO



DAMES ANGLAISES
HALF DOME
EL CAPITAN
PETIT MONT BLANC
FOREST
TOSA
CERAMICA NERA

MINIMALE



M. CROCE
MAC KINLEY 05

CLASSICA



NUOVA BRENTA
MONT BLANC
MAC KINLEY

Nicolazzi

- DAMES ANGLAISES
- HALF DOME
- EL CAPITAN
- PETIT MONT BLANC

- FOREST
- TOSA
- CERAMICA NERA





DAMES ANGLAISES | HALF DOME | EL CAPITAN | PETIT MONT BLANC | FOREST | TOSA | CERAMICA NERA

TRADIZIONALI





DAMES ANGLAISES | HALF DOME | EL CAPITAN | PETIT MONT BLANC | FOREST | TOSA | CERAMICA NERA

TRADIZIONALI









DAMES ANGLAISES | HALF DOME | EL CAPITAN | PETIT MONT BLANC | FOREST | TOSA | CERAMICA NERA

TRADIZIONALI













DAMES ANGLAISES | HALF DOME | EL CAPITAN | PETIT MONT BLANC | FOREST | TOSA | CERAMICA NERA

TRADIZIONALI



Dames Anglaises



1401 Gruppo vasca esterno con doccia
Bath tub set with shower



1403 Gruppo vasca incasso erogazione a parete
Bath tub set, wall mtg. central "sail" spout



1404 Gruppo bordo vasca 4 fori
Bath tub mixer on edge type with 4 holes



1449 Gruppo bordo vasca 4 fori
Bath tub mixer on edge type with 4 holes



1455 Gruppo lavello
Sink mixer wall mounted



1457 Gruppo lavello
Sink mixer wall mounted



1477 Batteria lavabo a parete
Wash basin wall mounted



1408 Batteria lavabo scarico automatico
Wash basin mixer with automatic pop-up waste



1409 Batteria lavabo scarico automatico
Wash basin mixer with automatic pop-up waste



1419 Gruppo a ponte
Bridge faucet



1415 Batteria per bidet esterna
Outer group for bidet



1432 Monoforo lavabo scarico automatico, canna girevole
Basin single-lever mixer with swivel spout



1434 Monoforo bidet scarico automatico, canna girevole
Bidet single-hole mixer with swivel spout



****18** Dames Anglaises



****70** Half Dome



****69** El Capitan



****78** P. M. Blanc

****78A** Antica / Antique



****78B** Ceramica Nera



****79** Forest



****07** Tosa

- M. CROCE
- MAC KINLEY 05







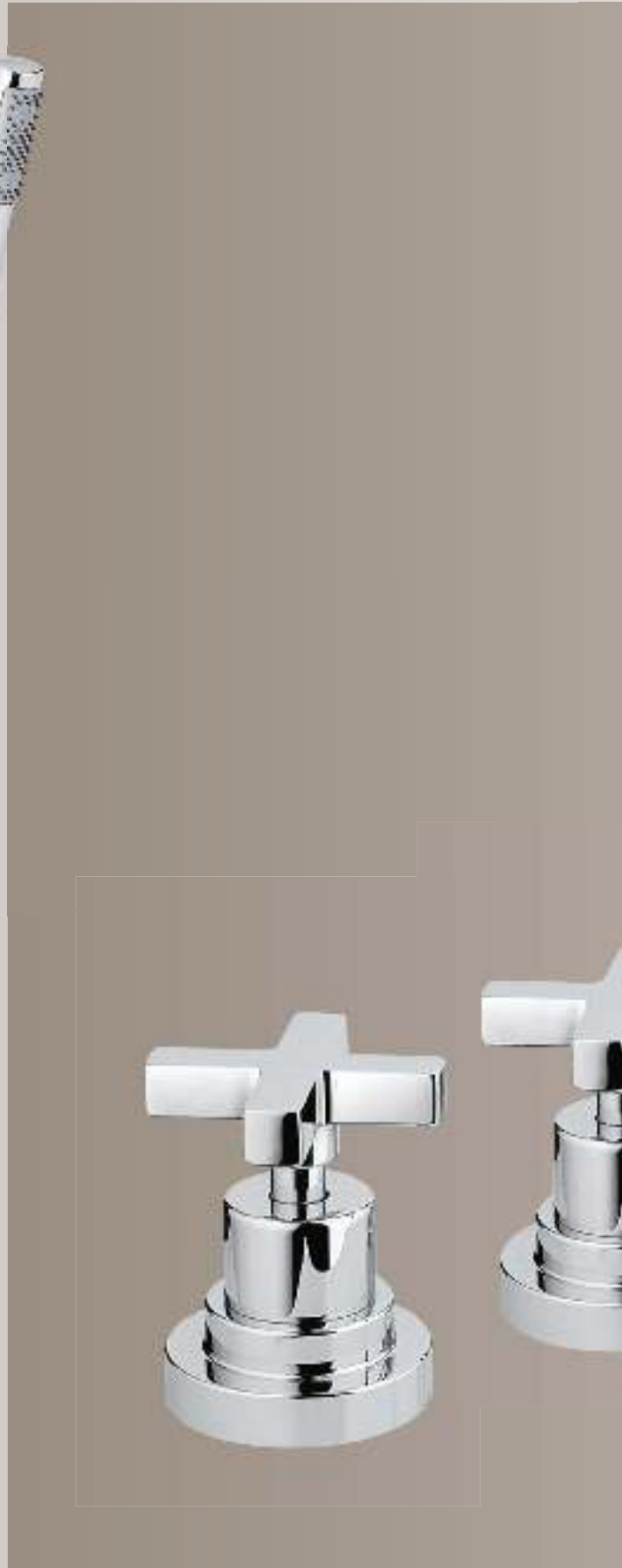







M. Croce



2202 Gruppo vasca con doccia duplex
Bathtub set with duplex shower



2203 Gruppo vasca incasso erogazione a parete
Bathtub set, wall mtg. central "sail" spout



2225 Gruppo doccia esterno (senza flex e doccia)
Shower mixer external type, without duplex



2207 Batteria lavabo a parete
Wash basin wall mounted



2208 Batteria lavabo scarico automatico
Wash basin mixer with automatic pop-up waste



2210 Combinazione bidet
Bidet mixer with automatic pop-up waste



2215 Batteria bidet esterna
Outer group for bidet



2211 Batteria bidet con doccetta
Bidet set with shower



2212 Rubinetto d'arresto incasso 1/2"
Built-in stop cock 1/2"



2236 Monoforo lavabo scarico automatico
Basin single-hole mixer with automatic pop-up waste



2237 Monoforo bidet scarico automatico
Bidet single-hole mixer with automatic pop-up waste



2214 Gruppo bordo vasca 5 fori
Bathtub mixer on edge type with 5 holes



****27** M.Croce



****29** Mac Kinley 05

- NUOVA BRENTA
- MONT BLANC
- MAC KINLEY















Nuova Brenta



2501 Gruppo vasca con doccia
Bathtub set with shower



2502 Gruppo vasca esterno
con doccia duplex
Bathtub set with duplex
shower



2503 Gruppo vasca incasso
erogazione a parete
Bathtub set, wall mtg. central
"sail" spout



2525 Gruppo doccia esterno
(senza flex e doccia)
Shower mixer external type,
without duplex



2504 Gruppo bordo vasca 4 fori
Bathtub mixer on edge type
with 4 holes



2505 Gruppo lavello
Sink mixer wall mounted



2507 Batteria lavabo canna alta
girevole
Wash-basin mixer with
swinging spout



2508 Batteria lavabo scarico
automatico
Wash basin mixer with
automatic pop-up waste



2509 Batteria lavabo bocca
a colonna
Wash basin mixer with
column spout



2510 Combinazione bidet
Bidet mixer with automatic
pop-up waste



2515 Batteria per bidet esterna
Outer group for bidet



2511 Batteria bidet con doccia
e scarico automatico
Bidet set with shower and
automatic pop-up waste



2532 Monoforo lavabo scarico
automatico
Basin single-hole mixer
with automatic pop-up waste



2534 Monoforo bidet scarico
automatico
Bidet single-hole mixer
with automatic pop-up waste



2536 Monoforo lavabo con
canna girevole
Wash basin single-hole
mixer with swinging spout



2537 Monoforo bidet con
canna girevole
Bidet single-hole
mixer with swinging spout



2538 Monoforo lavabo scarico
automatico
Basin single-hole mixer
with automatic pop-up waste



Nuova Brenta



Mont Blanc



Mac Kinley

serie monocomandi

single-lever series

■ CLASSICA LUSO



CINQUANTA
EL CAPITAN
PETIT MONT BLANC
FOREST
CERAMICA NERA
DECORATED CERAMICS
CRISTALLO
LIBERTY BLACK

■ MINIMALE



ANTELAO
OLYMPUS

■ DESIGN



VINCENT (vedi Extra Lusso)
JUNGFRAU
DIAMIR 2
SIGNAL

■ CLASSICA



DOM

Nicolazzi

■ CINQUANTA



Ecologico
PRODOTTO SENZA PIOMBO E NICHEL
CON OTTONE IN LEGA ANTIDIZINCIFICANTE
LEAD AND NICKEL FREE
BRASS ALLOY WITHOUT ZINC

Nicolazzi



MONOCOMANDO CINQUANTA





MONOCOMANDO CINQUANTA





MONOCOMANDO **CINQUANTA**



monocomando Cinquanta



3400 *Monocomando vasca incasso*
Built-in bath mixer delivery
spout on wall



3401 *Monocomando vasca esterno
con doccia*
Single-lever bath mixer with
shower



3452 *Monocomando per lavabo
con scarico automatico*
Single-lever wash basin mixer



3453 *Monocomando per bidet
con scarico automatico*
Single-lever bidet mixer



3454 *Monocomando per lavabo
con scarico automatico*
Single-lever wash basin mixer



3455 *Monocomando per bidet
con scarico automatico*
Single lever bidet mixer



3405 *Monocomando doccia esterno*
Single-lever shower mixer,
external wall type



3406 *Monocomando doccia incasso*
Single-lever for built-in shower



3460 *Monocomando doccia incasso
con deviatore*
Single-lever built-in shower
diverter



3449 *Monocomando bordo vasca*
Single-lever bath mixer on
edge type

****76** P. Mont Blanc

****76A** P. Mont Blanc
Ceramica anticata
Antique ceramic

****76B** Ceramica nera

****46** Decorated
ceramics



****33** Cristallo

****40** Liberty Black

****75** El Capitan

****77** Forest

MADE WITH
SWAROVSKI
ELEMENTS



MADE WITH
SWAROVSKI
ELEMENTS



■ EL CAPITAN

■ PETIT MONT BLANC

■ FOREST

■ CRISTALLO

■ LIBERTY BLACK

■ CERAMICA NERA

■ DECORATED
CERAMICS







monocomando *Classico*



3400 *Monocomando vasca incasso*
Built-in bath mixer delivery
spout on wall



3401 *Monocomando vasca esterno
con doccia*
Single-lever bath mixer with
shower



3402 *Monocomando per lavabo
con scarico automatico*
Single-lever wash basin mixer



3403 *Monocomando per bidet
con scarico automatico*
Single-lever bidet mixer



3471 *Monocomando lavabo*
Single-lever wash basin mixer



3472 *Monocomando lavabo alto*
Single-lever high wash
basin mixer



3404 *Monocomando lavello
a parete*
Single-lever sink mixer,
wall mounted



3405 *Monocomando doccia esterno*
Single-lever shower mixer,
external wall type



3406 *Monocomando doccia incasso*
Single-lever for built-in shower



3460 *Monocomando doccia incasso
con deviatore*
Single-lever built-in shower
diverter



3414 *Monocomando bordo vasca*
Single-lever bath mixer on
edge type

****76** P. Mont Blanc



****76A** P. Mont Blanc
Ceramica anticata
Antique ceramic



****76B** Ceramica nera



****46** Decorated
ceramics



****33** Cristallo



****40** Liberty Black



****75** El Capitan



****77** Forest



■ ANTELAO



Ecologico
PRODOTTO SENZA PIOMBO E NICHEL
CON OTTONE IN LEGA ANTIDIZINCIFICANTE
LEAD AND NICKEL FREE
BRASS ALLOY WITHOUT ZINC

Nicolazzi



MONOCOMANDO **ANTELAO**



monocomando Antelao



3801 *Monocomando vasca esterno con doccia*
Single-lever bath mixer with shower



3802 *Monocomando per lavabo con scarico automatico*
Single-lever wash basin mixer



3872 *Monocomando per lavabo alto*
Single-lever high basin mixer



3803 *Monocomando per bidet con scarico automatico*
Single-lever bidet mixer



3806 *Monocomando doccia incasso*
Single-lever for built-in shower



3825 *Monocomando doccia esterno*
Single-lever shower mixer, external wall type

■ OLYMPUS



Ecologico
PRODOTTO SENZA PIOMBO E NICHEL
CON OTTONE IN LEGA ANTIDIZINCIFICANTE
LEAD AND NICKEL FREE
BRASS ALLOY WITHOUT ZINC

Nicolazzi



MONOCOMANDO **OLYMPUS**





MONOCOMANDO **OLYMPUS**





MONOCOMANDO **OLYMPUS**



monocomando Olympus



3701 *Monocomando vasca esterno con doccia*
Single-lever bath mixer with shower



3702 *Monocomando per lavabo con scarico automatico*
Single-lever wash basin mixer



3772 *Monocomando per lavabo alto*
Single-lever high basin mixer



3703 *Monocomando per bidet con scarico automatico*
Single-lever bidet mixer



3706 *Monocomando doccia incasso*
Single-lever for built-in shower



3796 *Monocomando doccia incasso con deviatore*
Single-lever for built-in shower with diverter



3725 *Monocomando doccia esterno*
Single-lever shower mixer, external wall type



3777 *Monocomando lavabo incasso*
Single-lever wall mounted basin mixer

■ JUNGFRAU



Ecologico
PRODOTTO SENZA PIOMBO E NICHEL
CON OTTONE IN LEGA ANTIDIZINCIFICANTE
LEAD AND NICKEL FREE
BRASS ALLOY WITHOUT ZINC

Nicolazzi



MONOCOMANDO JUNGFRAU



monocomando Jungfrau



3101 *Monocomando vasca esterno con doccia*
Single-lever bath mixer with shower



3102 *Monocomando per lavabo con scarico automatico*
Single-lever bath basin mixer



3103 *Monocomando per bidet con scarico automatico*
Single-lever bidet mixer



3106 *Monocomando doccia incasso*
Single-lever for built-in shower



3196 *Monocomando doccia incasso con deviatore*
Single-lever for built-in shower with diverter



3125 *Monocomando doccia esterno*
Single-lever shower mixer, external wall type

■ DIAMIR 2



Ecologico
PRODOTTO SENZA PIOMBO E NICHEL
CON OTTONE IN LEGA ANTIDIZINCIFICANTE
LEAD AND NICKEL FREE
BRASS ALLOY WITHOUT ZINC

Nicolazzi



MONOCOMANDO **DIAMIR 2**



monocomando **Diamir 2**



3521 *Monocomando vasca esterno con doccia*
Single-lever bath mixer with shower



3522 *Monocomando per lavabo con scarico automatico*
Single-lever wash basin mixer



3523 *Monocomando per bidet con scarico automatico*
Single-lever bidet mixer



3526 *Monocomando doccia incasso*
Single-lever for built-in shower



3524 *Monocomando bordo vasca*
Single-lever bath mixer on edge type



■ SIGNAL



Ecologico
PRODOTTO SENZA PIOMBO E NICHEL
CON OTTONE IN LEGA ANTIDIZINCIFICANTE
LEAD AND NICKEL FREE
BRASS ALLOY WITHOUT ZINC

Nicolazzi



MONOCOMANDO **SIGNAL**



monocomando Signal



3400 *Monocomando vasca incasso*
Built-in bath mixer delivery
spout on wall



3401 *Monocomando vasca esterno
con doccia*
Single-lever bath mixer with
shower



3402 *Monocomando per lavabo
con scarico automatico*
Single-lever wash basin mixer



3403 *Monocomando per bidet
con scarico automatico*
Single-lever bidet mixer



3404 *Monocomando lavello
a parete*
Single-lever sink mixer,
wall mounted



3405 *Monocomando doccia esterno*
Single-lever shower mixer,
external wall type



3406 *Monocomando doccia incasso*
Single-lever for built-in shower



3460 *Monocomando doccia incasso
con deviatore*
Single-lever bath-in-shower
with diverter



3466 *Monocomando doccia incasso
"Unico"*
Single-lever for built-in shower
"Unico"



3414 *Monocomando bordo vasca*
Single-lever bath mixer on
edge type



■ DOM



Ecologico
PRODOTTO SENZA PIOMBO E NICKEL
CON OTTONE IN LEGA ANTIDIZINCIFICANTE
LEAD AND NICKEL FREE
BRASS ALLOY WITHOUT ZINC

Nicolazzi



MONOCOMANDO **DOM**



monocomando Dom



4300 *Monocomando vasca incasso*
Built-in bath mixer delivery
spout on wall



4301 *Monocomando vasca esterno
con doccia*
Single-lever bath mixer with
shower



4302 *Monocomando per lavabo
con scarico automatico*
Single-lever wash basin mixer



4303 *Monocomando per bidet
con scarico automatico*
Single-lever bidet mixer



4304 *Monocomando lavello
a parete*
Single-lever sink mixer,
wall mounted

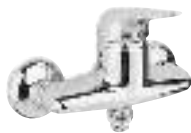

4305 *Monocomando doccia esterno*
Single-lever shower mixer,
external wall type



4306 *Monocomando doccia incasso*
Single-lever for built-in shower



4360 *Monocomando doccia incasso
con deviatore*
Single-lever built-in shower
diverter



4366 *Monocomando doccia incasso
"Unico"*
Single-lever for built-in shower
"Unico"



4314 *Monocomando bordo vasca*
Single-lever bath mixer on
edge type

■ TERMOSTATICO



Nicolazzi



TERMOSTATICO



Art. 4911

ATTENZIONE

L'articolo 4913 deve sempre essere abbinato all'articolo 4911.

ATTENTION

Item 4913 must be always installed with item 4911.

Art. 4913

MIN 60
MAX 100

VALVOLA NON-RITORNO

67
CALDO
G 3/4"

VALVOLA NON-RITORNO

32.5
46
FREDDO

TERMOSTATICO

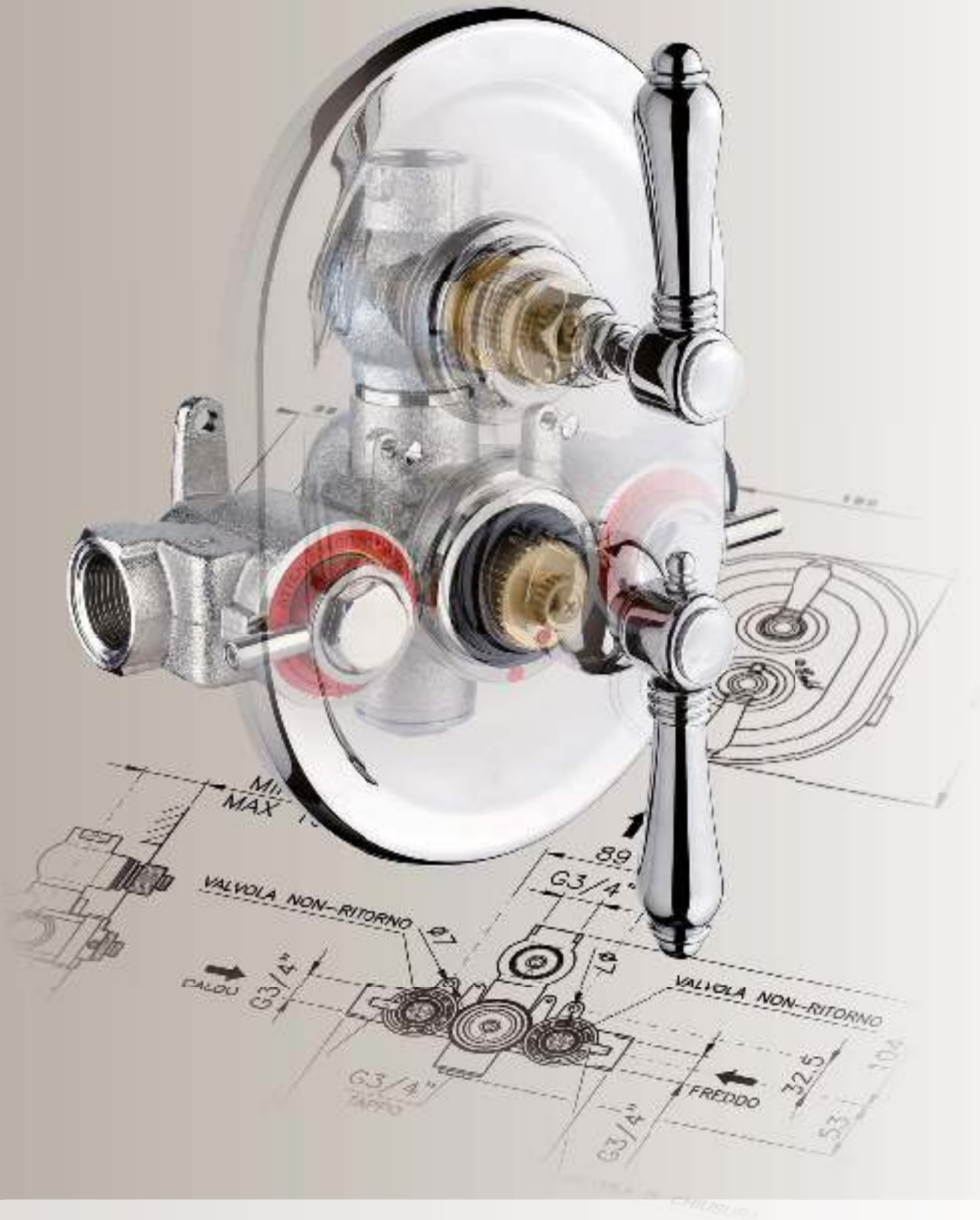



TERMOSTATICO

Art. 4911

**ATTENZIONE**

L'articolo 4913 deve sempre essere abbinato all'articolo 4911.

ATTENTION

Item 4913 must be always installed with item 4911.

Art. 4913



termostatico



4909 *Parte esterna termostatico a incasso da 3/4" con arresto*
Ext. type built-in therm. 3/4"
with stop cock



4914 *Parte esterna termostatico a incasso da 3/4" senza arresto*
Ext. type built-in therm. 3/4"
without stop cock



4912 *Parte esterna rubinetto arresto incasso 3/4"*
External part built-in stop
cock 3/4"



4905 *Miscelatore termostatico esterno doccia moderno*
Thermostatic shower mixer,
external type modern style



4917 *Miscelatore termostatico esterno doccia classico*
Thermostatic shower mixer
external type classic style



4909 *Parte esterna termostatico a incasso da 3/4" con arresto*
Ext. type built-in therm. 3/4"
with stop cock



Pumori CR83
4909 *Parte esterna termostatico a incasso da 3/4" con arresto*
Ext. type built-in therm. 3/4"
with stop cock



M.Croce CR27
4914 *Parte esterna termostatico a incasso da 3/4" senza arresto*
Ext. type built-in therm. 3/4"
without stop cock



Mac Kinley 05 CR29
4912 *Parte esterna rubinetto arresto incasso 3/4"*
External part built-in stop
cock 3/4"

INFORMAZIONI TECNICHE

TECHNICAL INFORMATION - INFORMATIONS TÉCNIQUES - TECHNISCHE INFORMATIONEN



Art. 4810



Art. 4913



Art. 4917

Questo articolo deve sempre essere abbinato all'art. 4911
This article must always be coupled with art. 4911

INFORMAZIONI TECNICHE

TEMPERATURA DI ALIMENTAZIONE ACQUA CALDA

Minima: 48°C
Massima: 85°C
Consigliata: 60°C

PRESSIONE DI ALIMENTAZIONE

Minima: 1 bar
Massima: 5 bar
Consigliata: 3 bar

IMPORTANTE:

Le pressioni di alimentazione dell'acqua calda e fredda devono essere uguali.
Differenza massima accettata fra le due pressioni: 1 bar.

PORTATA

33 l/min a 2,5 bar

TARATURA DI FABBRICA DELLA CARTUCCIA TERMOSTATICA 38°C.

Parametri di taratura.
Acqua calda: 60°C/3 bar
Acqua fredda: 15°C/3 bar

ATTACCHI

Entrata acqua calda e fredda = G 3/4"
Uscita doccia e vasca = G 3/4"

DISPOSITIVI DI SICUREZZA

Blocco manuale della temperatura a 38°.
Blocco automatico erogazione acqua in caso di mancanza di acqua fredda o acqua calda.
Valvole anti-ritorno e sistema filtrante interno ispezionabili anche dopo il montaggio.

TECHNICAL INFORMATION

HOT WATER TEMPERATURE

Minimum: 48°C
Maximum: 85°C
Recommended: 60°C

PRESSURE

Minimum: 1 bar
Maximum: 5 bar
Recommended: 3 bar

IMPORTANT:

The pressure alimentation of hot and cold water have to be the same.
Maximum difference accepted between the two pressures: 1 bar.

FLOW RATE

33 l/m at 2.5 bar

FACTORY SETTING OF THE THERMOSTATIC CARTRIDGE 38°C

Setting test conditions:
Hot water: 60°C/3 bar
Cold water: 15°C/3 bar

CONNECTION DIMENSIONS

Hot and cold water inlets = 3/4" G
Shower and tub outlet = 3/4" G

SAFETY INFORMATION

Manual stop temperature at 38°C.
Automatic stop of the water in case of cold water lack.
Check valves and filters inside.

INFORMATIONS TÉCNIQUES

TEMPERATURE D'ALIMENTATION DE L'EAU CHAUDE

Minimum: 48°C
Maximum: 85°C
Conseillé: 60°C

PRESSION D'ALIMENTATION

Minimum: 1 bar
Maximum: 5 bar
Conseillé: 3 bar

IMPORTANT:

les pressions d'alimentation de l'eau chaude et froide doivent être les mêmes.
La différence au maximum acceptée est de 1 bar.

CAPACITÉ

33 l/min à 2,5 bar

ÉTALLONAGE DE L'USINE DE LA CARTOUCHE THERMOSTATIQUE 38°C

Paramètres d'étallonnage
Eau chaude: 60°C/3 bar
Eau Froide: 15°C/3 bar

ATTAQUES

Entrée de l'eau chaude et froide = G 3/4"
Sortie mélangeur douche et bain = G 3/4"

DISPOSITIFS DE SECURITÉ

Bloc manuel de la température à 38 °C.
Bloc automatique de l'eau de distribution en cas de manque de l'eau froide ou de l'eau chaude.
Soupape auto-retour et arrange inspectable intérieur disjoint également après l'assemblage.

TECHNISCHE INFORMATIONEN

TEMPERATUR DES EINZIEHEN DES WARMEN WASSER

Minimum: 48°C
Maximum: 85°C
Fähigkeit: 60°C

ERHÖHUNG DRUCK

Minimum: 1 bar
Maximum: 5 bar
Fähigkeit: 3 bar

WICHTIG:

der Erhöhung Druck des warmen und kalten Wassers muß gleich sein.
Der geltende maximale Unterschied zwischen dem zwei Druck: 1 bar

KAPAZITÄT

33 l/min an 2,5 bar

KALIBRIERUNG DER FABRIK DER THERMOSTATISCHEN KARTUSCHE 38°C

Parameter der Kalibrierung
Warm Wasser: 60°C/3 bar
Kalt Wasser: 15°C/3 bar

ANGRIFF

Eingang warmes und kaltes Wasser = G 3/4"
Ausgang Dusche und Badewanne = G 3/4"

EINHEIT DER DRINGLICHKEIT

Manueller Block des Gewehr-Verteilung Wassers des Temperaturblockes.
Automatischen im kalten Wasser des Mangelfalles oder in den warmen. Wasserventilen der Nichrückgabe und ordnet undichtet inneres.

TERMOSTATICO

Tutte queste leve e maniglie possono essere abbinare alla parte esterna del termostatico **4909**.
Sostituire agli asterischi rossi le due cifre in rosso.

All these levers and handles can be bound together to the external part of the therm. **4909**. Replace to the red asterisks the two figures in red.
Tous ces leviers et manettes peuvent être liés ensemble à la partie externe du mélangeur **4909**. Remplacez aux astérisques en rouge les deux chiffres en rouge.
Alle diese Hebel und Handgriffe können zum externen Teil des Sperrventil zusammen gesprungen werden **4909**. Ersetzen Sie zu den Rotsternchen die zwei Abbildungen im Rot.
Todos estas palancas y manijas se pueden limitar juntas a la parte externa del mezclador termost. **4909** Substituya a los asteriscos en rojo, los dos números en rojo.
Todos estes alavancas e punhos podem ser limitados junto à parte externa da misturador termost. **4909**. Substitua aos asteriscos do vermelho as duas figuras no vermelho.

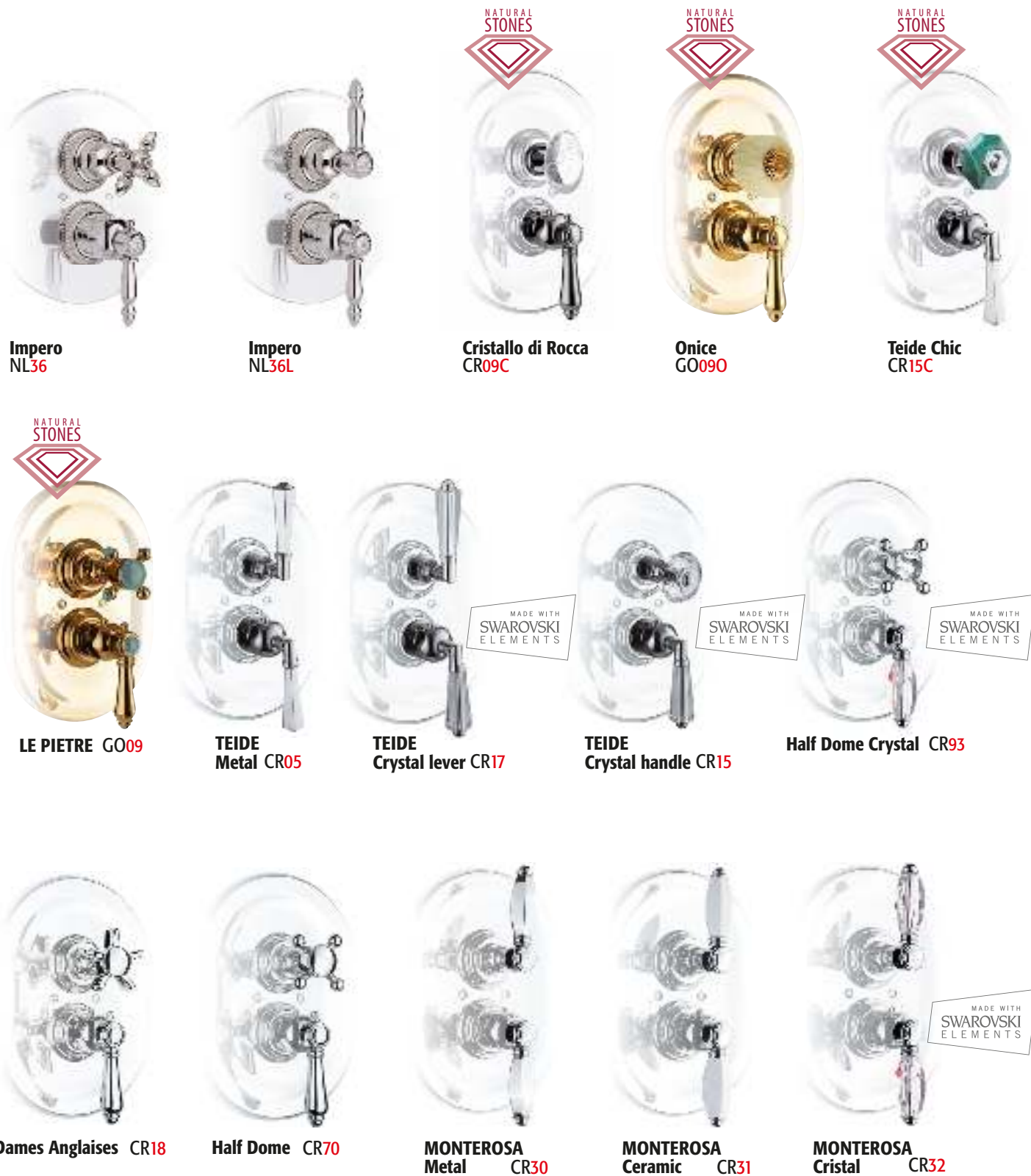

TERMOSTATICO

**El Capitan CR69****Petit M. Blanc CR78****Petit M. Blanc CR78A
Anticata / Antique****Forest CR79****Cristallo Liberty CR34**MADE WITH
SWAROVSKI
ELEMENTS**Ceramica Nera
CR78B****TEIDE Decorated
Ceramics CR39****TEIDE White
Ceramics CR39W****TEIDE
Granito CR06G****TEIDE
Four CR45****Liberty Black
CR43**MADE WITH
SWAROVSKI
ELEMENTS

Tutte queste leve e maniglie possono essere abbinare alla parte esterna del termostatico **4914**.
Sostituire agli asterischi rossi le due cifre in rosso.

All these levers and handles can be bound together to the external part of the therm. **4914**. Replace to the red asterisks the two figures in red.
Tous ces leviers et manettes peuvent être liés ensemble à la partie externe du mélangeur **4914**. Remplacez aux astérisques en rouge les deux chiffres en rouge.
Alle diese Hebel und Handgriffe können zum externen Teil des Sperrventil zusammen gesprungen werden **4914**. Ersetzen Sie zu den Rotsternchen die zwei Abbildungen im Rot.
Todos estas palancas y manijas se pueden limitar juntas a la parte externa del mezclador termost. **4914** Sustituya a los asteriscos en rojo, los dos números en rojo.
Todos estes alavancas e punhos podem ser limitados junto à parte externa da misturador termost. **4914**. Substitua aos asteriscos do vermelho as duas figuras no vermelho.

**IMPERO NL36L****LE PIETRE GO09****TEIDE
Metal CR05****TEIDE
Crystal lever CR17**MADE WITH
SWAROVSKI
ELEMENTS**MONTEROSA
Metal CR30****MONTEROSA
Ceramic CR31****MONTEROSA
Crystal CR32**MADE WITH
SWAROVSKI
ELEMENTS

TERMOSTATICO



MONTEROSA
Metal CR30



MONTEROSA
Ceramic CR31



MONTEROSA
Crystal CR32



El Capitan CR69



Petit M. Blanc CR78



Petit M. Blanc CR78A
Anticata / Antique



Forest CR79



Cristallo Liberty CR34



Ceramica Nera
CR78B



Decorated
Ceramics CR39



TEIDE White
Ceramics CR39W



TEIDE
Granito CR06G



Liberty Black
CR43



Tutte queste leve e maniglie possono essere abbinare alla parte esterna del rubinetto arresto **4912**.
Sostituire agli asterischi rossi le due cifre in rosso.

All these levers and handles can be bound together to the external part of the stop cock **4912**. Replace to the red asterisks the two figures in red.
Tous ces leviers et manettes peuvent être liés ensemble à la partie externe du robinet arrêt **4912**. Remplacez aux astérisques en rouge les deux chiffres en rouge.
Alle diese Hebel und Handgriffe können zum externen Teil des Sperrventil zusammen gesprungen werden **4912**. Ersetzen Sie zu den Rotsternen die zwei Abbildungen im Rot.
Todas estas palancas y manijas se pueden limitar juntas a la parte externa de la detención del grifo de cierre **4912** Substituya a los asteriscos en rojo los dos números en rojo.
Todos estes alavancas e punhos podem ser limitados junto à parte externa da torneira de parada **4912**. Substitua aos asteriscos do vermelho as duas figuras no vermelho.



IMPERO NL36



IMPERO NL36L



CRISTALLO DI
ROCCA GO9C



ONICE GO90



TEIDE CHIC GO15C



LE PIETRE GO09



TEIDE Crystal
handle CR15



Dames Anglaises
CR18



Half Dome
CR70



Half Dome
Crystal CR93

TERMOSTATICO



**TEIDE
Four CR45**



**TEIDE Metal
CR05**



**TEIDE White
Ceramics CR39W**



**TEIDE Granito
CR06G**



**TEIDE Full Decorated
Ceramics CR06D**



**TEIDE Full White
Ceramics CR06W**



**TEIDE Crystal
lever CR17**

MADE WITH
SWAROVSKI
ELEMENTS



El Capitan CR69



**Petit M. Blanc
CR78**



**Petit M. Blanc CR78A
Anticata / Antique**



**MONTEROSA
Metal CR30**



**MONTEROSA
Ceramic CR31**



**MONTEROSA
Crystal CR32**

MADE WITH
SWAROVSKI
ELEMENTS



Forest CR79



**Cristallo Liberty
CR34**

MADE WITH
SWAROVSKI
ELEMENTS



**Ceramica Nera
CR78B**



**TEIDE Decorated
Ceramics CR39**



**Liberty Black
CR43**

MADE WITH
SWAROVSKI
ELEMENTS



TERMOSTATICO

Tutte queste leve e maniglie possono essere abbinate alla parte esterna del termostatico 4909.
Sostituire agli asterischi rossi le due cifre in rosso.

All these levers and handles can be bound together to the external part of the therm. 4909. Replace to the red asterisks the two figures in red.
 Tous ces leviers et manettes peuvent être liés ensemble à la partie externe du mélangeur 4909. Remplacez aux astérisques en rouge les deux chiffres en rouge.
 Alle diese Hebel und Handgriffe können zum externen Teil des Sperrventil zusammen gesprungen werden 4909. Ersetzen Sie zu den Rotsternenchen die zwei Abbildungen im Rot.
 Todos estas palancas y manijas se pueden limitar juntas a la parte externa del mezclador termost. 4909 Substituya a los asteriscos en rojo, los dos números en rojo.
 Todos estes alavancas e punhos podem ser limitados junto à parte externa da misturador termost. 4909. Substitua aos asteriscos do vermelho as duas figuras no vermelho.



Margherita CR38



Vincent CR28



Pumori CR83



M.Croce CR27



Mac Kinley 05 CR29

Tutte queste leve e maniglie possono essere abbinate alla parte esterna del termostatico 4914.
Sostituire agli asterischi rossi le due cifre in rosso.

All these levers and handles can be bound together to the external part of the therm. 4914. Replace to the red asterisks the two figures in red.
 Tous ces leviers et manettes peuvent être liés ensemble à la partie externe du mélangeur 4914. Remplacez aux astérisques en rouge les deux chiffres en rouge.
 Alle diese Hebel und Handgriffe können zum externen Teil des Sperrventil zusammen gesprungen werden 4914. Ersetzen Sie zu den Rotsternenchen die zwei Abbildungen im Rot.
 Todos estas palancas y manijas se pueden limitar juntas a la parte externa del mezclador termost. 4914 Substituya a los asteriscos en rojo, los dos números en rojo.
 Todos estes alavancas e punhos podem ser limitados junto à parte externa da misturador termost. 4914. Substitua aos asteriscos do vermelho as duas figuras no vermelho.



Margherita CR38



Vincent CR28



Pumori CR83



M.Croce CR27



Mac Kinley 05 CR29

Tutte queste leve e maniglie possono essere abbinate alla parte esterna del rubinetto arresto 4912.
Sostituire agli asterischi rossi le due cifre in rosso.

All these levers and handles can be bound together to the external part of the stop cock 4912. Replace to the red asterisks the two figures in red.
 Tous ces leviers et manettes peuvent être liés ensemble à la partie externe du robinet arrêt 4912. Remplacez aux astérisques en rouge les deux chiffres en rouge.
 Alle diese Hebel und Handgriffe können zum externen Teil des Sperrventil zusammen gesprungen werden 4912. Ersetzen Sie zu den Rotsternenchen die zwei Abbildungen im Rot.
 Todos estas palancas y manijas se pueden limitar juntas a la parte externa de la detención del grifo de cierre 4912. Substituya a los asteriscos en rojo, los dos números en rojo.
 Todos estes alavancas e punhos podem ser limitados junto à parte externa da torneira de parada 4912. Substitua aos asteriscos do vermelho as duas figuras no vermelho.



Margherita CR38



Vincent CR28



Pumori CR83



M. Croce CR27



Mac Kinley 05 CR29

PROGRAMMA CUCINA



Ecologico
PRODOTTO SENZA PIOMBO E NICKEL
CON OTTONE IN LEGA ANTIDIZINCIFICANTE
LEAD AND NICKEL FREE
BRASS ALLOY WITHOUT ZINC

Nicolazzi



PROGRAMMA CUCINA









PROGRAMMA CUCINA



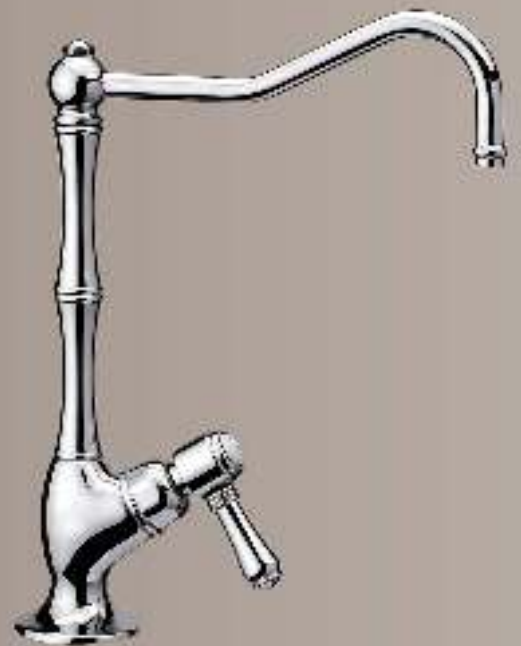































Programma Cucina

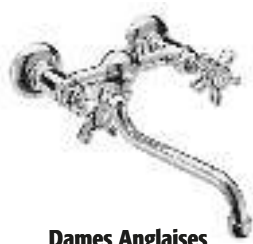

Dames Anglaises

1455 Gruppo lavello
Sink mixer wall mounted



Dames Anglaises

1469 Monoforo lavello
Single-hole sink mixer



El Capitan

1457 Gruppo lavello
Sink mixer wall mounted



El Capitan

1406WS Monoforo lavello canna
girevole con doccia estraibile
Single-hole sink mixer
with side spray



Dames Anglaises

1459 Gruppo lavello
Sink mixer



Petit Mont Blanc

1460 Gruppo lavello
Sink mixer



Half Dome

1451 Rubinetto cucina snodato
con arresto
Folding kitchen faucet
with stop cock



Dames Anglaises

1452 Rubinetto cucina snodato
con arresto
Folding kitchen faucet
with stop cock



El Capitan

1435 Rubinetto singolo per filtro
canna a colonna
Filter tap column spout



M.Croce

2206 Monoforo lavello
Single-hole sink mixer



Cinquanta

3450WS Monocomando lavello canna
girevole con doccia estraibile
One-hole sink mixer with side
spray



El Capitan

3407 Monocomando lavello
girevole con doccia estraibile
Sink set single-lever mixer
pivoting tube



Signal

3404 Monocomando lavello
a parete
Single lever sink mixer
wall mounted



Dom

4310 Monocomando lavello con
doccia estraibile
Single-lever mixer with
extractable shower



3710 Monocomando lavello
minimale doccia estraibile
Sink set single-lever mixer
pivoting tube



3711 Monoc. lavello con canna
a molla, doccia estraibile
One-hole sink mixer with
side spray



3712 Monocomando lavello
abbattibile
Single-lever mixer foldable

accessori bagno

bathroom accessories

■ EXTRA LUSSO



■ MINIMALE



■ CLASSICA



■ CERAMICA



Nicolazzi

accessori bagno Impero



1481 *Appendiabiti*
Clothes-hanger



1483 *Portasalvietta cm. 30*
Towel holder cm. 30

1484 *Portasalvietta cm. 45*
Towel holder cm. 45

1486 *Portasalvietta cm. 60*
Towel holder cm. 60



1487 *Portasapone*
Soap holder



1488 *Portabicchiere*
Tumbler holder

accessori bagno

■ IMPERO



accessori bagno

■ CRISTALLO DI ROCCA



accessori bagno

■ ONICE



accessori bagno

■ TEIDE CHIC



- VINCENT
- MARGHERITA



Nicolazzi



ACCESSORI BAGNO



accessori bagno Vincent - Margherita



1081 *Appendiabiti*
Clothes-hanger



1083 *Portasalvietta cm. 24*
Towel holder cm. 24

1084 *Portasalvietta cm. 39*
Towel holder cm. 39

1086 *Portasalvietta cm. 54*
Towel holder cm. 54



1087 *Portasapone*
Soap holder



1088 *Portabicchiere*
Tumbler holder



1089 *Dosasapone*
Soap dispenser holder



1092 *Portarotolo*
Paper holder

■ MINIMALE
collection



Nicolazzi

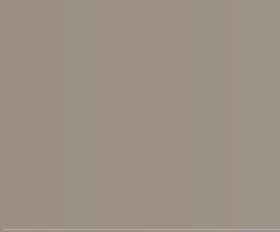

ACCESSORI BAGNO

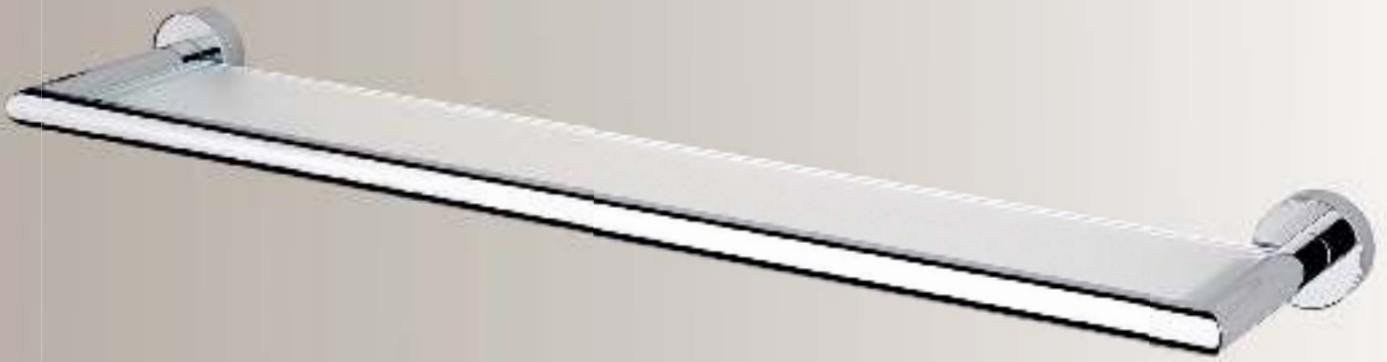
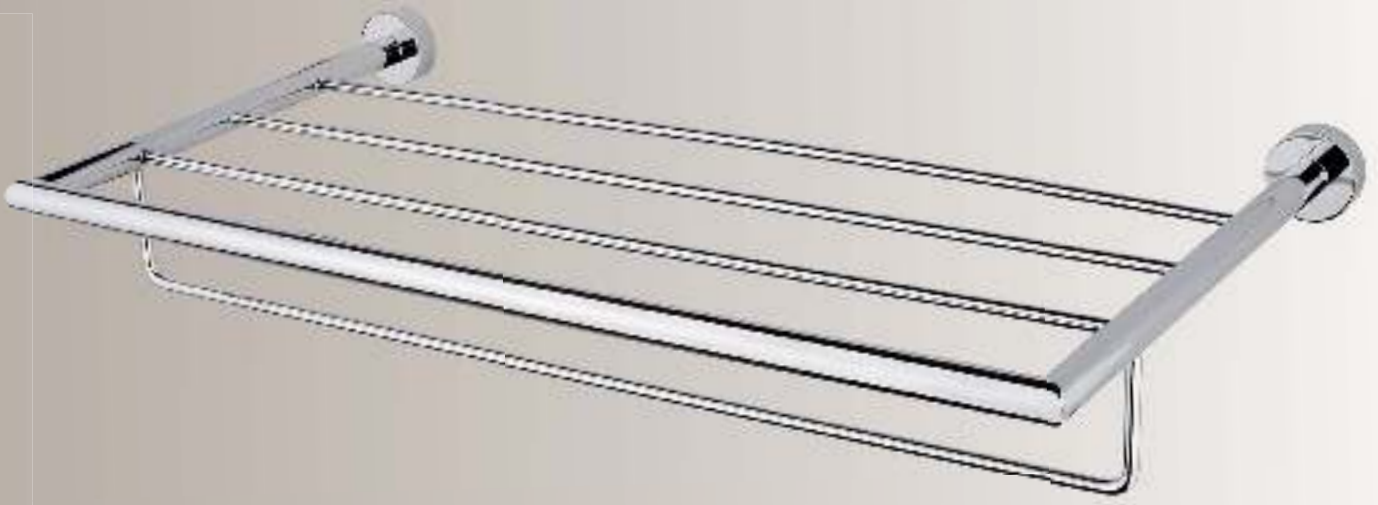

accessori bagno **minimale**



1480M *Mensola cm. 50*
Shelf cm. 50



1481M *Appendiabiti*
Clothes-hanger



1482M *Portasalvietta a snodo*
Jointed towel holder



1483M *Portasalvietta cm. 30*
Towel holder cm. 30

1484M *Portasalvietta cm. 45*
Towel holder cm. 45

1486M *Portasalvietta cm. 60*
Towel holder cm. 60



1487M *Portasapone*
Soap holder



1488M *Portabicchiere*
Tumbler holder



1489M *Dosasapone*
Soap dispenser holder



1490M *Portascopino a parete*
Wall toilet brush holder



1492M *Portarotolo*
Paper holder



1497M *Portarotolo verticale*
Spare paper holder



1499M *Griglia portasalviette*
Towels rack

■ CLASSICA
collection



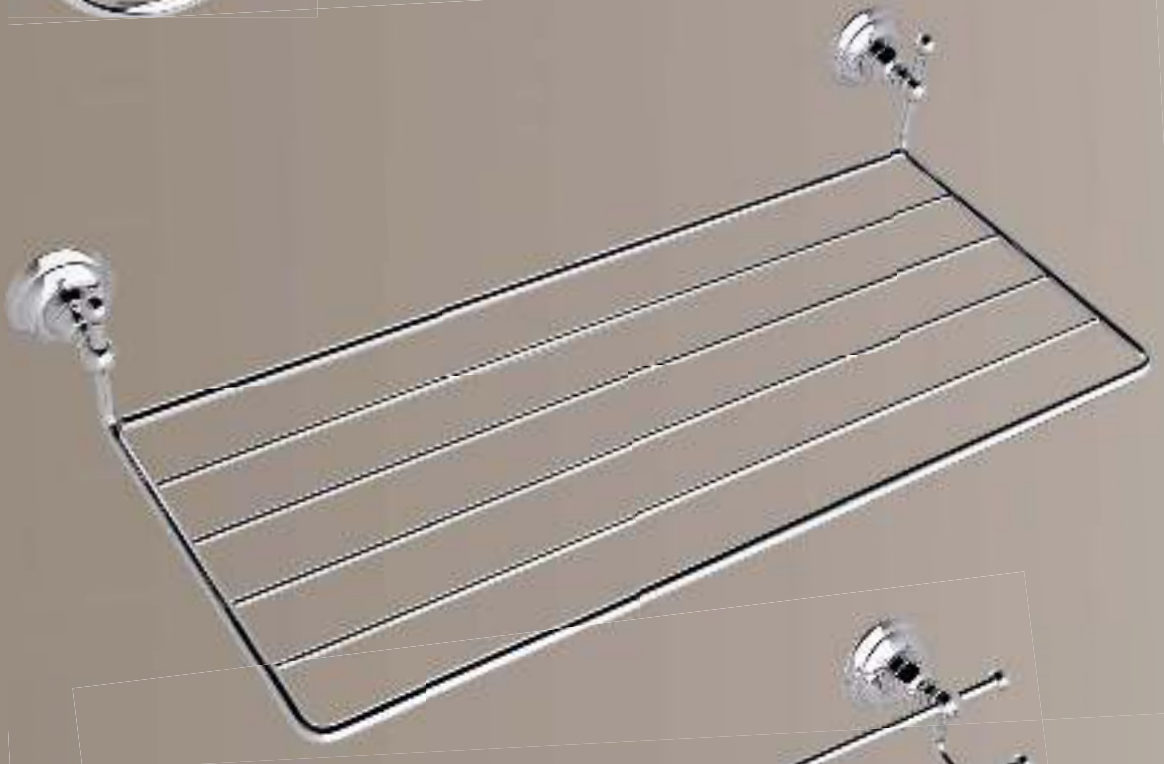

ACCESSORI BAGNO





ACCESSORI BAGNO

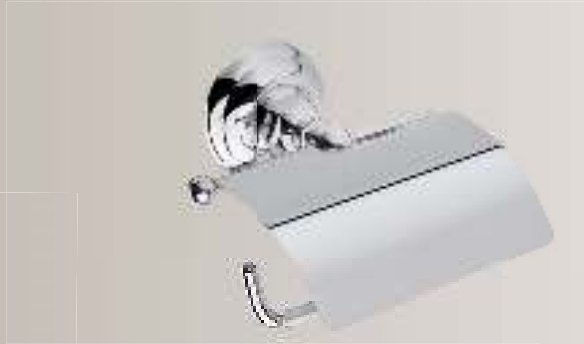
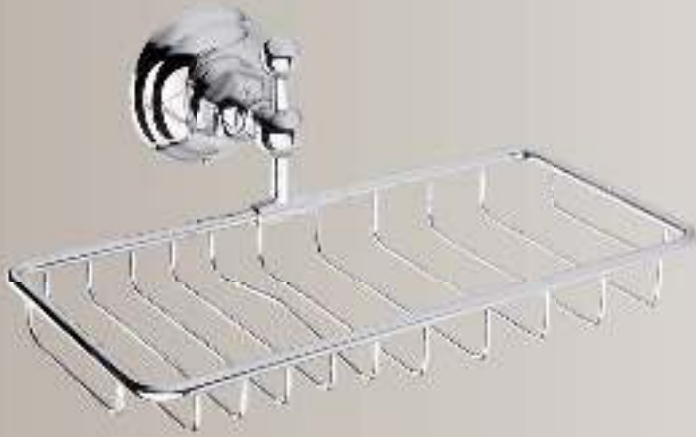



MADE WITH
SWAROVSKI
ELEMENTS



MADE WITH
SWAROVSKI
ELEMENTS



ACCESSORI BAGNO



accessori bagno



1480 Mensola cm. 60
Shelf cm. 60



1481 Appendiabiti
Clothes-hanger



1482 Portasalvietta a snodo
Jointed towel holder



1483 Portasalvietta cm. 30
Towel holder cm. 30

1484 Portasalvietta cm. 45
Towel holder cm. 45

1486 Portasalvietta cm. 60
Towel holder cm. 60



1485 Portasalvietta ad anello
Towel ring



1487D Portasapone
Soap holder



1488B Portabicchiere
Tumbler holder



1489D Dosasapone
Soap dispenser holder



1491B Portascopino
Toilet brush holder



1492 Portarotolo
Paper holder



1494 Portasapone e bicchiere
d'appoggio (senza ceramiche)
Soap and tumbler holder
(without ceramics)



1498 Portasalvietta doppio
Double towel holder



147934** Pomolo in cristallo
per cassetto
Crystal knob for drawer

MADE WITH
SWAROVSKI
ELEMENTS



MADE WITH
SWAROVSKI
ELEMENTS

MADE WITH
SWAROVSKI
ELEMENTS



****09**

Disponibile anche con finali
in pietre naturali
Also available with natural
stoners knobs



****34**

Disponibile anche con finali
in cristallo Swarovski
Also available with crystal
Swarovski knobs



****43**

Disponibile anche con finali
in cristallo Swarovski nero
Also available with black
crystal Swarovski knobs

■ TEIDE
collection



accessori d'appoggio "On shelf" *accessoris line*

CLASSICA collection

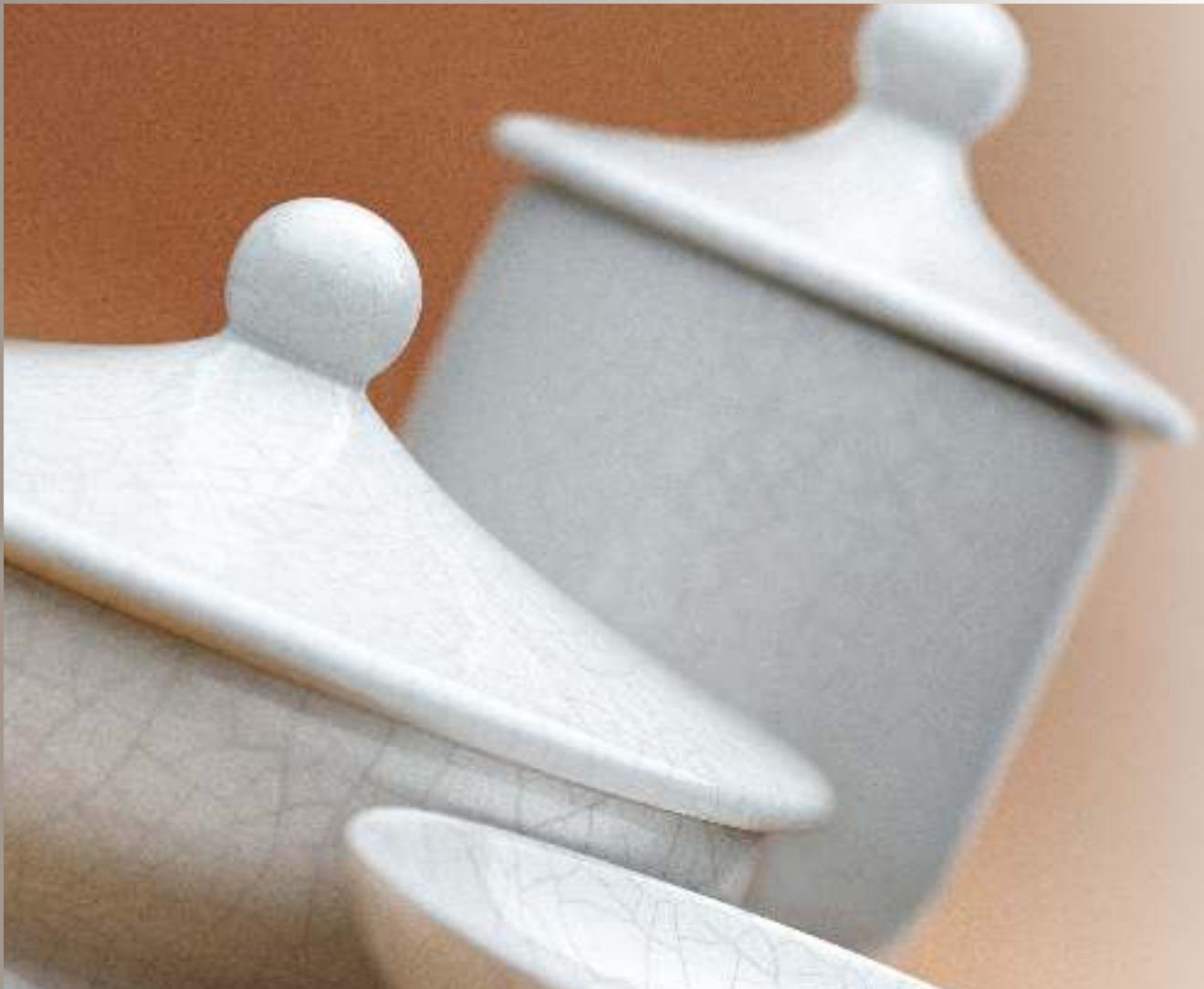

Esempio di ceramica anticata / *Exemple of antique ceramic version*



ACCESSORI BAGNO



accessori d'appoggio



6000 *Portasapone*
Soap holder



6001 *Portaspazzolino*
Toothbrush holder



6002 *Bicchiere*
Tumbler



6003 *Scatola*
Box



6004 *Barattolo*
Pot



6005 *Vassoio*
Tray



6006 *Dispenser*
Dispenser



■ GRAB BAR

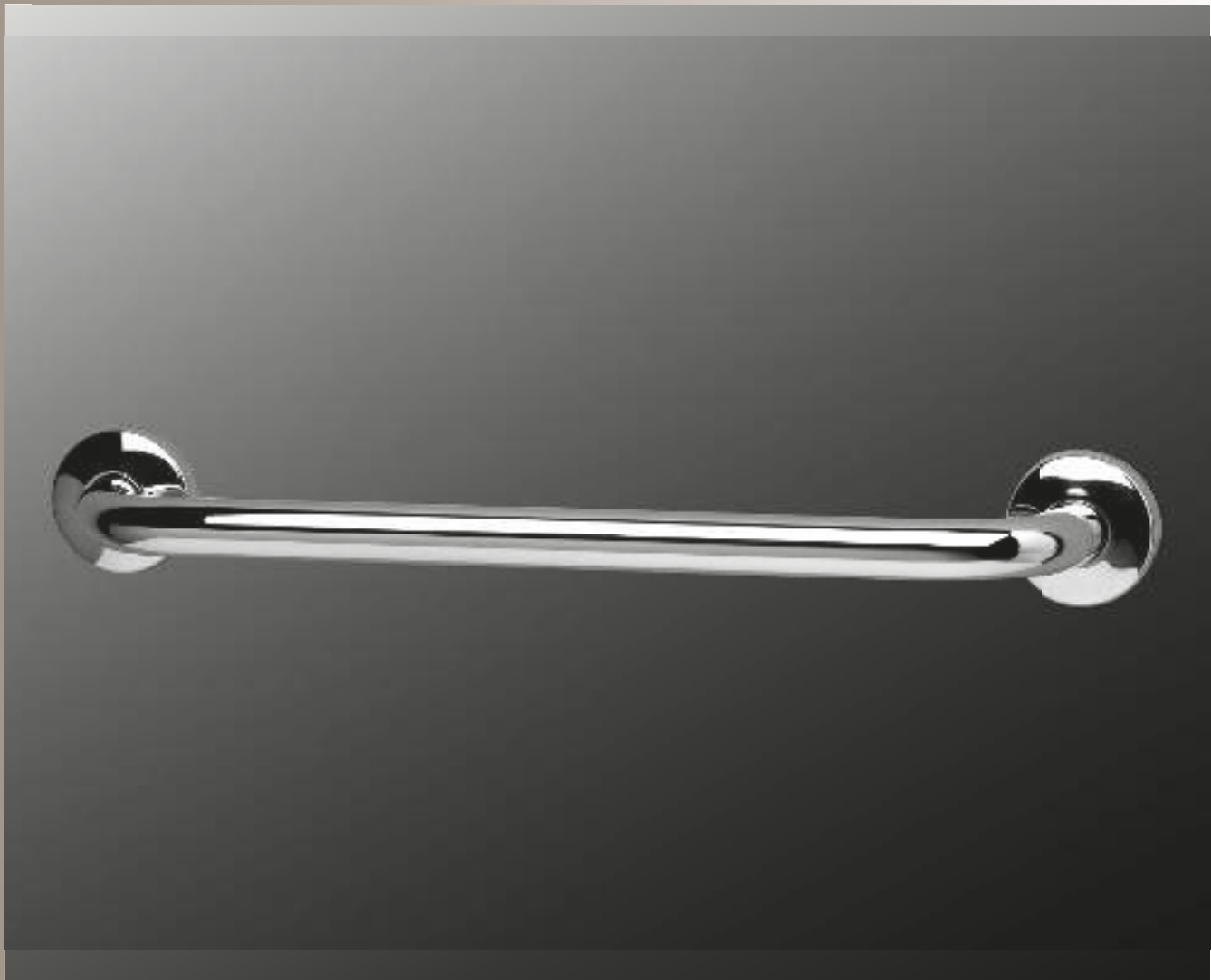

Nicolazzi

■ DOCCIA
collection



Nicolazzi



DOCCIA COLLECTION





DOCCIA COLLECTION





DOCCIA COLLECTION

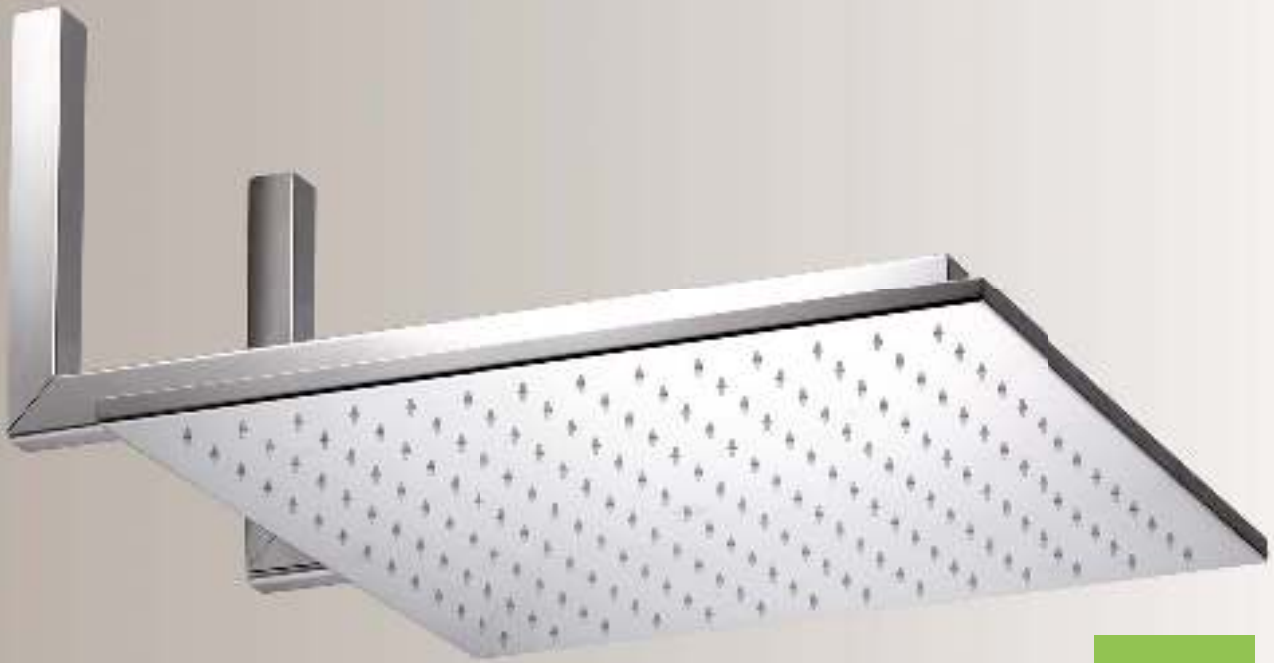

INOX
STAINLESS
STEEL





INOX
STAINLESS
STEEL



INOX
STAINLESS
STEEL

DOCCIA COLLECTION





DOCCIA COLLECTION



DOCCIA COLLECTION

Example for installation - Exemples pour installation - Beispiele für die Installation
 Ilustración de instalación - Exemplo de instalación - Примеры инсталляции

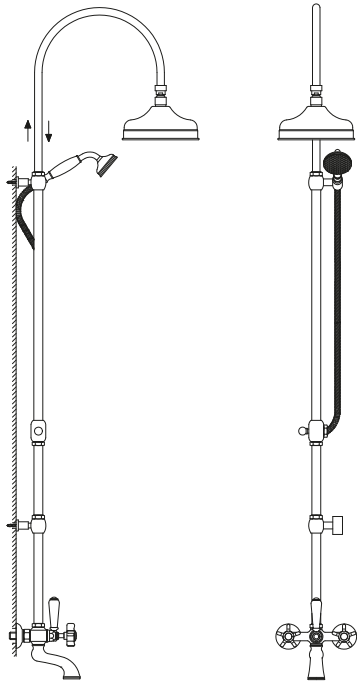

Art. 5712WS--20+5606EXT+1400

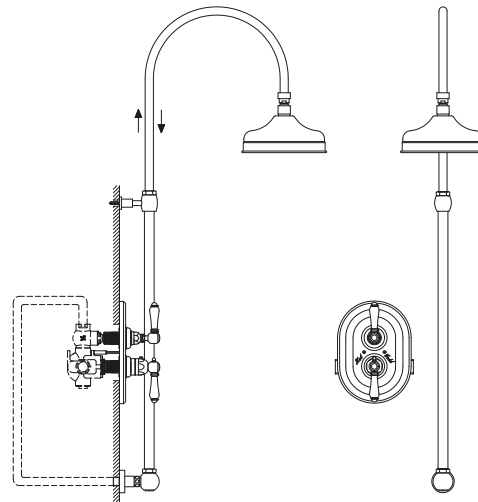

Art. 5712--20+5699A+4909--69+4910

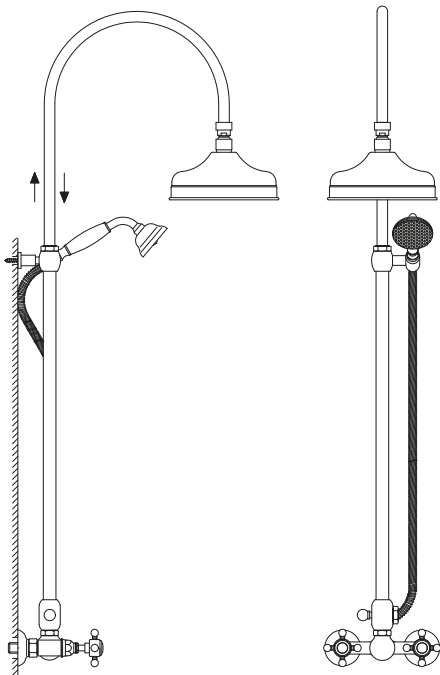

Art. 5712WS--20+1425--70

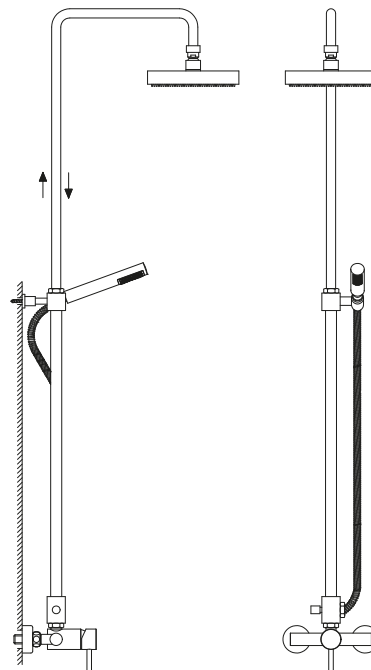

Art. 5714WS--20+3725

DOCCIA COLLECTION

Example for installation - Exemples pour installation - Beispiele für die Installation
 Ilustración de instalación - Exemplo de instalación - Примеры инсталляции

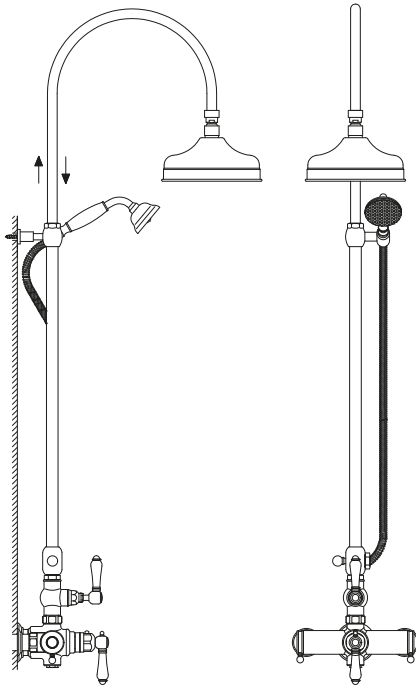

Art. 5712WS--20+4917--69

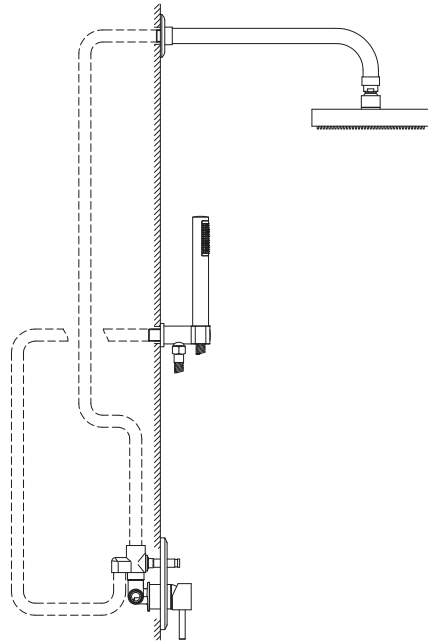

Art. 5704--20+3796+C7124M+C7135+C7097

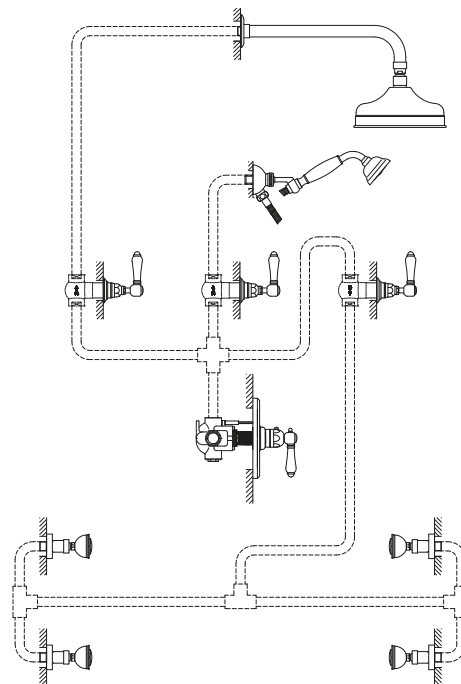

Art. 5702--20+4913+4914--69+4911
 +4912--69+C7124+C7104+C7097+5603

particolari

details

■ **SCARICHI**
Pop-up waste



■ **ARTICOLI VARI**
Various articles



■ **MANIGLIE E LEVE**
Handles and levers



Nicolazzi

condizioni di vendita

sales condition

VALIDITA' DEL CONTRATTO, QUOTAZIONI, CONSEGNA

Con il conferimento dell'ordine si intendono integralmente accettate le seguenti condizioni:

- Gli ordini trasmessi direttamente o tramite rappresentante costituiscono impegno per la ditta NICOLAZZI SpA solo dopo la conferma scritta.
- L'annullamento di un ordine non può essere ottenuto senza il consenso della ditta.
- I termini di consegna si intendono approssimativi e non impegnativi essendo essi vincolati alle disponibilità del momento, la mancata osservanza da parte nostra dei termini di consegna indicati non dà diritto al cliente di annullare l'ordine, differire i pagamenti o reclamare indennizzi, compensi, penali o danni di sorta.
- Salvo diverse intese o ritardi di consegna dovuti a causa di forza maggiore gli ordini cessano di validità 6 mesi dopo la conferma scritta.
- La merce viaggia a rischio e pericolo del destinatario anche quando la spedizione viene effettuata in porto franco, l'azienda declina ogni responsabilità per ritardi, guasti, avarie, rotture, danni, ammanchi causati direttamente o indirettamente dal vettore.
- Le quotazioni di questo catalogo/listino si intendono IVA esclusa e sono espressi in Euro; le quotazioni si intendono per merce resa franco stabilimento di Alzo.
- I prezzi del presente catalogo/listino sono calcolati sugli elementi di costo attuali; nel caso in cui questi dovessero variare saranno modificati in conformità i prezzi.
- La ditta si riserva inoltre il diritto di modificare tecnicamente ed esteticamente la propria produzione.

RECLAMI

- Eventuali reclami riguardanti la quantità o la qualità della merce consegnata debbono essere fatti entro otto giorni dal ricevimento della merce e sempre che la merce si trovi nelle stesse condizioni.
- I materiali ritenuti difettosi potranno essere restituiti solamente previa visione del ns agente ed autorizzazione della ditta. La spedizione dovrà essere effettuata in porto franco.
- La responsabilità della ditta si limita alla sostituzione dei pezzi difettosi e non indennizza eventuali danni diretti o indiretti causati dai nostri materiali.
- Si declina inoltre ogni responsabilità per errata installazione e/o manomissione dei nostri materiali.

PAGAMENTI

- Le modalità di pagamento specificate in fattura si intendono tassative: ogni cambiamento che non sia stato preventivamente ed espressamente pattuito non verrà accettato.
- In caso di ritardato pagamento verranno addebitati gli interessi di mora nella misura stabilita dall'art 5 del D.Leg 231/2002 che decorreranno dal giorno successivo alla scadenza.

RISERVA DI PROPRIETA'

- La merce consegnata rimane di riservato dominio della NICOLAZZI SpA fino all'avvenuto pagamento.

CONTESTAZIONI

- Per eventuali contestazioni è esclusivamente competente il foro di Verbania.

GARANZIA

- Tutti i nostri prodotti stati rigorosamente controllati e collaudati prima di essere posti in vendita e sono coperti da garanzia per un periodo di 6 anni dalla data di acquisto del primo acquirente.
- La garanzia decade qualora:
 1. sia fatto un uso improprio del prodotto
 2. il materiale sia stato modificato o manipolato da persona non autorizzata dalla NICOLAZZI SpA
 3. Il materiale sia stato montato in maniera non corretta
 4. il deterioramento della rubinetteria o dei suoi componenti sia dovuto alla qualità dell'acqua (es. calcare)
- Le superfici non sono coperte da garanzia in quanto subordinate alla cura dell'utente.

VALIDITY OF ORDERS (POS), PRICES, DELIVERY

In reference to your PO we consider accepted following conditions:

- Pos received directly or through agent are an engagement from NICOLAZZI SpA only after written confirmation.
- Pos can be cancelled only in agreement with NICOLAZZI SpA.
- The delivery times are approximate and not binding since they are bound by the availability of the moment. Our failure to observe the terms of delivery specified does not entitle the customer to cancel the order, defer payments or claim any compensation, fees, penalties or damage of any kind.
- If it is not differently indicated orders lose their validity 6 months after confirmation.
- The goods travel at the risk of the recipient when the shipment is prepaid, the company accepts no responsibility for delays, failures, breakdowns, breakages, damage, shortages caused directly or indirectly by the carrier.
- The prices in this catalog / price list are exclusive of VAT and are expressed in Euro; Prices indicated in this documentation are intended Ex work Alzo - EXW.
- Prices in this catalog / price list are calculated on the elements of the current costs; in case these should differ will be amended in accordance with the prices.
- NICOLAZZI SpA has the right to change products in order to improve them technically and aesthetically.

COMPLAIN

- Claims are accepted within 8 days from receiving the goods.
- Returns are accepted only after control of our Area Managers or agents and Company authorization. Return shipment will be done in DDP terms – Delivery Duty Paid - (Carriage Paid).
- Company will replace defective components without refunding direct and in direct damages caused by our goods.
- NICOLAZZI SpA is not responsible for improper installations or non authorized modifications of its goods.

PAYMENTS

- The terms of payment specified in the bill are mandatory. Every change that has not been previously and expressly agreed upon will not be accepted.
- In case of delayed payment will be charged default interest in the amount established by Article 5 of the D.Leg 231/2002 which will begin the day after the deadline.

PROPERTY

- Goods are of NICOLAZZI SpA's property until payment has been settled.

LEGAL ISSUES

- In case of legal needs it is competent "Foro di Verbania".

WARRANTY

- All our products have been rigorously checked and tested before being offered for sale and are warranted for a period of 6 years from the date of the first customer purchase.
- The warranty is void if:
 1. has made improper use of the product
 2. the material has been altered or manipulated by an unauthorized person from NICOLAZZI SpA
 3. the material has been assembled incorrectly
 4. the deterioration of the fitting or its components is due to water quality (eg. limestone).
- The surfaces are not covered by warranty as subject to the care and use of the user.

vitoni
 valves
 cartouches
 oberteil
 cabezas
 cabeça
 Винт

VITONE A DISCHI CERAMICI
 CERAMIC CARTRIDGE
 CARTOUCHE CERAMIQUE
 OBERTEIL MIT KERAMIKSCHEIBE
 CABEZA CON DISCOS CERÁMICOS
 CABAÇA DISCOS CERÁMICOS
 ГОЛОВКА ВЕНТИЛЯ С
 КЕРАМИЧЕСКИМИ ДИСКАМИ

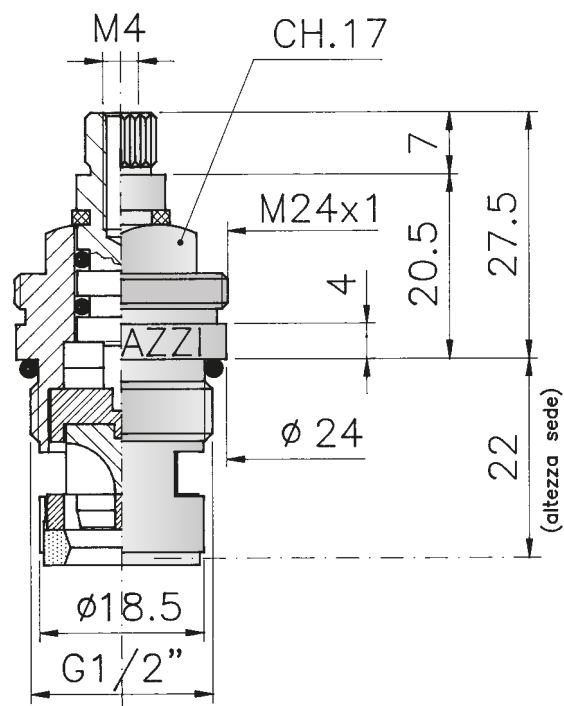

I «vitoni» tradizionali e a dischi ceramici sono intercambiabili tra loro con tutte le serie di rubinetti NICOLAZZI.

The "valves", traditional or ceramic discs, are interchangeable, between them, for all the series of NICOLAZZI taps.

Les "cartouches" traditionnelles ou ceramiques sont interchangeables, entre eux pour toutes les series de la robinetterie NICOLAZZI.

Die traditionellen «Oberteile» und mit Keramikscheibe sind untereinander austauschbar mit der gesamten Armaturensere NICOLAZZI.

Las «cabezas» tradicionales y con discos cerámicos son intercambiables entre ellas con todas las serie de grifos NICOLAZZI.

As cabeças tradicionais e com discos cerámicos são intercambiáveis entre si com todas as séries de torneiras NICOLAZZI.

Прижимные винты и керамические диски взаимозаменяемы во всех сериях смесителей NICOLAZZI



cartuccia

cartridge
cartouche
kartusche
cartucho
Катридж

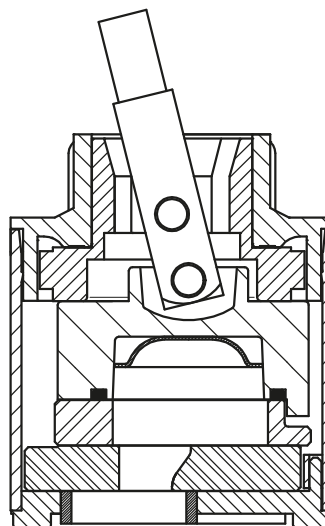

ART. 3009

La "cartuccia" è intercambiabile con tutti i monocomandi prodotti dalla NICOLAZZI, sin dal primo modello, (tranne la serie Pumori, Cho Oyu, Olympus, Antelao, Cinquanta, Vincent, Jungfrau, Diamir 2). La "cartuccia" dalla sua prima versione ha subito diverse modifiche che ne hanno migliorato la qualità pur mantenendo l'intercambiabilità.

The "cartridge" is interchangeable for all the single-lever taps produced by NICOLAZZI, since the first model created (except Pumori, Cho Oyu, Olympus, Antelao Cinquanta, Vincent, Jungfrau, Diamir 2). The "cartridge", from its first version, has been modified several times, this has permitted to improve the quality, always maintaining the interchangeability.

La "cartouche" est interchangeable pour toutes les séries de mélangeurs monoleviers produits de NICOLAZZI à partir du premier modèle réalisé (excepté série Pumori, Cho Oyu, Olympus, Antelao, Cinquanta, Vincent, Jungfrau, Diamir 2). La "cartouche", après la première version, a été modifié plusieurs fois, ce la pour améliorer la qualité toujours gardant l'interchangeabilité.

Die "Kartusche" ist vom ersten Modell an mit allen Einhebelbatterien austauschbar, die von NICOLAZZI hergestellt sind (except Pumori, Cho Oyu, Olympus, Antelao, Cinquanta, Vincent, Jungfrau, Diamir 2 series). An der ersten "Kartusche" sind mehrmals Abänderungen durchgeführt worden, die ihre Qualität verbessert haben, wobei sie jedoch austauschbar bleibt.

El "cartucho" es intercambiabile con todos los monomandos producidos por NICOLAZZI, a partir del primer modelo (excepto para colección Pumori, Cho Oyu, Olympus, Antelao, Cinquanta, Vincent, Jungfrau, Diamir 2). El "cartucho", desde su primera versión, se ha modificado varias veces, mejorando su calidad y, sin embargo, manteniendo su intercambiabilidad.

O cartucho è intercambiável com todos os monocomandos da NICOLAZZI, desde o primeiro modelo (com a exceção da série Pumori, Cho Oyu, Olympus, Antelao, Cinquanta, Vincent, Jungfrau, Diamir 2). O cartucho da sua primeira versão teve diversas modificações que melhoraram a qualidade mesmo mantendo a intercambiabilidade.

"Катридж" взаимозаменяем во всех однорычажных смесителях NICOLAZZI, начиная с первой модели (за исключением серии Pumori, Cho Oyu, Olympus, Antelao Cinquanta, Vincent, Jungfrau, Diamir 2).

"Катридж" сразу имеет изменения, которые улучшили качество сохраняя взаимозаменяемость



esempi finiture

finishings example



CR



CB



CS



FV



NL



NS



GF



GB

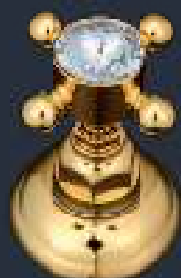

GO



AG



BZ



RA



TB



OG



OL



Rubinetteria **NICOLAZZI** S.p.A.
28010 ALZO (Novara) ITALY - Via P.Durio, 119
Tel. +39 0322 96.96.72 r.a.
Fax +39 0322 96.95.32 r.a.
info@nicolazzi.it

Azienda aderente



www.nicolazzi.it

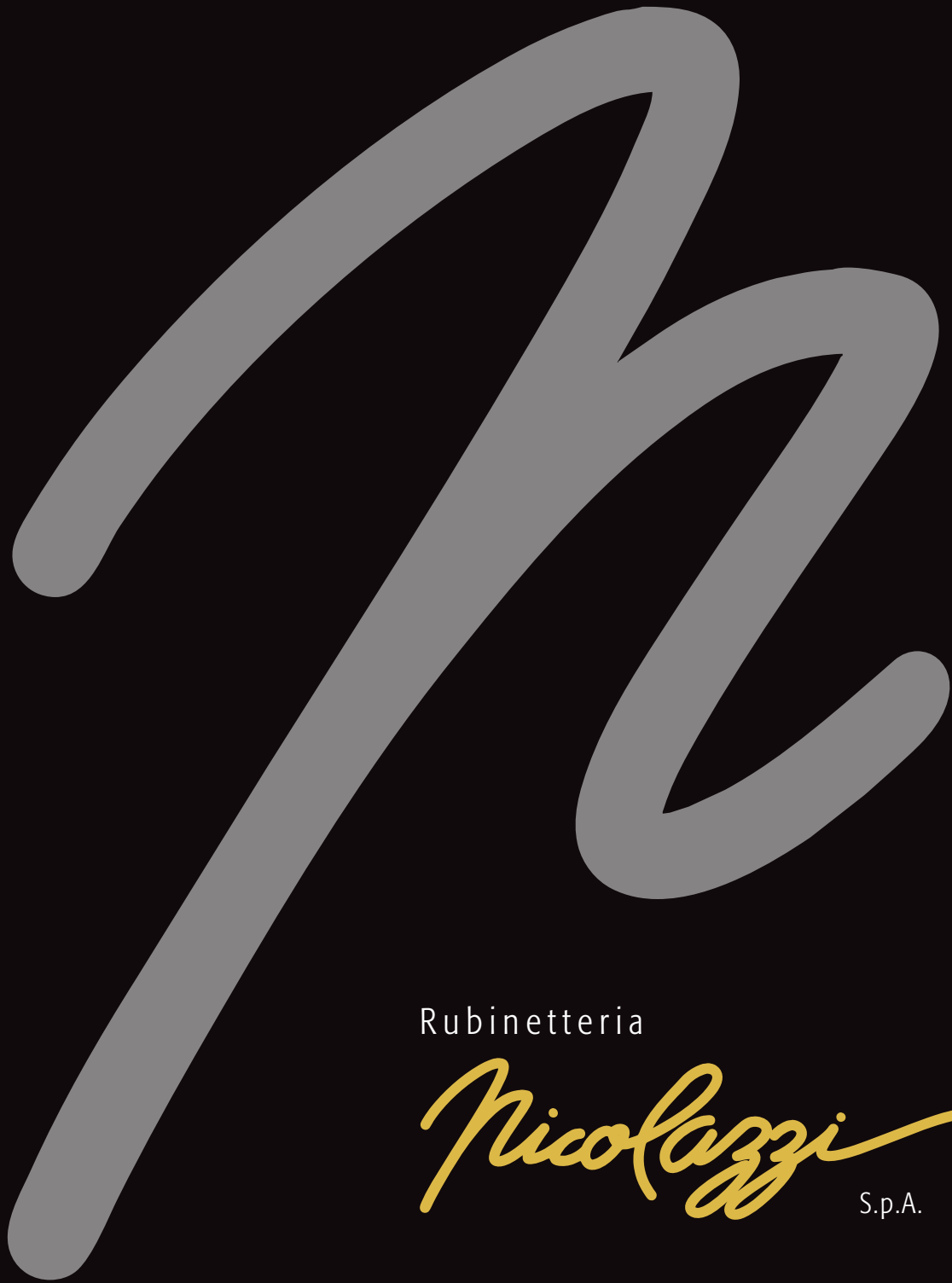

Rubinetteria

Nicolazzi

S.p.A.

CATALOGO LISTINO PREZZI NOVITÀ
integrazione listino prezzi 2014

Catalogue price list
Catalogue tarif des prix
Katalog und Preisliste
Catálogo y lista de precios
Catálogo y lista de preços
Каталог прайс лист

www.nicolazzi.it

Ecologico

CONSUMO D'ACQUA RIDOTTO DEL 50%
WATER SAVING 50%

Ecologico

PRODOTTO SENZA PIOMBO E NICHEL
CON OTTONE IN LEGA ANTIDEZINCIFICANTE
LEAD AND NICKEL FREE
BRASS ALLOY WITHOUT ZINC

La tradizione del Made in Italy di Alta Qualità nel rispetto della salute del consumatore e dell'ambiente *The tradition of High Quality Made in Italy in the environment and health respect*

L'acqua è un bene sempre più scarso e per questo sempre più prezioso. Più di un miliardo di persone nel mondo non hanno accesso all'acqua potabile ed almeno 500 milioni soffrono di grave carenza d'acqua. Non avere accesso all'acqua significa non avere a disposizione la quantità d'acqua minima giornaliera per le funzioni vitali. Il fabbisogno minimo biologico per la sopravvivenza è infatti di 5 litri in 24 ore, ma per parlare di condizioni accettabili c'è bisogno di un minimo giornaliero di circa 50 litri d'acqua pro capite. La crescita demografica della popolazione mondiale, l'aumento del consumo d'acqua nei paesi più ricchi e l'inquinamento delle risorse idriche stanno, infatti, creando uno squilibrio tra la disponibilità e la richiesta d'acqua potabile generando una vera e propria emergenza destinata ad accentuarsi nei prossimi anni.

Nicolazzi S.p.A., a riconferma della continua attenzione rivolta alla difesa dell'ambiente ed all'ecologia, ha introdotto su tutta la rubinetteria da lavabo e da lavello uno speciale sistema di risparmio idrico al fine di ridurre del 50% il consumo d'acqua giornaliero (portata limitata a max. 5,7 L/min.). L'utilizzo di uno speciale rompigetto ad elevata aerazione garantisce inoltre la qualità del flusso di erogazione in ogni condizione di pressione.

L'acqua è un elemento fondamentale per la vita del nostro pianeta, una risorsa che deve essere protetta e preservata. Nicolazzi S.p.A. ci ha pensato, pensateci anche voi e richiedeteci i rubinetti con la riduzione di portata del 50% al fine di poter consumare anche voi solo l'acqua necessaria. Il risparmio d'acqua è un dovere civile nei confronti dei nostri simili, protegge l'ambiente (contribuisce anche alla riduzione delle emissioni di CO₂) e permette anche di risparmiare denaro.

Water is a more and more precious good because less and less available. More than a billion people in the world do not have access to drinkable water and 500 millions people have serious problems in getting water. Not having access to water means not having the minimum daily vital amount of water. Individual biological minimum need is 5 litres/24hours, but in order to have acceptable conditions we speak about 50 litres/24hours. World population increase, huge use of water in western Countries and pollution of available sources are causing a general water emergency, estimated to get worse in years to come.

Nicolazzi S.p.A., confirming once more its attention to environment, applied to all washbasins and sink mixers a "water saving system" in order to reduce by 50% the daily use of water (max 5,7 l/min.). Use of a special aerator with high air amount gives a good water flow with low pressure as well.

Water is a basic element for life on our planet, a resource to be protected and saved. Nicolazzi S.p.A. cares about it, you can do the same by requiring "50% water saving" taps in order to use only the water you need. "Water saving" is a positive attitude, it protects the environment (it helps reducing carbon dioxide emissions, CO₂) and it helps you saving money.

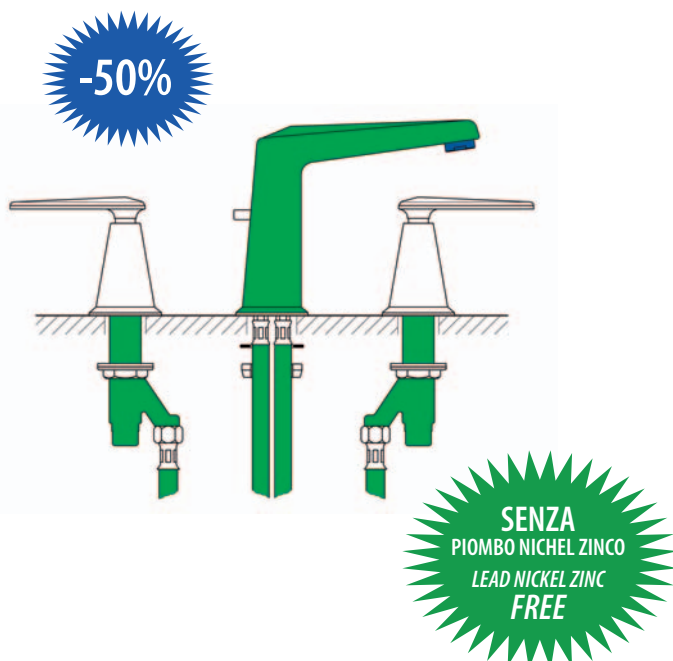

Nicolazzi S.p.A., da anni attenta ai problemi derivanti dal possibile rilascio di sostanze inquinanti e tossiche dei rubinetti, si è attivata per realizzare prodotti atossici soprattutto per quanto riguarda la cessione di metalli pesanti quali PIOMBO e NICHEL. La rubinetteria Nicolazzi S.p.A. sulla base di strette normative internazionali ha applicato all'intera produzione, che interessa la rubinetteria da cucina e da lavabo, un nuovo speciale ciclo produttivo che elimina la cessione di questi metalli pesanti già all'origine. A tale proposito, Nicolazzi S.p.A. si è attivata per sostituire il trattamento chimico da anni impiegato per la rimozione del PIOMBO dai rubinetti, con l'utilizzo di ottoni SENZA PIOMBO di nuova generazione (Pb max. 0.25%) nella propria produzione ecologica. Tale scelta, pur essendo antieconomica per l'azienda, risulta essere un'ulteriore riconferma della filosofia aziendale rivolta a garantire la salute del consumatore soddisfacendo al tempo stesso la legge americana Ab1953, che ad oggi risulta essere la più restrittiva in materia. Tutto questo, abbinato all'impiego di un sistema chimico che inibisce la cessione di NICHEL a contatto con l'acqua potabile ed all'utilizzo di guarnizioni e/o prodotti non metallici atossici, ha permesso a Nicolazzi S.p.A. di testare i propri rubinetti anche secondo la norma americana NSF-61, con una cessione in acqua potabile di PIOMBO inferiore a 11 ppb (µg/l) e di NICHEL inferiore a 20 ppb (µg/l).

N.B: Le limitazioni attualmente più rappresentative per la cessione di metalli da parte di articoli di rubinetteria nelle acque potabili limitano appunto la cessione del PIOMBO a 11 ppb (µg/l) e la cessione di NICHEL a 20 ppb (µg/l).

Oltre a certificare che tutti i rubinetti per cucina e lavabo subiscono questo speciale ciclo produttivo ANTI-PIOMBO e NICHEL, i pezzi sono prodotti con ottone in lega ADZ antidezincificante (assenza rilascio di ZINCO), nel rispetto della norma Australiana Watermark e trattati secondo le norme americane NSF-61.

Nicolazzi S.p.A., prima in Italia ad adottare questo procedimento, dimostra in questo modo un'alta sensibilità ai problemi connessi all'ambiente, all'ecologia ed alla salute del consumatore.

La riconoscibilità del prodotto è garantita dal marchio "Ecologico" su ciascun rubinetto.

Nicolazzi S.p.A., very careful with issues concerning release of toxic materials from water taps, has been manufacturing for many years "health friendly" products, mainly not releasing heavy metals such as LEAD and NIKEL into drinking water.

Nicolazzi S.p.A., based on strict international rules, is using a special manufacturing system for all its sinks and washbasin taps to avoid release of heavy metals. To this regard, Nicolazzi S.p.A. has now started a re-organizing process to replace previous "LEAD washing" chemical treatment with the use of new generation LEAD-FREE brass (maximum LEAD 0.25%). This costly Company policy confirms the philosophy to grant consumers' health in respect of the new American norm Ab1953, actually the strictest one in our business. All this, with the chemical treatment to avoid release of NIKEL in drinking water and the use of non-toxic washers and components, allowed Nicolazzi S.p.A. to obtain American norm NSF-61, with a LEAD release less than 11 ppb (µg/l) and NIKEL less than 20 ppb (µg/l).

NOTE: Actually the strictest limitation for heavy metals release in drinking water for taps are LEAD less than 11 ppb (µg/l) and NIKEL less than 20 ppb (µg/l).

Beside above procedures against LEAD and NIKEL, our items are made with a special DZR brass (alloy with no release of ZINC) for the Australian Watermark regulation and produced following the NSF-61 American rules.

Nicolazzi S.p.A., the first Italian Company with this manufacturing process, shows a strong sensibility to problems regarding environment, ecology and consumers' health.

Our commitment is granted by the "ECOLOGICO" logo on each tap.

Esempi di Cessione di Nichel e Piombo da rubinetti Nicolazzi prodotti con il processo "ECOLOGICO" e rubinetti non trattati.

Examples of session of nickel and lead from Nicolazzi's taps made with "ECOLOGICO" process, and taps not treated.

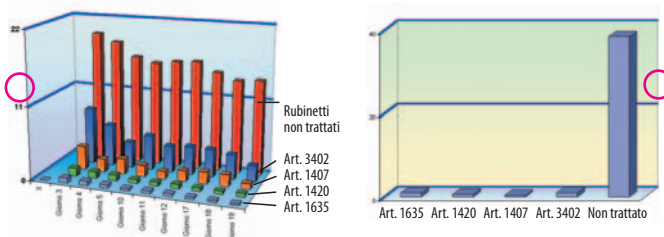

Limite massimo accettabile 11 ppb di piombo.
The acceptable maximum limit is 11 ppb of lead.

Limite massimo accettabile 20 ppb di nichel.
The acceptable maximum limit is 20 ppb of nickel.

rubinetteria
NICOLAZZI



Dal 1960, anno della sua fondazione, la NICOLAZZI S.p.A. ha la sede in Alzo (No), piccolo paese sul lago d'Orta famoso in tutto il mondo per la lavorazione del granito prima (fino agli anni '50) e dei rubinetti oggi.

La Rubinetteria NICOLAZZI si è innestata in questa tradizione operando ad alto livello tecnologico che, insieme alla ricerca stilistica e funzionale, permette la realizzazione di una rubinetteria di qualità superiore.

La ditta NICOLAZZI studia e progetta i suoi prodotti in modo autonomo ed originale nel rispetto delle normative internazionali. Sottopone ogni pezzo ad un serio e minuzioso collaudo controllando tenuta, rumorosità, durata, funzionalità ed accurate finiture.

Questo modo di produrre ha permesso di adottare il sistema di qualità ISO 9000. La certificazione è un'ulteriore garanzia della qualità del prodotto che esce dal proprio stabilimento per raggiungere i clienti più esigenti alla ricerca di prodotti qualificati. Una efficiente rete commerciale assicura una distribuzione dei nostri prodotti sia in Italia che nel mondo.

"From 1960, the year of this establishment, the NICOLAZZI S.p.A. is placed in Alzo (No) a small village on the lake of Orta, famous all over the world for the granite-working until the Fifties and nowadays for the production of taps."

The NICOLAZZI tap manufacturer has married this tradition working with an high technical standard, that, together with stylistic and functional research, allows the realisation of superior quality taps.

The company NICOLAZZI studies and designs its own items in an original and individual way, by respecting the International Norms. Each piece is subject to a very serious and particular inspection by testing water-seal, noise, corrosion, functionality and careful finishings.

This way of production allowed to adopt the quality system ISO 9000. The certification is a further guarantee of the quality of our items, that leave the factory to reach the most exigent clients that are looking for qualified products.

A very efficient commercial organisation assure the distribution of our articles in Italy and in the world."



certificazione prodotti
products certification

USA - CANADA *



USA *

LOW-LEAD

California
Lead Plumbing Law
AB 1953

USA *

GREEN



AUSTRALIA and
NEW ZEALAND *



AUSTRALIA and
NEW ZEALAND *



BELGIUM *



BELGAQUA

RUSSIA *



* For selected items only

certificazione
certification



SISTEMA QUALITA'
CERTIFICATO UNI
EN ISO 9001:2008

Certificato n° 0316

tabella finiture finishings table

- CR** CROMO / *CHROME*
- NL** NICHEL LUCIDO / *BRIGHT NICKEL*
- OG** OTTONE GREZZO / *RAW BRASS*
Ottone naturale soggetto ad ossidazione / *Living natural brass*
- OL** OTTONE LUCIDO / *SHINING BRASS*
Ottone naturale soggetto ad ossidazione / *Living natural brass*
- OS** OTTONE SPAZZOLATO / *BRUSHED BRASS*
Ottone naturale soggetto ad ossidazione / *Living natural brass*
- GO** ORO / *GOLD*
- RG** ORO ROSA / *ROSE GOLD*

finiture speciali special finishings

- AG** ANTIQUE GOLD / *ANTIQUE GOLD*
- BZ** BRONZATO / *BRONZE PLATED*
- CB** CROMO SPAZZOLATO / *BRUSHED CHROME*
- CO** CROMO ORO / *CHROME GOLD*
- CS** CROMO SATINATO / *SATIN CHROME*
- FV** FERRO VECCHIO / *IRON*
- GB** GOLD BRASS / *GOLD BRASS*
- GF** ORO INGLESE / *ENGLISH GOLD*
- NS** NICHEL SATINATO / *SATIN NICKEL*
- RA** RAMATO / *COPPER PLATED*
- TB** TUSCAN BRASS / *TUSCAN BRASS*
Ottone naturale soggetto ad ossidazione / *Living natural brass*
- CL** COLORATO / *COLOURED*
- DB** BRONZO SCURO / *DARK BRONZE*
- DBM** BRONZO SCURO OPACO / *DARK BRONZE MATT*

ISTRUZIONI PER LA PULIZIA CLEANING INSTRUCTIONS

La pulizia di tutti i nostri prodotti deve essere eseguita esclusivamente utilizzando acqua, sapone neutro ed un panno morbido (NON abrasivo) al fine di preservarne la finitura nel tempo. Tutti i prodotti devono sempre essere asciugati con un panno morbido (NON abrasivo) al fine di impedire la formazione di depositi di calcare. Per quanto riguarda la finitura TB suggeriamo l'utilizzo della nostra speciale cera (articolo C9996) al fine di mantenere nel tempo il tipico colore "marrone". Le finiture non sono coperte da garanzia in quanto subordinate alla cura dell'utente.

Concerning cleaning of our products we suggest you to use always water, neutral soap and a soft cloth. This will allow you to preserve finishings for a long time. For TB we have a special wax (item C9996) to maintain longer its typical «brown» colour. Finishings are not covered by warranty.

guida alla composizione del codice di acquisto instructions to compose the purchase code

La composizione del codice d'acquisto deve essere eseguita nel seguente modo:
The composition of the purchase code must be effected in the following way:

esempio / for example

Art. **2002 CR 38**

- Tipo di maniglia / Type of handle
- Sigla finitura / Finishing abbreviaton
- Codice articolo / Code article

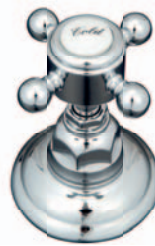

CR

Classica finitura galvanica di cromo lucido realizzata a spessore al fine di garantire lunga durata. L'elevata durezza superficiale tipica del cromo conferisce ai prodotti elevate doti di resistenza.

Standard chrome finishing worked in «thick layer» to give long durability and strong resistance.



FV

Finitura galvanica di tonalità scura, sottoposta a lavorazione manuale di "spazzolatura" e protetta da vernice trasparente opaca.

Dark galvanic finishing, hand brushed and protected with a matt transparent paint. Good for modern and antique styles.



GF

Finitura galvanica di doratura realizzata a spessore con i medesimi materiali impiegati per il gold brass però con concentrazione ridotta al fine di fornire un oro di tonalità ancora più chiara tipica dei paesi anglosassoni.

Galvanic gold colour. Second shade of gold colour.



AG

Finitura galvanica con tonalità simile all'oro antico, sottoposta a lavorazione manuale di "spazzolatura" e protetta da vernice trasparente opaca. Indicata per le serie classiche.

Galvanic gold colour, hand brushed and protected with a matt transparent paint. Indicated for classic style.



TB

Finitura di esclusiva Nicolazzi che conferisce un vero look antico ai prodotti tramite ossidazione dell'ottone. **IMPORTANTE:** questa è una finitura "viva" (non protetta) che cambia nel tempo offrendo variazioni di colore tipiche dell'ossidazione dell'ottone in abbinamento al tipico colore giallo del metallo che riemerge nelle zone di maggior contatto durante l'uso (maniglie, canne, etc.). **NON PULIRE CON PRODOTTI AGGRESSIVI.**

Exclusive finishing from Nicolazzi. Real antique look. Galvanic oxidation of brass. IMPORTANT to know it is a «Living Finishing», it changes in time. A brass colour will come out. DO NOT CLEAN WITH AGGRESSIVE PRODUCTS.

**Ottone naturale soggetto ad ossidazione
Living natural brass**



CL

Classica finitura colorata (nera o bianca) ottenuta tramite verniciatura polimerica e successivamente cotta al forno per garantirne la più alta resistenza.

Classic coloured (black or white) finish obtained by «polymer coating» and then baked in the oven to ensure the highest resistance.



Finitura con le medesime caratteristiche del cromo con l'aggiunta della lavorazione manuale di "spazzolatura". Ottima sia per le serie moderne che per le serie classiche.

Like CR but hand brushed. Good for modern and antique styles.

CB



Finitura con medesime caratteristiche del cromo realizzata su superficie satinata anziché lucida. Normalmente viene utilizzata nelle serie moderne ed è eccellente, vista la sua resistenza, per la linea cucina.

Chrome finishing on a «rough» surface. Normally used on modern styles and excellent for kitchen faucets for its strength.

CS



Tipica finitura galvanica di nichel lucido. Eccellente per le serie classiche. **IMPORTANTE:** Nicolazzi offre questa finitura allo stesso prezzo del cromo. Rivestimento di base per la finitura oro, pur essendo realizzata a spessore, mantiene le caratteristiche tipiche del metallo nichel (morbidezza e predisposizione a lievi variazioni di tono nel tempo).

Typical galvanic polished nickel finishing. Excellent for antique style. IMPORTANT is Nicolazzi offers it at same price than Chrome. First shade of gold colour.

NL



Finitura con le medesime caratteristiche del Nichel con l'aggiunta della lavorazione manuale di "spazzolatura". Normalmente chiamata "color acciaio" è eccellente sia per le serie moderne che per le serie classiche.

Just like Nickel but hand brushed. Normally called «STEEL colour». Excellent for modern and classic styles.

NS

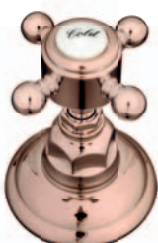

Rivestimento di vero oro 24k a spessore, ottenuto tramite processo galvanico che utilizza il sale industriale $KAu(CN)_2$ estratto direttamente dal metallo prezioso, con l'aggiunta di un additivo per ottenere una colorazione rosa.

Real 24k gold, obtained with the use in galvanic basin of an industrial salt $KAu(CN)_2$ extracted from Genuine Gold Metal with the addition of a «special additive» to obtain the pink colour.

RG



Rivestimento di vero oro 24k a spessore, ottenuto tramite processo galvanico che utilizza il sale industriale $KAu(CN)_2$ estratto direttamente dal metallo prezioso.

Real 24k gold, obtained with the use in galvanic basin of an industrial salt $KAu(CN)_2$ extracted from Genuine Gold Metal. Darkest shade of gold colour.

GO



Finitura galvanica di doratura realizzata a spessore con i medesimi materiali impiegati per l'oro però con concentrazione ridotta al fine di fornire un oro di tonalità più chiara.

Galvanic gold colour. Third shade of gold colour.

GB



Tipica finitura rame eseguita galvanicamente, sottoposta a lavorazione manuale di "spazzolatura" e protetta da vernice trasparente lucida.

Typical Copper galvanic finishing, hand brushed and covered with a brilliant transparent paint.

RA



Finitura di esclusiva Nicolazzi che conferisce un vero look antico ai prodotti. **IMPORTANTE:** questa è una finitura "viva" (non protetta) in quanto trattasi di ottone grezzo naturale non protetto che cambia nel tempo offrendo tonalità scure tipiche della passivazione del metallo.

Exclusive finishing from Nicolazzi. Real antique look. IMPORTANT to know it is a «Living Finishing» that changes in time. It is raw not protected brass, it will soon be darker.

Ottone naturale soggetto ad ossidazione
Living natural brass

OG



Finitura tipica dell'ottone sottoposto a lavorazione di lucidatura brillante. **IMPORTANTE:** questa è una finitura "viva" (non protetta) in quanto trattasi di ottone lucido naturale non protetto che cambia nel tempo offrendo tonalità scure tipiche della passivazione del metallo.

Polished brass NOT protected. IMPORTANT to know it is a «Living Finishing» that changes in time. It is not protected brass, it will soon be darker.

Ottone naturale soggetto ad ossidazione
Living natural brass

OL



Finitura ottenuta con la lavorazione manuale di "spazzolatura" sull'ottone naturale, **IMPORTANTE:** questa è una finitura "viva" (non protetta) in quanto trattasi di ottone grezzo naturale non protetto che cambia nel tempo offrendo tonalità scure tipiche della passivazione del metallo.

Raw brass hand brushed. IMPORTANT to know it is a «Living Finishing» that changes in time. It is not protected brass, it will soon be darker.

Ottone naturale soggetto ad ossidazione
Living natural brass

OS



Tipica finitura galvanica di bronzatura, sottoposta a lavorazione manuale di "spazzolatura" e protetta da vernice trasparente lucida.

Typical Bronze galvanic finishing, hand brushed and covered with a brilliant transparent paint.

BZ



Tipica finitura galvanica di bronzatura in versione scura, sottoposta a lavorazione manuale di «spazzolatura» e protetta da vernice trasparente lucida.

Typical Bronze galvanic finishing in dark version, hand brushed and covered with a brilliant transparent paint.

DB



Tipica finitura galvanica di bronzatura in versione scura, sottoposta a lavorazione manuale di «spazzolatura» e protetta da vernice trasparente opaca.

Typical Bronze galvanic finishing in dark version, hand brushed and covered with a matte paint.

DBM

index indice

■ EXTRA LUSO

LIBERTY Pag. 7

■ TRADIZIONALE

ARENA Pag. 15

AGORÀ Pag. 23

■ MONOCOMANDI

TORRE Pag. 33

ARENA Pag. 37

■ PROGRAMMA CUCINA

KITCHEN PULL-DOWN Pag. 44

KITCHEN Pag. 45

■ TERMOSTATICO Pag. 47

■ ACCESSORI BAGNO

LIBERTY Pag. 55

ARENA Pag. 63

AGORÀ Pag. 71

MONTE CROCE Pag. 77

■ ARTICOLI VARI - COMPLEMENTI Pag. 85

■ LIBERTY



NL - Nichel Lucido / Bright Nickel

Ecologico
PRODOTTO SENZA PIOMBO E NICKEL
CON OTTONE IN LEGA ANTIDIZINCIFICANTE
LEAD AND NICKEL FREE
BRASS ALLOY WITHOUT ZINC

Nicolazzi



LIBERTY

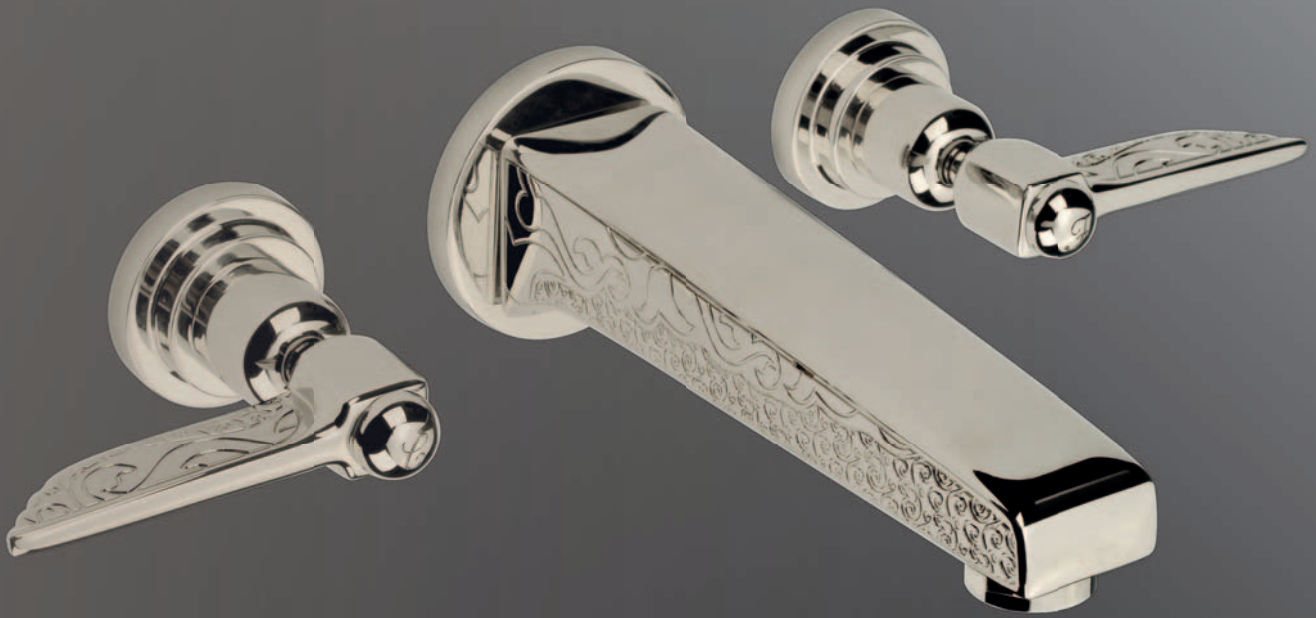

Liberty



1002 Gruppo vasca con doccia esterno duplex
Bath tub set with duplex shower



1008 Batteria lavabo scarico automatico
Wash basin mixer with automatic pop-up waste



1077 Batteria lavabo a parete
Wash basin wall mounted

LIBERTY

Con vitone ceramico / With ceramic cartridge / Avec cartouche ceramique / Mit oberteil aus keramik / Con cabeza ceramica / Com cabeça ceramica

Art. 1002

Gruppo vasca con doccia esterno duplex

Bathtub set with duplex shower
 Mélangeur bain avec douche duplex
 Aufputz-Badewannengruppe mit duplex Handbrause

Mezclador exterior para baño-ducha
 Misturadora de banheira c/flexivel
 Двухвентильный настенный с душем duplex для ванны

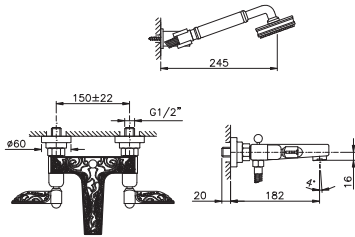

Optional Art. 5573 pag. 91

Finitura / Finishing

16

CR NL OG OL OS 682,00

FINITURE SPECIALI *
SPECIAL FINISHING 921,00

GO RG 1.085,00

Art. 1003

Gruppo vasca incasso erogazione a parete

Bathtub set wall mtg. central "sail" spout
 Mélangeur bain à encastrer
 Unterputz-Badewannengruppe mit Wandauslauf

Mezclador empotrado erogación de pared
 Grupo de banheira de encastrear
 Двухвентильный встраиваемый для ванны с изливом из стены

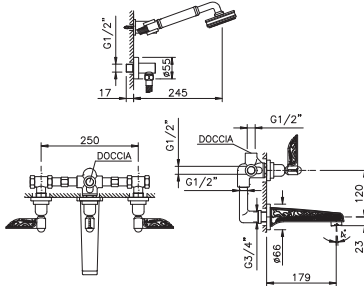

Finitura / Finishing

16

CR NL OG OL OS 806,00

FINITURE SPECIALI *
SPECIAL FINISHING 1.088,00

GO RG 1.282,00

Art. 1004

Gruppo bordo vasca 4 fori

Bathtub mixer on edge type with 4 holes
 Mélangeur bain sur le bord avec 4 trous
 Gruppe für 4-Loch Badewannenrand

Mezclador de repisa para baño-ducha
 Grupo lateral de banheira de 4 furos
 Двухвентильный на 4 отверстия на борт ванны

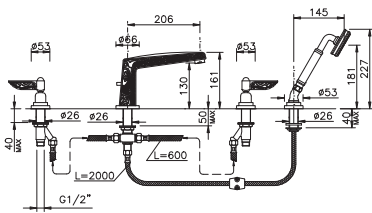

Finitura / Finishing

16

CR NL OG OL OS 1.010,00

FINITURE SPECIALI *
SPECIAL FINISHING 1.363,00

GO RG 1.606,00

Art. 1077

Batteria lavabo a parete

Wash basin wall mounted
 Mélangeur lavabo mural
 Waschbecken am Wand

Lavabo de pared
 Lavatorio ligação a parede
 Двухвентильный настенный для раковины

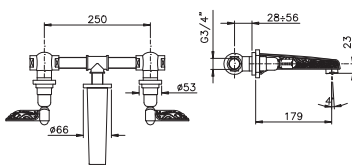

Finitura / Finishing

16

CR NL OG OL OS 618,00

FINITURE SPECIALI *
SPECIAL FINISHING 835,00

GO RG 983,00

LIBERTY

Con vitone ceramico / With ceramic cartridge / Avec cartouche ceramice / Mit oberteil aus keramik / Con cabeza ceramica / Com cabeça ceramica

Art. 1008

Batteria lavabo scarico automatico

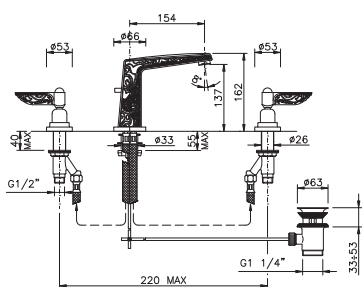
Wash basin mixer with automatic pop-up waste
Mélangeur pour lavabo avec vidage automatique
Waschbeckenbatterie mit automatischem AblaufBateria lavabo desagüe automático
Grupo lavatorio c/v.d.a.
Двухвентильный на 3 отв.с для раковины

Finitura / Finishing

16

CR NL OG OL OS 618,00

FINITURE SPECIALI *
SPECIAL FINISHING 835,00

GO RG 979,00

Art. 1010

Combinazione bidet

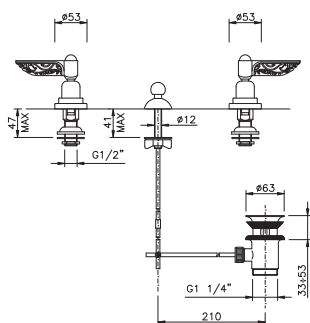
Bidet mixer with automatic pop-up waste
Mélangeur pour bidet avec vidage automatique
Kombination Bidet mit automatischem AblaufCombinación bidé desagüe automático
Combinacao bidet c/v.d.a.
Двухвентильный на 3 отверстия для биде

Finitura / Finishing

16

CR NL OG OL OS 449,00

FINITURE SPECIALI *
SPECIAL FINISHING 606,00

GO RG 713,00

Art. 1012

Rubinetto d'arresto

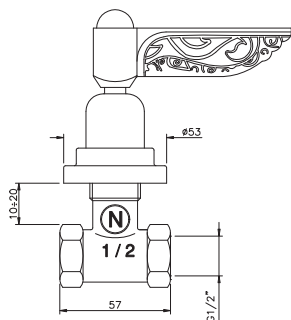
Built-in stop cock 1/2"
Robinet arrêt 1/2"
Unterputz-Sperventil 1/2"üVálvula de cierre empotrado 1/2"
Passador de encastrar 1/2"
Вентиль запорный 1/2"

Finitura / Finishing

16

CR NL OG OL OS 186,00

FINITURE SPECIALI *
SPECIAL FINISHING 251,00

GO RG 296,00

Art. 1025

Gruppo doccia esterno (senza flex e doccia)

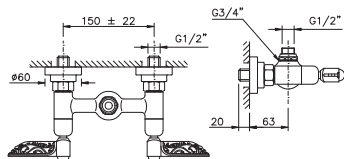
Shower mixer external type, without duplex
Mélangeur douche extérieure, sans duplex
Aufputz-Duschengruppe ohne flexibler und DuscheGrupo ducha externo sin flexible y ducha
Misturadora base chuveiro
Двухвентильный для душа (без гибкого шланга и лейки)

Finitura / Finishing

16

CR NL OG OL OS 443,00

FINITURE SPECIALI *
SPECIAL FINISHING 599,00

GO RG 705,00

LIBERTY

Con vitone ceramico / With ceramic cartridge / Avec cartouche ceramique / Mit oberteil aus keramik / Con cabeza ceramica / Com cabeça ceramica

Art. 1047

Rubinetto lavatrice 3/4" con attacco flex 1/2"

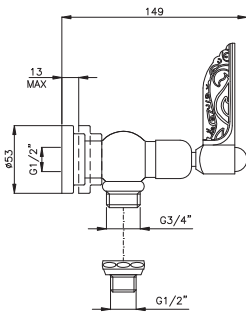

Single tap with washing machine connection 3/4"
 Robinet avec raccordement pour machine à laver 3/4"
 Waschmaschinenarmatur 3/4"

Grifo para lavadora 3/4"
 Torneria de esquadria
 Вентиль запорный для стиральной машины

Finitura / Finishing

16

CR NL OG OL OS	209,00
FINITURE SPECIALI * SPECIAL FINISHING	282,00
GO RG	330,00

Complemento doccia LIBERTY

C7114

Doccia Liberty

Liberty hand shower
 Douchette Liberty
 Handbrause Liberty

Ducha Liberty
 Chuveiro Liberty
 Лейка Liberty



Finitura / Finishing

CR NL OG OL OS	150,00
FINITURE SPECIALI * SPECIAL FINISHING	210,00
GO RG	285,00

serie tradizionali

traditional series

■ ARENA



■ AGORÀ

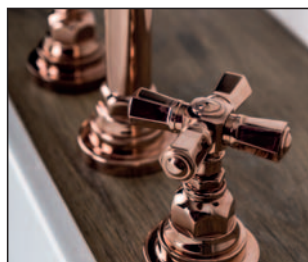

Nicolazzi

ARENA



CL - Bianco Opaco / Matt White

Ecologico
PRODOTTO SENZA PIOMBO E NICKEL
CON OTTONE IN LEGA ANTIDIZINCIFICANTE
LEAD AND NICKEL FREE
BRASS ALLOY WITHOUT ZINC

Nicolazzi



05 - Ottone Spazzolato / *Brushed Brass*



ARENA



CL - Nero Opaco / *Matt Black*

Arena



3302 Gruppo vasca esterno con doccia duplex
Bath tub set with duplex shower



3303 Gruppo vasca incasso erogazione a parete
Bath tub set, wall mtg. central "sail" spout



3325 Gruppo doccia esterno (senza flex e doccia)
Shower mixer external type, without duplex



3307 Batteria lavabo a parete
Wash basin wall mounted



3308 Batteria lavabo scarico automatico
Wash basin mixer with automatic pop-up waste



3318 Batteria lavabo scarico automatico
Wash basin mixer with automatic pop-up waste



3328 Batteria lavabo scarico automatico
Wash basin mixer with automatic pop-up waste



3310 Combinazione bidet
Bidet mixer with automatic pop-up waste



3315 Batteria per bidet esterna
Outer group for bidet



3312 Rubinetto d'arresto incasso 1/2"
Built-in stop cock 1/2"



3336 Monoforo lavabo scarico automatico
Basin single-hole mixer with automatic pop-up waste



3337 Monoforo bidet scarico automatico
Bidet single-hole mixer with automatic pop-up waste



3314 Gruppo bordo vasca 5 fori
Bath tub mixer on edge type with 5 holes



3324 Gruppo bordo vasca 5 fori
Bath tub mixer on edge type with 5 holes



****44 Arena**

ARENA

Con vitone ceramico / With ceramic cartridge / Avec cartouche ceramique / Mit oberteil aus keramik / Con cabeza ceramica / Com cabeça ceramica

Art. 3302

Gruppo vasca esterno con doccia duplex

Bathtub set with duplex shower
Mélangeur bain avec douche duplex
Aufputs-Badewannengruppe mit duplex Handbrause

Mezclador exterior para baño-ducha
Misturadora de banheira c/flexivel
Двухвентильный с душем duplex для ванны

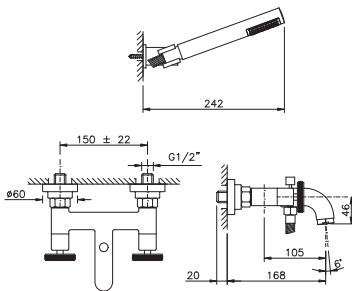

Finitura / Finishing

44

CR NL OG OL OS 367,00

FINITURE SPECIALI *
SPECIAL FINISHING 592,00

GO RG 804,00

Optional Art. 5573 pag. 91

Art. 3303

Gruppo vasca incasso erogazione a parete

Bathtub set, wall mtg. central "sail" spout
Mélangeur bain à encastrer
Unterputz-Badewannengruppe mit Wanduslauf

Grupo bañera empotrado erogación de pared
Grupo de banheira de ancastrar
Двухвентильный встраиваемый для ванны с изливом из стены

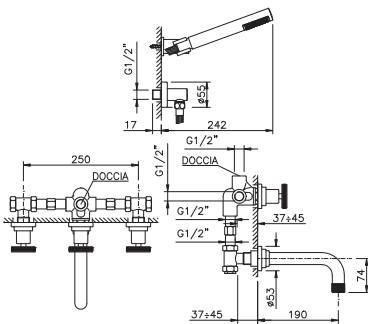

Finitura / Finishing

44

CR NL OG OL OS 541,00

FINITURE SPECIALI *
SPECIAL FINISHING 764,00

GO RG 1.074,00

Art. 3325

Gruppo doccia esterno (senza flex e doccia)

Shower mixer external type, without duplex
Mélangeur douche extérieure, sans duplex
Aufputz-Duschengruppe ohne flexibler und Dusche

Grupo ducha externo sin flexible y ducha
Misturadora base chuveiro
Двухвентильный для душа (без гибкого шланга и лейки)

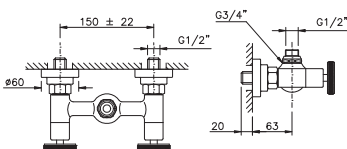

Finitura / Finishing

44

CR NL OG OL OS 175,00

FINITURE SPECIALI *
SPECIAL FINISHING 217,00

GO RG 297,00

ARENA

Con vitone ceramico / With ceramic cartridge / Avec cartouche ceramice / Mit oberteil aus keramik / Con cabeza ceramica / Com cabeça ceramica

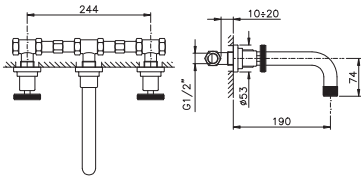
Art. **3307***Batteria lavabo a parete*Wash basin wall mounted
Mélangeur lavabo mural
Waschbecken am WandLavabo de pared
Lavatorio ligação a parede
Двухвентильный настенный для раковины

Finitura / Finishing

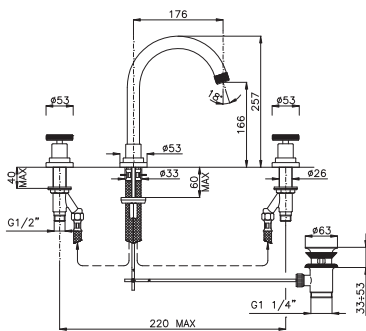
44CR NL OG OL OS **270,00**FINITURE SPECIALI *
SPECIAL FINISHING **461,00**GO RG **631,00**Art. **3308***Batteria lavabo scarico automatico*Wash basin mixer with automatic pop-up waste
Mélangeur pour lavabo avec vidage automatique
Waschbeckenbatterie mit automatischem AblaufMezclador lavabo con caño central
Grupo lavatorio c/v.d.a.
Двухвентильный на 3 отв. с функцией слива для раковины

Finitura / Finishing

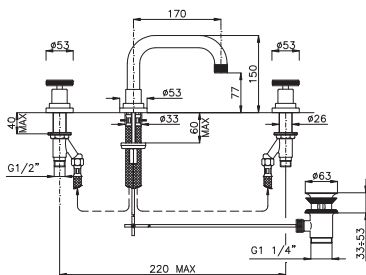
44CR NL OG OL OS **327,00**FINITURE SPECIALI *
SPECIAL FINISHING **461,00**GO RG **631,00**Art. **3318***Batteria lavabo scarico automatico*Wash basin mixer with automatic pop-up waste
Mélangeur pour lavabo avec vidage automatique
Waschbeckenbatterie mit automatischem AblaufMezclador lavabo con caño central
Grupo lavatorio c/v.d.a.
Двухвентильный на 3 отв. с функцией слива для раковины

Finitura / Finishing

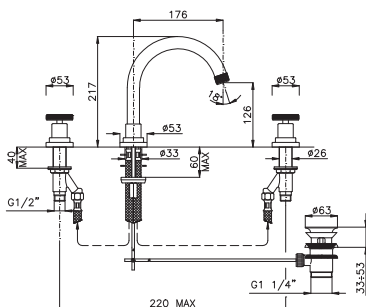
44CR NL OG OL OS **327,00**FINITURE SPECIALI *
SPECIAL FINISHING **461,00**GO RG **631,00**Art. **3328***Batteria lavabo scarico automatico*Wash basin mixer with automatic pop-up waste
Mélangeur pour lavabo avec vidage automatique
Waschbeckenbatterie mit automatischem AblaufMezclador lavabo con caño central
Grupo lavatorio c/v.d.a.
Двухвентильный на 3 отв. с функцией слива для раковины

Finitura / Finishing

44CR NL OG OL OS **327,00**FINITURE SPECIALI *
SPECIAL FINISHING **461,00**GO RG **631,00**

ARENA

Con vitone ceramico / With ceramic cartridge / Avec cartouche ceramique / Mit oberteil aus keramik / Con cabeza ceramica / Com cabeça ceramica

Art. 3310

Combinazione bidet

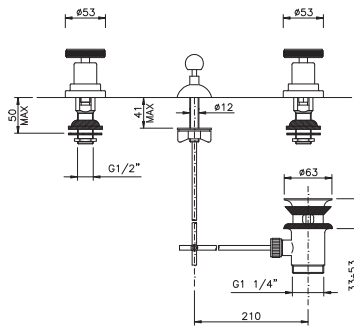

Bidet mixer with automatic pop-up waste
Mélangeur pour bidet avec vidage automatique
Kombination Bidet mit automatischem Ablauf

Combinacón bidé desagüe automático
Combinacão bidet c/v.d.a.
Двухвентильный с автоматическим сливом для биде

Finitura / Finishing

44

CR NL OG OL OS 184,00

FINITURE SPECIALI *
SPECIAL FINISHING 336,00

GO RG 461,00

Art. 3315

Batteria per bidet esterna

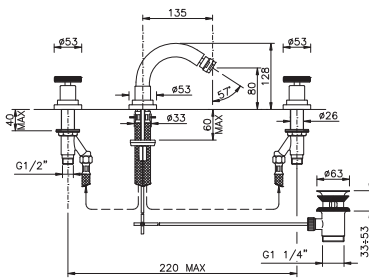

Outer group for bidet
Groupe extérieur pour bidet
Außengruppe für Bidet

Mezclador bidé con caõ central
Grupo exterior para bidé
Двухвентильный с автоматическим сливом для биде

Finitura / Finishing

44

CR NL OG OL OS 319,00

FINITURE SPECIALI *
SPECIAL FINISHING 461,00

GO RG 631,00

Art. 3311

Batteria bidet con doccetta

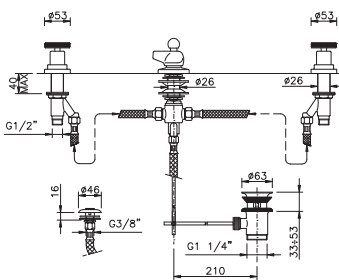

Bidet set with shower
Mélangeur de bidet avec douche
Bidetbatterie mit Handbrause

Combinacón bidé con churro ducha
Combinacão bidet c/repuxo
Двухвентильный с душиком на 3 отверстия для биде

Finitura / Finishing

44

CR NL OG OL OS 368,00

FINITURE SPECIALI *
SPECIAL FINISHING 530,00

GO RG 719,00

Art. 3312

Rubinetto d'arresto incasso 1/2"

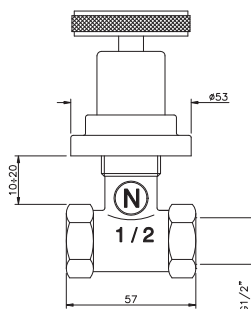

Built-in stop cock 1/2"
Robinet arrêt 1/2"
Unterputz-Sperventil 1/2"

Válvula de cierre empotrada 1/2"
Passador de encastrar 1/2"
Вентиль запорный 1/2"

Finitura / Finishing

44

CR NL OG OL OS 93,00

FINITURE SPECIALI *
SPECIAL FINISHING 122,00

GO RG 162,00

ARENA

Con vitone ceramico / With ceramic cartridge / Avec cartouche ceramice / Mit oberteil aus keramik / Con cabeza ceramica / Com cabeça ceramica

Art. **3336**

Monoforo lavabo scarico automatico

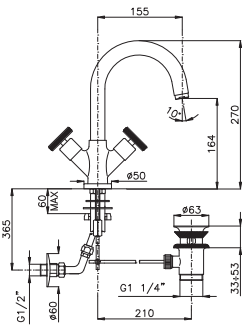

Basin single-hole mixer with automatic pop-up waste
Mélangeur lavabo monotrou avec vidage automatique
Einloch-Waschbecken mit automatischem Ablauf

Monohueco lavabo con desagüe automático
Monofuro lavatorio c/v.d.a.
Двухвентильный с автоматическим сливом для раковины

Finitura / Finishing

44CR NL OG OL OS **312,00**FINITURE SPECIALI *
SPECIAL FINISHING **423,00**GO RG **626,00**Art. **3337**

Monoforo bidet scarico automatico

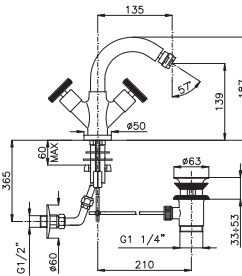

Bidet single-hole mixer with automatic pop-up waste
Mélangeur bidet monotrou avec vidage automatique
Einloch-Bidet mit automatischem Ablauf

Monohueco lbidé con desagüe automático
Monofuro bidet c/v.d.a.
Двухвентильный с автоматическим сливом для биде

Finitura / Finishing

44CR NL OG OL OS **297,00**FINITURE SPECIALI *
SPECIAL FINISHING **406,00**GO RG **615,00**Art. **3314**

Gruppo bordo vasca 5 fori

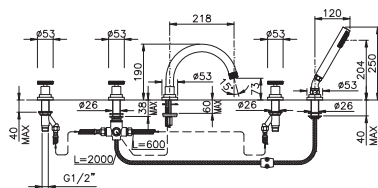

Bathtub mixer on edge type with 5 holes
Mélangeur bain sur le bord avec 5 trous
Gruppe für 5-Loch Badewannenrand

Mezclador de repisa para baño-ducha
Grupo lateral de banheira de 5 furos
Двухвентильный на 5 отверстий на борт ванны

Finitura / Finishing

44CR NL OG OL OS **630,00**FINITURE SPECIALI *
SPECIAL FINISHING **861,00**GO RG **1.224,00**Art. **3324**

Gruppo bordo vasca 5 fori

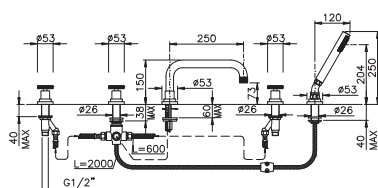

Bathtub mixer on edge type with 5 holes
Mélangeur bain sur le bord avec 5 trous
Gruppe für 5-Loch Badewannenrand

Mezclador de repisa para baño-ducha
Grupo lateral de banheira de 5 furos
Двухвентильный на 5 отверстий на борт ванны

Finitura / Finishing

44CR NL OG OL OS **630,00**FINITURE SPECIALI *
SPECIAL FINISHING **861,00**GO RG **1.224,00**

■ AGORÀ



05 - Ottone Spazzolato / *Brushed Brass*



AGORÀ



RG - Oro Rosa / Rose Gold

Agorà



2302 Gruppo vasca esterno con doccia duplex
Bathub set with duplex shower



2325 Gruppo doccia esterno (senza flex e doccia)
Shower mixer external type, without duplex



2308 Batteria lavabo scarico automatico
Wash basin mixer with automatic pop-up waste



2310 Combinazione bidet
Bidet mixer with automatic pop-up waste



2312 Rubinetto d'arresto incasso 1/2"
Built-in stop cock 1/2"



2336 Monoforo lavabo scarico automatico
Basin single-hole mixer with automatic pop-up waste



2337 Monoforo bidet scarico automatico
Bidet single-hole mixer with automatic pop-up waste



**** 45IN**



****05IN**



****18IN**

Art. 2302

Gruppo vasca esterno con doccia duplex

Bathtub set with duplex shower
Mélangeur bain avec douche duplex
Aufputs-Badewannengruppe mit duplex Handbrause

Mezclador exterior para baño-ducha
Misturadora de banheira c/flexivel
Двухвентильный с душем duplex для ванны

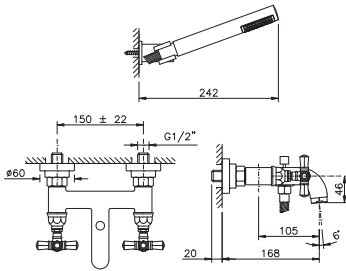

Optional Art. 5573 pag. 91

Finitura / Finishing	45IN	05IN	18IN
CR NL OG OL OS	441,00	355,00	319,00
FINITURE SPECIALI * SPECIAL FINISHING	637,00	551,00	515,00
GO RG	821,00	735,00	699,00

Art. 2303

Gruppo vasca incasso erogazione a parete

Bathtub set, wall mtg. central "sail" spout
Mélangeur bain à encastrer
Unterputz-Badewannengruppe mit Wanduslauf

Grupo bañera empotrado erogación de pared
Grupo de banheira de ancastrar
Двухвентильный встраиваемый для ванны с изливом из стены

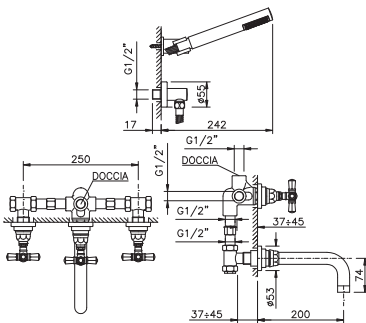

Finitura / Finishing	45IN	05IN	18IN
CR NL OG OL OS	653,00	524,00	470,00
FINITURE SPECIALI * SPECIAL FINISHING	847,00	718,00	664,00
GO RG	1.117,00	988,00	934,00

Art. 2325

Gruppo doccia esterno (senza flex e doccia)

Shower mixer external type, without duplex
Mélangeur douche extérieure, sans duplex
Aufputz-Duschengruppe ohne flexibler und Dusche

Grupo ducha externo sin flexible y ducha
Misturadora base chuveiro
Двухвентильный для душа (без гибкого шланга и лейки)

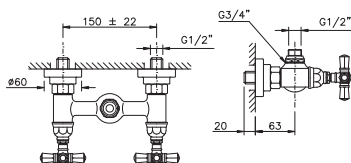

Finitura / Finishing	45IN	05IN	18IN
CR NL OG OL OS	274,00	188,00	152,00
FINITURE SPECIALI * SPECIAL FINISHING	311,00	225,00	189,00
GO RG	380,00	294,00	258,00

AGORÀ

Con vitone ceramico / With ceramic cartridge / Avec cartouche ceramice / Mit oberteil aus keramik / Con cabeza ceramica / Com cabeça ceramica

Art. 2307

Batteria lavabo a parete

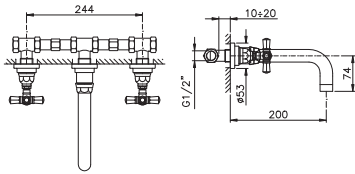
Wash basin wall mounted
Mélangeur lavabo mural
Waschbecken am WandLavabo de pared
Lavatorio ligação a parede
Двухвентильный настенный для раковины

Finitura / Finishing	45IN	05IN	18IN
CR NL OG OL OS	357,00	271,00	235,00
FINITURE SPECIALI * SPECIAL FINISHING	523,00	437,00	401,00
GO RG	671,00	585,00	549,00

Art. 2308

Batteria lavabo scarico automatico

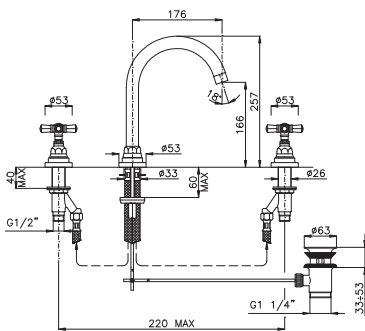
Wash basin mixer with automatic pop-up waste
Mélangeur pour lavabo avec vidage automatique
Waschbeckenbatterie mit automatischem AblaufMezclador lavabo con caño central
Grupo lavatorio c/v.d.a.
Двухвентильный на 3 отв.с функцией слива для раковины

Finitura / Finishing	45IN	05IN	18IN
CR NL OG OL OS	406,00	320,00	284,00
FINITURE SPECIALI * SPECIAL FINISHING	523,00	437,00	401,00
GO RG	671,00	585,00	549,00

Art. 2318

Batteria lavabo scarico automatico

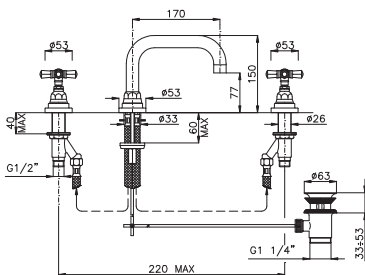
Wash basin mixer with automatic pop-up waste
Mélangeur pour lavabo avec vidage automatique
Waschbeckenbatterie mit automatischem AblaufMezclador lavabo con caño central
Grupo lavatorio c/v.d.a.
Двухвентильный на 3 отв.с функцией слива для раковины

Finitura / Finishing	45IN	05IN	18IN
CR NL OG OL OS	406,00	320,00	284,00
FINITURE SPECIALI * SPECIAL FINISHING	523,00	437,00	401,00
GO RG	671,00	585,00	549,00

Art. 2328

Batteria lavabo scarico automatico

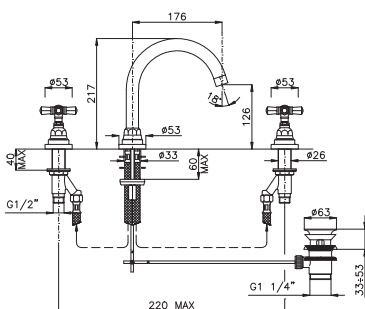
Wash basin mixer with automatic pop-up waste
Mélangeur pour lavabo avec vidage automatique
Waschbeckenbatterie mit automatischem AblaufMezclador lavabo con caño central
Grupo lavatorio c/v.d.a.
Двухвентильный на 3 отв.с функцией слива для раковины

Finitura / Finishing	45IN	05IN	18IN
CR NL OG OL OS	406,00	320,00	284,00
FINITURE SPECIALI * SPECIAL FINISHING	523,00	437,00	401,00
GO RG	671,00	585,00	549,00

AGORÀ

Con vitone ceramico / With ceramic cartridge / Avec cartouche ceramique / Mit oberteil aus keramik / Con cabeza ceramica / Com cabeça ceramica

Art. 2310

Combinazione bidet

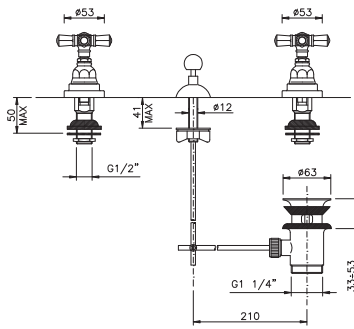

Bidet mixer with automatic pop-up waste
Mélangeur pour bidet avec vidage automatique
Kombination Bidet mit automatischem Ablauf

Combinacón bidé desagüe automático
Combinacão bidet c/v.d.a.
Двухвентильный с автоматическим сливом для биде

Finitura / Finishing	45IN	05IN	18IN
CR NL OG OL OS	282,00	196,00	160,00
FINITURE SPECIALI * SPECIAL FINISHING	414,00	328,00	292,00
GO RG	523,00	437,00	401,00

Art. 2315

Batteria per bidet esterna

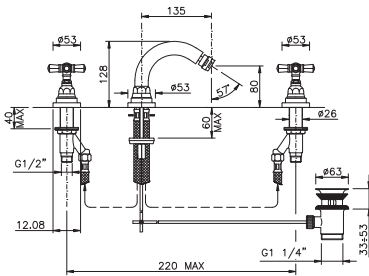

Outer group for bidet
Groupe extérieur pour bidet
Außengruppe für Bidet

Mezclador bidé con caõ central
Grupo exterior para bidé
Двухвентильный с автоматическим сливом для биде

Finitura / Finishing	45IN	05IN	18IN
CR NL OG OL OS	399,00	313,00	277,00
FINITURE SPECIALI * SPECIAL FINISHING	523,00	437,00	401,00
GO RG	671,00	585,00	549,00

Art. 2311

Batteria bidet con doccetta

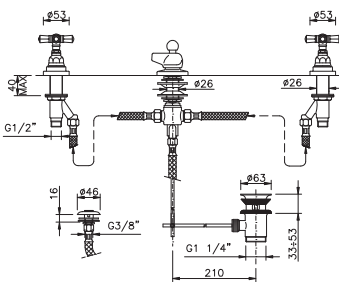

Bidet set with shower
Mélangeur de bidet avec douche
Bidetbatterie mit Handbrause

Combinacón bidé con churro ducha
Combinacão bidet c/repicho
Двухвентильный с душиком на 3 отверстия для биде

Finitura / Finishing	45IN	05IN	18IN
CR NL OG OL OS	442,00	356,00	320,00
FINITURE SPECIALI * SPECIAL FINISHING	583,00	497,00	461,00
GO RG	747,00	661,00	625,00

Art. 2312

Rubinetto d'arresto incasso 1/2"

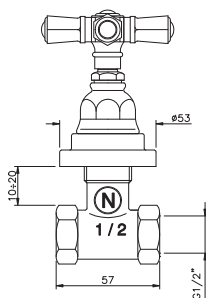

Built-in stop cock 1/2"
Robinet arrê 1/2"
Unterputz-Sperventil 1/2"

Válvula de cierre empotrada 1/2"
Passador de encastrar 1/2"
Вентиль запорный 1/2"

Finitura / Finishing	45IN	05IN	18IN
CR NL OG OL OS	142,00	99,00	81,00
FINITURE SPECIALI * SPECIAL FINISHING	167,00	124,00	106,00
GO RG	202,00	159,00	141,00

AGORÀ

Con vitone ceramico / With ceramic cartridge / Avec cartouche ceramice / Mit oberteil aus keramik / Con cabeza ceramica / Com cabeça ceramica

Art. 2336

Monoforo lavabo scarico automatico

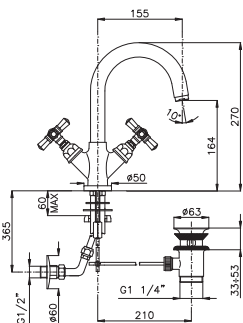

Basin single-hole mixer with automatic pop-up waste
Mélangeur lavabo monotrou avec vidage automatique
Einloch-Waschbecken mit automatischem Ablauf

Monohueco lavabo con desagüe automático
Monofuro lavatorio c/v.d.a.
Двухвентильный с автоматическим сливом для раковины

Finitura / Finishing

45IN 18IN

CR NL OG OL OS 393,00 271,00

FINITURE SPECIALI *
SPECIAL FINISHING 490,00 368,00

GO RG 666,00 544,00

Art. 2337

Monoforo bidet scarico automatico

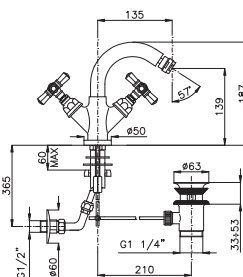

Bidet single-hole mixer with automatic pop-up waste
Mélangeur bidet monotrou avec vidage automatique
Einloch-Bidet mit automatischem Ablauf

Monohueco lbidé con desagüe automático
Monofuro bidet c/v.d.a.
Двухвентильный с автоматическим сливом для биде

Finitura / Finishing

45IN 18IN

CR NL OG OL OS 380,00 258,00

FINITURE SPECIALI *
SPECIAL FINISHING 475,00 353,00

GO RG 657,00 535,00

Art. 2314

Gruppo bordo vasca 5 fori

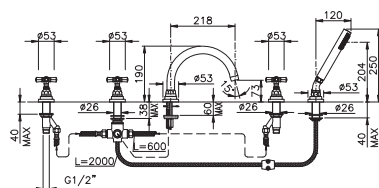

Bathtub mixer on edge type with 5 holes
Mélangeur bain sur le bord avec 5 trous
Gruppe für 5-Loch Badewannenrand

Mezclador de repisa para baño-ducha
Grupo lateral de banheira de 5 furos
Двухвентильный на 5 отверстий на борт ванны

Finitura / Finishing

45IN 05IN 18IN

CR NL OG OL OS 731,00 602,00 548,00

FINITURE SPECIALI *
SPECIAL FINISHING 932,00 803,00 749,00

GO RG 1.247,00 1.118,00 1.064,00

Art. 2324

Gruppo bordo vasca 5 fori

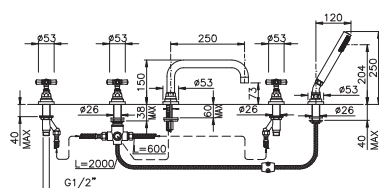

Bathtub mixer on edge type with 5 holes
Mélangeur bain sur le bord avec 5 trous
Gruppe für 5-Loch Badewannenrand

Mezclador de repisa para baño-ducha
Grupo lateral de banheira de 5 furos
Двухвентильный на 5 отверстий на борт ванны

Finitura / Finishing

45IN 05IN 18IN

CR NL OG OL OS 731,00 602,00 548,00

FINITURE SPECIALI *
SPECIAL FINISHING 932,00 803,00 749,00

GO RG 1.247,00 1.118,00 1.064,00

serie
monocomandi
single-lever series

■ TORRE



■ ARENA



Nicolazzi

Torre



3901 *Monocomando vasca esterno con doccia*
Single-lever bath mixer with shower



3902 *Monocomando per lavabo con scarico automatico*
Single-lever wash basin mixer



3903 *Monocomando per bidet con scarico automatico*
Single-lever bidet mixer



3905 *Monocomando doccia esterno*
Single-lever shower mixer, external wall type



3925 *Monocomando doccia esterno*
Single-lever shower mixer, external wall type



3996 *Monocomando doccia incasso con deviatore*
Single-lever for built-in shower with diverter



3906 *Parte esterna monocomando doccia incasso*
Ext. part of single-lever for built-in shower

■ TORRE



05 - Ottone Spazzolato / *Brushed Brass*

Ecologico
PRODOTTO SENZA PIOMBO E NICHEL
CON OTTONE IN LEGA ANTIDIZINCIFICANTE
LEAD AND NICKEL FREE
BRASS ALLOY WITHOUT ZINC

Nicolazzi

MONOCOMANDO TORRE

Con cartuccia / With cartridge / Avec cartouche / Mit kartusche / Con cartucho / Com cartucho

Art. 3901

Monocomando vasca esterno con doccia

Single-lever bath mixer with shower
Mélangeur bain monolevier avec douche
Einhebel-Waschbecken mit duplex Handbrause

Monomando bañera-ducha con accesorios
Monocomando de banheira completa
Однорычажный настенный с душем для ванны

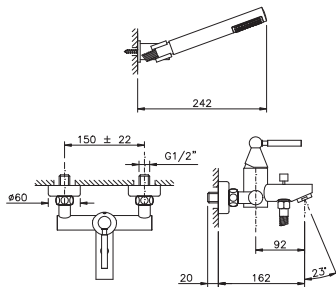

Optional Art. 5573 pag. 91

Finitura / Finishing

CR NL OG OL OS 286,00

FINITURE SPECIALI *
SPECIAL FINISHING 389,00

GO RG 470,00

Art. 3902

Monocomando per lavabo con scarico automatico

Single-lever wash basin mixer
Mélangeur pour lavabo monolevier
Einhebel-Waschbecken

Monomando lavabo
Monocomando do lavatorio
Однорычажный с автоматическим сливом для раковины

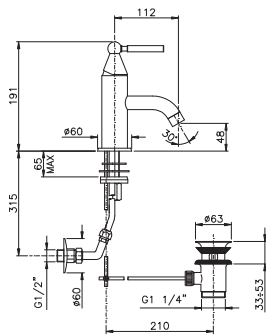

Finitura / Finishing

CR NL OG OL OS 244,00

FINITURE SPECIALI *
SPECIAL FINISHING 332,00

GO RG 400,00

Art. 3922

Monocomando per lavabo con scarico automatico

Single-lever wash basin mixer
Mélangeur pour lavabo monolevier
Einhebel-Waschbecken

Monomando lavabo
Monomando de lavatorio c/v.d.a.
Однорычажный с автоматическим сливом для раковины

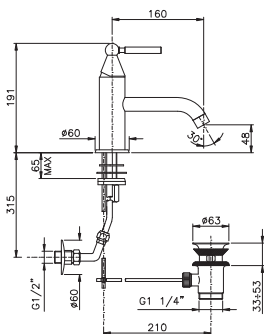

Finitura / Finishing

CR NL OG OL OS 271,00

FINITURE SPECIALI *
SPECIAL FINISHING 365,00

GO RG 448,00

Art. 3903

Monocomando per bidet con scarico automatico

Single-lever bidet mixer
Mélangeur pour bidet monolevier
Einhebel-Bidet mit Automatischem Ablauf

Monomando bidé
Monocomando de bidet c/v.d.a.
Однорычажный высокий для раковины

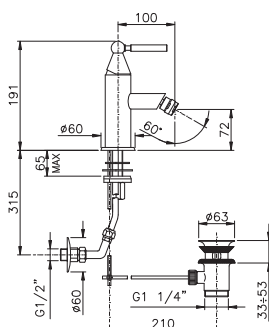

Finitura / Finishing

CR NL OG OL OS 244,00

FINITURE SPECIALI *
SPECIAL FINISHING 332,00

GO RG 400,00

MONOCOMANDO TORRE

Con cartuccia / With cartridge / Avec cartouche / Mit kartusche / Con cartucho / Com cartucho

Art. 3905

Monocomando doccia esterno

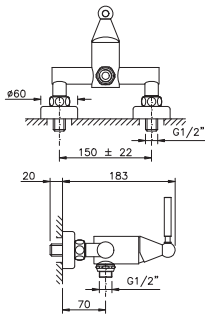

Single-lever shower mixer, external wall type
Mélangeur monolevier, pour douche extérieure
Aufputz-Einhebel-Dusche

Monomando ducha
Monocomando lde base chuveiro
Однорычажный настенный для душа

Finitura / Finishing

CR NL OG OL OS	186,00
FINITURE SPECIALI * SPECIAL FINISHING	254,00
GO RG	306,00

Art. 3906

Monocomando doccia incasso

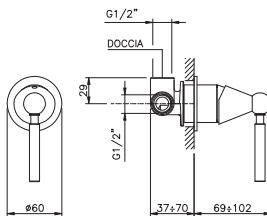

Single-lever for built-in shower
Mono-commande douche encaissé
Unterputz-Einhebel-Dusche

Monomando ducha empotrado
Monomando ducha encastrado
Однорычажный встраиваемый для душа

Finitura / Finishing

CR NL OG OL OS	132,00
FINITURE SPECIALI * SPECIAL FINISHING	181,00
GO RG	211,00

Art. 3925

Monocomando doccia esterno

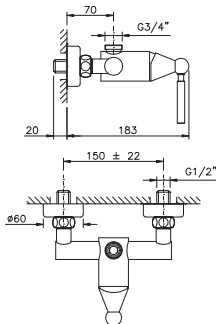

Single-lever shower mixer, external wall type
Mélangeur monolevier, pour douche extérieure
Aufputz-Einhebel-Dusche

Monomando ducha
Monocomando lde base chuveiro
Однорычажный настенный для душа

Finitura / Finishing

CR NL OG OL OS	186,00
FINITURE SPECIALI * SPECIAL FINISHING	254,00
GO RG	306,00

Art. 3972 - 3982

Monocomando lavabo alto

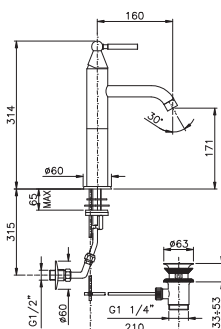

Single-lever high basin mixer
Mélangeur lavabo haut
Einhebel-Hochwshbcken

Monomando lavabo alto
Monomando de lavatorio elevado
Однорычажный высокий для раковины

Finitura / Finishing

Finitura / Finishing	testa cieca / without pop-up waste / sans vidage mit Blindkopf / cabeza cieca / s/v.d.a.	scarico automatico / with pop-up waste / avec vidage mit Ablauf / con desagüe / c/v.d.a.
	3972	3982
CR NL OG OL OS	257,00	271,00
FINITURE SPECIALI * SPECIAL FINISHING	351,00	365,00
GO RG	424,00	448,00

MONOCOMANDO TORRE

Con cartuccia / With cartridge / Avec cartouche / Mit kartusche / Con cartucho / Com cartucho

Art. 3978

Monocomando lavabo incasso

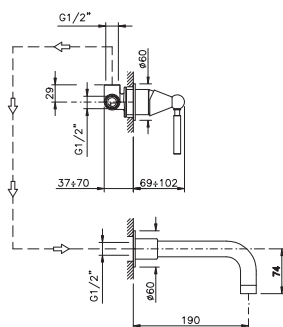

Single-lever wall mounted basin mixer
Mélangeur lavabo encaiss
Waschtisch eingelassen

Monomando lavabo empotrado
Monomando de lavatório encastrado
однорычажный для умывальника встраиваемые

Finitura / Finishing

CR NL OG OL OS	255,00
FINITURE SPECIALI * SPECIAL FINISHING	385,00
GO RG	490,00

Art. 3996

Monocomando doccia incasso con deviatore

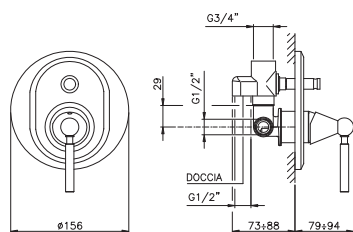

Single-lever for built-in shower with diverter
Mono-commande douche encaiss avec aiguillage
Einhebel eingebiltten Dusche mit Ablenker

Monomando ducha empotrado con desviador
Monocomando do chuveiro encastrado com desviador
Однорычажный встраиваемый с переключ. для душа

Finitura / Finishing

CR NL OG OL OS	186,00
FINITURE SPECIALI * SPECIAL FINISHING	254,00
GO RG	306,00

■ ARENA



05 - Ottone Spazzolato / *Brushed Brass*

Ecologico
PRODOTTO SENZA PIOMBO E NICKEL
CON OTTONE IN LEGA ANTIDIZINCIFICANTE
LEAD AND NICKEL FREE
BRASS ALLOY WITHOUT ZINC

Nicolazzi

Arena



4101 *Monocomando vasca esterno con doccia*
Single-lever bath mixer with shower



4102 *Monocomando per lavabo con scarico automatico*
Single-lever wash basin mixer



4103 *Monocomando per bidet con scarico automatico*
Single-lever bidet mixer



4105 *Monocomando doccia esterno*
Single-lever shower mixer, external wall type



4125 *Monocomando doccia esterno*
Single-lever shower mixer, external wall type



4196 *Monocomando doccia incasso con deviatore*
Single-lever for built-in shower with diverter



4106 *Parte esterna monocomando doccia incasso*
Ext. part of single-lever for built-in shower



****48 Arena**

MONOCOMANDO ARENA

Con cartuccia progressiva / With progressive cartridge / Avec cartouche progressive / Mit progressiver Kartusche / Con el cartucho progresivo / Com cartucho progresivo

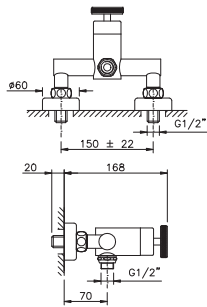

Art. 4105

Monocomando doccia esterno

Single-lever shower mixer, external wall type
Mélangeur monolevier, pour douche extérieure
Aufputz-Einhebel-Dusche

Monomando ducha
Monocomando lde base chuveiro
Однорычажный настенный для душа

Finitura / Finishing

48

CR NL OG OL OS 186,00

FINITURE SPECIALI *
SPECIAL FINISHING 254,00

GO RG 306,00

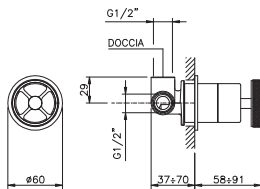

Art. 4106

Monocomando doccia incasso

Single-lever for built-in shower
Mono-commande douche encaissé
Unterputz-Einhebel-Dusche

Monomando ducha empotrado
Monomando ducha encastrado
Однорычажный встраиваемый для душа

Finitura / Finishing

48

CR NL OG OL OS 132,00

FINITURE SPECIALI *
SPECIAL FINISHING 181,00

GO RG 211,00

Art. 4125

Monocomando doccia esterno

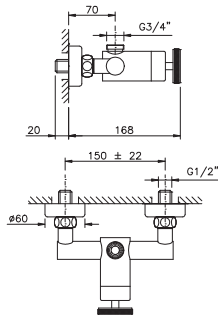

Single-lever shower mixer, external wall type
Mélangeur monolevier, pour douche extérieure
Aufputz-Einhebel-Dusche

Monomando ducha
Monocomando lde base chuveiro
Однорычажный настенный для душа

Finitura / Finishing

48

CR NL OG OL OS 186,00

FINITURE SPECIALI *
SPECIAL FINISHING 254,00

GO RG 306,00

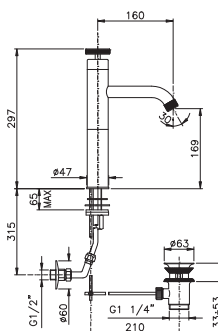

Art. 4172 - 4182

Monocomando lavabo alto

Single-lever high basin mixer
Mélangeur lavabo haut
Einhebel-Hochwschbecken

Monomando lavabo alto
Monomando de lavatorio elevado
Однорычажный высокий для раковины

Finitura / Finishing

testa cieca / without pop-up waste / sans vidage
mit Blindkopf / cabeza cieca / s/v.d.a.scarico automatico / with pop-up waste / avec vidage
mit Ablauf / con desague / c/v.d.a.

4172

4182

CR NL OG OL OS 257,00

271,00

FINITURE SPECIALI *
SPECIAL FINISHING 351,00

365,00

GO RG 424,00

448,00

MONOCOMANDO ARENA

Con cartuccia progressiva / With progressive cartridge / Avec cartouche progressive / Mit progressiver Kartusche / Con el cartucho progresivo / Com cartucho progresivo

Art. 4178

Monocomando lavabo incasso

Single-lever wall mounted basin mixer
Mélangeur lavabo encaiss
Waschtisch eingelassen

Monomando lavabo empotrado
Monomando de lavatorio encastrado
Однорычажный для умывальника встраиваемые

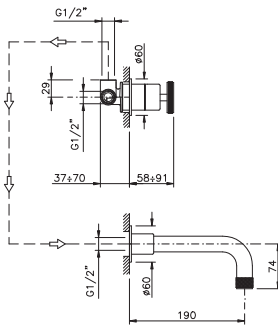

Finitura / Finishing

48

CR NL OG OL OS	255,00
FINITURE SPECIALI * SPECIAL FINISHING	385,00
GO RG	490,00

Art. 4196

Monocomando doccia incasso con deviatore

Single-lever for built-in shower with diverter
Mono-commande douche encaiss avec aiguillage
Einhebel eingebilten Dusche mit Ablenker

Monomando ducha empotrado con desviador
Monocomando do chuveiro encastrado com desviador
Однорычажный встраиваемый с перекл. для душа

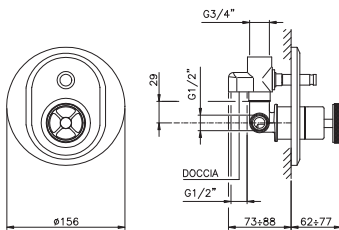

Finitura / Finishing

48

CR NL OG OL OS	186,00
FINITURE SPECIALI * SPECIAL FINISHING	254,00
GO RG	306,00

Programma Cucina



3420 *Monocomando lavello cucina estraibile*
Pull - Down sink mixer with side spray



3430 *Monocomando lavello cucina estraibile*
Pull - Down sink mixer with side spray



3306 *Monoforo lavello*
Single-hole sink mixer



2306 *Monoforo lavello*
Single-hole sink mixer

programma cucina

- KITCHEN PULL-DOWN
- KITCHEN



NS - Nichel Satinato / *Satin Nickel*



CR - Cromo / *Chrome*

Ecologico
 PRODOTTO SENZA PIOMBO E NICHEL
 CON OTTONE IN LEGA ANTIDIZINCIFICANTE
 LEAD AND NICKEL FREE
 BRASS ALLOY WITHOUT ZINC

Nicolazzi

PROGRAMMA CUCINA

Con cartuccia / With cartridge / Avec cartouche / Mit kartusche / Con cartucho / Com cartucho

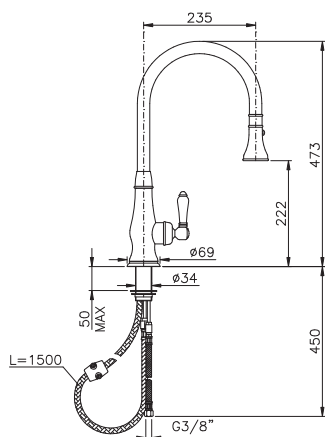
**Kitchen Pull-down Art. 3420***Monocomando lavello doccia estraibile*

One-hole Pull-Down sink mixer with side spray
Mélangeur d'évier mono. avec bec pivotant
Einhebel-Waschbecken mit drehbaren Auslauf

Monomando fregadero encimera
Monocomando lava louça lig. a banca
Смеситель для мойки с выдвигаемым распылителем

Finitura / Finishing	EL CAPITAN	P.M. BLANC	P.M. BLANC A	FOREST
	75P	76P	76AP	77P
CR NL OG OL OS	366,00	374,00	382,00	372,00
FINITURE SPECIALI * SPECIAL FINISHING	504,00	507,00	526,00	511,00
GO RG	768,00	772,00	801,00	779,00

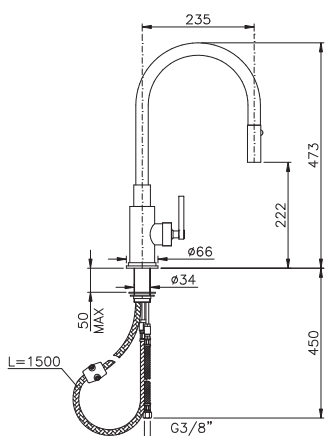
Kitchen Pull-down Art. 3430*Monocomando lavello minimale doccia estraibile*

One-hole Pull-Down sink mixer with side spray
Mélangeur d'évier mono. avec bec pivotant
Einhebel-Waschbecken mit drehbaren Auslauf

Monomando fregadero encimera
Monocomando lava louça lig. a banca
Смеситель для мойки с выдвигаемым распылителем

Finitura / Finishing	
CR NL OG OL OS	366,00
FINITURE SPECIALI * SPECIAL FINISHING	504,00
GO RG	768,00

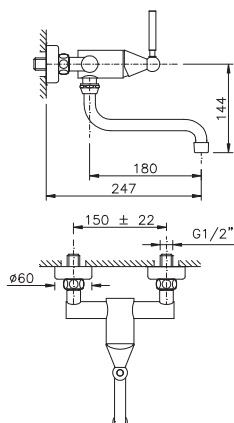
Torre Art. 3904*Monocomando lavello a parete*

Single-lever sink mixer, wall mounted
Mélangeur d'évier monolevier
Wandeinhebel-Waschbecken

Monomando fregadero de pared
Monocomando lava louça lig. a parede
Однорычажный настенный для раковины

Finitura / Finishing	
CR NL OG OL OS	210,00
FINITURE SPECIALI * SPECIAL FINISHING	292,00
GO RG	365,00

PROGRAMMA CUCINA

Con vitone ceramico / With ceramic cartridge / Avec cartouche ceramique / Mit oberteil aus keramik / Con cabeza ceramica / Com cabeça ceramica

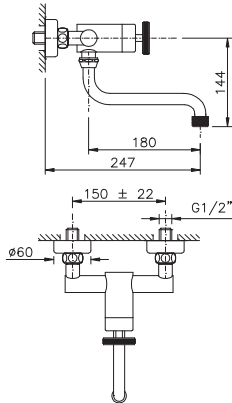
Arena Art. 4104*Monocomando lavello a parete*Single-lever sink mixer, wall mounted
Mélangeur d'évier monolevier
Wandeinhebel-WaschbeckenMonomando fregadero de pared
Monocomando lava louça lig. a parede
Однорычажный настенный для раковины

Finitura / Finishing	ARENA
	48
CR NL OG OL OS	210,00
FINITURE SPECIALI * SPECIAL FINISHING	292,00
GO RG	365,00

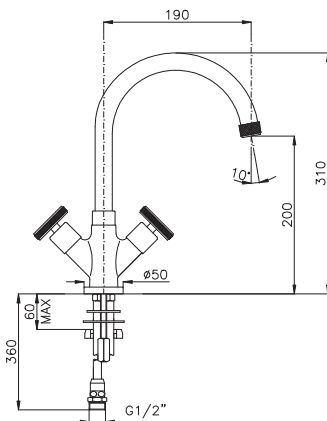
Arena Art. 3306*Monoforo lavello*Single-hole sink mixer
Mélangeur évier monotrou
Einloch-WaschbeckenMezclador fregadero
Monofuro de lava louça
Двухвентильный на 1 отверстие для раковины

Finitura / Finishing	ARENA
	44
CR NL OG OL OS	253,00
FINITURE SPECIALI * SPECIAL FINISHING	312,00
GO RG	444,00

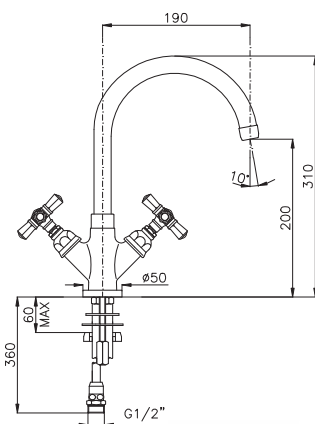
Agorà Art. 2306*Monoforo lavello*Single-hole sink mixer
Mélangeur évier monotrou
Einloch-WaschbeckenMezclador fregadero
Monofuro de lava louça
Двухвентильный на 1 отверстие для раковины****45IN******18IN**

Finitura / Finishing		
	45IN	18IN
CR NL OG OL OS	342,00	220,00
FINITURE SPECIALI * SPECIAL FINISHING	393,00	271,00
GO RG	508,00	386,00

* VEDI TABELLA A PAG. 4 - SEE PAGE 4

Termostatico



4909 *Parte esterna termostatico a incasso da 3/4" con arresto*
Ext. type built-in therm. 3/4"
with stop cock



4914 *Parte esterna termostatico a incasso da 3/4" senza arresto*
Ext. type built-in therm. 3/4"
without stop cock



4912 *Parte esterna rubinetto arresto incasso 3/4"*
External part built-in stop
cock 3/4"



****16**



****05IN**



****18IN**



****45IN**



****44**

■ TERMOSTATICO



TERMOSTATICO

INFORMAZIONI TECNICHE

TECHNICAL INFORMATION - INFORMATIONS TÉCNIQUES - TECHNISCHE INFORMATIONEN

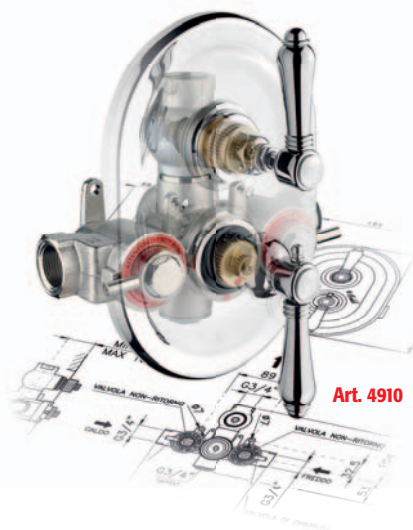

Art. 4910

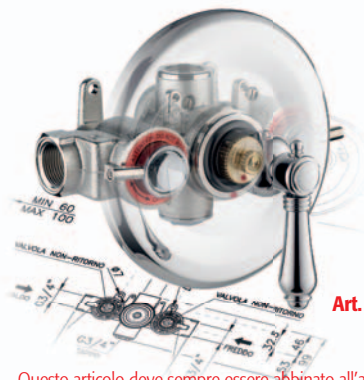

Art. 4913

Questo articolo deve sempre essere abbinato all'art. 4911
This article must always be coupled with art. 4911

INFORMAZIONI TECNICHE

TEMPERATURA DI ALIMENTAZIONE ACQUA CALDA

Minima: 48°C
Massima: 85°C
Consigliata: 60°C

PRESSIONE DI ALIMENTAZIONE

Minima: 1 bar
Massima: 5 bar
Consigliata: 3 bar

IMPORTANTE:

Le pressioni di alimentazione dell'acqua calda e fredda devono essere uguali.
Differenza massima accettata fra le due pressioni: 1 bar.

PORTATA

33 l/min a 2,5 bar

TARATURA DI FABBRICA DELLA CARTUCCIA TERMOSTATICA 38°C.

Parametri di taratura.
Acqua calda: 60°C/3 bar
Acqua fredda: 15°C/3 bar

ATTACCHI

Entrata acqua calda e fredda = G 3/4"
Uscita doccia e vasca = G 3/4"

DISPOSITIVI DI SICUREZZA

Blocco manuale della temperatura a 38°.
Blocco automatico erogazione acqua in caso di mancanza di acqua fredda o acqua calda.
Valvole anti-ritorno e sistema filtrante interno ispezionabili anche dopo il montaggio.

TECHNICAL INFORMATION

HOT WATER TEMPERATURE

Minimum: 48°C
Maximum: 85°C
Recommended: 60°C

PRESSURE

Minimum: 1 bar
Maximum: 5 bar
Recommended: 3 bar

IMPORTANT:

The pressure alimention of hot and cold water have to be the same.
Maximum difference accepted between the two pressures: 1 bar.

FLOW RATE

33 l/m at 2.5 bar

FACTORY SETTING OF THE THERMOSTATIC CARTRIDGE 38°C

Setting test conditions:
Hot water: 60°C/3 bar
Cold water: 15°C/3 bar

CONNECTION DIMENSIONS

Hot and cold water inlets = 3/4" G
Shower and tub outlet = 3/4" G

SAFETY INFORMATION

Manual stop temperature at 38°C.
Automatic stop of the water in case of cold water lack.
Check valves and filters inside.

INFORMATIONS TÉCNIQUES

TEMPERATURE D'ALIMENTATION DE L'EAU CHAUDE

Minimum: 48°C
Maximum: 85°C
Conseillé: 60°C

PRESSION D'ALIMENTATION

Minimum: 1 bar
Maximum: 5 bar
Conseillé: 3 bar

IMPORTANT:

les pressions d'alimentation de l'eau chaude et froide doivent être les mêmes.
La différence au maximum acceptée est de 1 bar.

CAPACITÉ

33 l/min à 2,5 bar

ÉTALLONAGE DE L'USINE DE LA CARTOUCHE THERMOSTATIQUE 38°C

Paramètres d'étallonage
Eau chaude: 60°C/3 bar
Eau Froide: 15°C/3 bar

ATTAQUES

Entrée de l'eau chaude et froide = G 3/4"
Sortie mélangeur douche et bain = G 3/4"

DISPOSITIFS DE SECURITÉ

Bloc manuel de la température à 38 °C.
Bloc automatique de l'eau de distribution en cas de manque de l'eau froide ou de l'eau chaude.
Soupape auto-retour et arrange inspectable intérieur disjoint également après l'assemblage.

TECHNISCHE INFORMATIONEN

TEMPERATUR DES EINZIEHEN DES WARMEN WASSER

Minimum: 48°C
Maximum: 85°C
Fähigkeit: 60°C

ERHÖHUNG DRUCK

Minimum: 1 bar
Maximum: 5 bar
Fähigkeit: 3 bar

WICHTIG:

der Erhöhung Druck des warmen und kalten Wassers muß gleich sein.
Der geltende maximale Unterschied zwischen dem zwei Druck: 1 bar

KAPAZITÄT

33 l/min an 2,5 bar

KALIBRIERUNG DER FABRIK DER THERMOSTATISCHEN KARTUSCHE 38°C

Parameter der Kalibrierung
Warm Wasser: 60°C/3 bar
Kalt Wasser: 15°C/3 bar

ANGRIFF

Eingang warmes und kaltes Wasser = G 3/4"
Ausgang Dusche und Badewanne = G 3/4"

EINHEIT DER DRINGLICHKEIT

Manueller Block des Gewehr-Verteilung Wassers des Temperaturblockes.
Automatischen im kalten Wasser des Mangelfalles oder in den warmen. Wasserventilen der Nichrückgabe und ordnet undichtet inneres.

TERMOSTATICO

Art. 4910

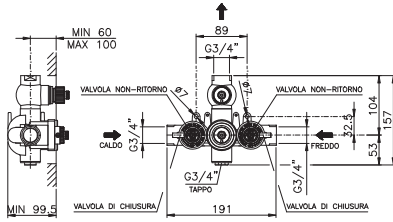

(*) = Disponibile kit di prolunga h. 20 mm. cad.
Available extensions kit h. 20 mm. each

Parte incasso termostatico a incasso da 3/4" con arresto

Built-in type therm. 3/4" with stop cock
Partie int. mélangeur therm. à encastrer 3/4" robinet arrêt
Aufputz Thermostatisch. Misch 3/4" mit Sperventil

Parte int. mezclador termost. empot. 3/4" grifo de cierre
Partie int. misturador termost. encaixe 3/4" torneira de parada
Встраиваемая часть термостата 3/4" с запорным вентилем

Questo articolo deve sempre essere abbinato all'art. 4909 / This article must always be coupled with art. 4909

374,00

INFORMAZIONI TECNICHE - TECHNICAL INFORMATION - INFORMATIONS TÉCNIQUES - TECHNISCHE INFORMATIONEN - PAG. 48

Liberty Art. 4909--16

Parte esterna termostatico a incasso da 3/4" con arresto

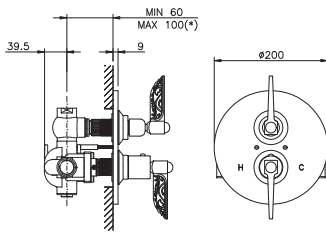

(*) = Disponibile kit di prolunga h. 20 mm. cad.
Available extensions kit h. 20 mm. each

Ext. type built-in therm. 3/4" with stop cock
Partie ext. mélangeur therm. à encastrer 3/4" robinet arrêt
Aufputz Thermostatisch. Unterputz-Misch 3/4" mit Sperventil

Parte ext. mezclador termost. empot. 3/4" grifo de cierre
Base ext. misturador termost. encaixe 3/4" torneira de parada
Наружная часть встр.термостата 3/4" с запорным вентилем

Finitura / Finishing

16

CR NL OG OL OS 402,00

FINITURE SPECIALI *
SPECIAL FINISHING 771,00

GO RG 891,00

Arena Art. 4909--44

Parte esterna termostatico a incasso da 3/4" con arresto

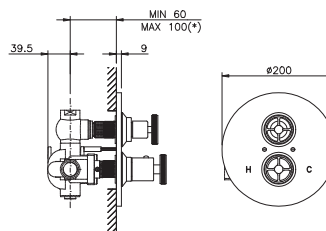

(*) = Disponibile kit di prolunga h. 20 mm. cad.
Available extensions kit h. 20 mm. each

Ext. type built-in therm. 3/4" with stop cock
Partie ext. mélangeur therm. à encastrer 3/4" robinet arrêt
Aufputz Thermostatisch. Unterputz-Misch 3/4" mit Sperventil

Parte ext. mezclador termost. empot. 3/4" grifo de cierre
Base ext. misturador termost. encaixe 3/4" torneira de parada
Наружная часть встр.термостата 3/4" с запорным вентилем

Finitura / Finishing

44

CR NL OG OL OS 240,00

FINITURE SPECIALI *
SPECIAL FINISHING 551,00

GO RG 619,00

Agorà Art. 4909--**

Parte esterna termostatico a incasso da 3/4" con arresto

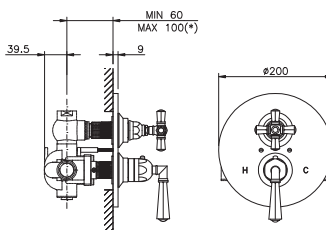

(*) = Disponibile kit di prolunga h. 20 mm. cad.
Available extensions kit h. 20 mm. each

Ext. type built-in therm. 3/4" with stop cock
Partie ext. mélangeur therm. à encastrer 3/4" robinet arrêt
Aufputz Thermostatisch. Unterputz-Misch 3/4" mit Sperventil

Parte ext. mezclador termost. empot. 3/4" grifo de cierre
Base ext. misturador termost. encaixe 3/4" torneira de parada
Наружная часть встр.термостата 3/4" с запорным вентилем

Finitura / Finishing

45IN

05IN

18IN

CR NL OG OL OS 280,00 233,00 209,00

FINITURE SPECIALI *
SPECIAL FINISHING 620,00 515,00 479,00

GO RG 691,00 575,00 539,00

TERMOSTATICO

Art. 4913

Parte incasso termostatico 3/4" senza rubinetto arresto

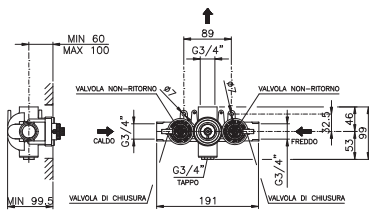

(*) = Disponibile kit di prolunga h. 20 mm. cad.
Available extensions kit h. 20 mm. each

Built-in type therm. 3/4" without stop cock
Partie int. mélangeur therm. à encastrer 3/4" sans robinet arrêt
Aufputz Thermostatisch. Misch 3/4" ohne Sperrventil

Parte interior mezclador termostático sin grifo de cierre
Parte interna misturador termostático sem tomeira de parada
Встраиваемая часть термостата 3/4" без запорного вентиля

Questo articolo deve sempre essere abbinato all'art. 4914 / This article must always be coupled with art. 4914

329,00

INFORMAZIONI TECNICHE - TECHNICAL INFORMATION - INFORMATIONS TÉCNIQUES - TECHNISCHE INFORMATIONEN - PAG. 48

Liberty Art. 4914--16

Parte esterna termostatico a incasso 3/4" senza arresto

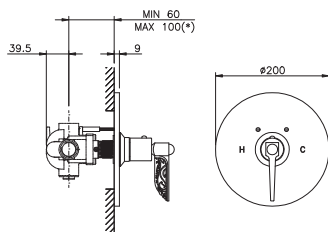

(*) = Disponibile kit di prolunga h. 20 mm. cad.
Available extensions kit h. 20 mm. each

Ext. type built-in therm. 3/4" without stop cock
Partie ext. mélangeur therm. à encastrer 3/4" sans robinet arrêt
Aufputz Thermostatisch. Unterputz-Misch 3/4" ohne Sperrventil

Parte exterior mezclador termostático sin grifo de cierre
Parte externa misturador termostático sem tomeira de parada
Наружная часть встр. термостата 3/4" без запорного вентиля

Finitura / Finishing

16

CR NL OG OL OS 340,00

FINITURE SPECIALI *
SPECIAL FINISHING 649,00

GO RG 752,00

Arena Art. 4914--44

Parte esterna termostatico a incasso 3/4" senza arresto

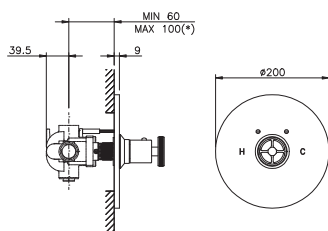

(*) = Disponibile kit di prolunga h. 20 mm. cad.
Available extensions kit h. 20 mm. each

Ext. type built-in therm. 3/4" without stop cock
Partie ext. mélangeur therm. à encastrer 3/4" sans robinet arrêt
Aufputz Thermostatisch. Unterputz-Misch 3/4" ohne Sperrventil

Parte exterior mezclador termostático sin grifo de cierre
Parte externa misturador termostático sem tomeira de parada
Наружная часть встр. термостата 3/4" без запорного вентиля

Finitura / Finishing

44

CR NL OG OL OS 164,00

FINITURE SPECIALI *
SPECIAL FINISHING 417,00

GO RG 469,00

Agorà Art. 4914--05

Parte esterna termostatico a incasso 3/4" senza arresto

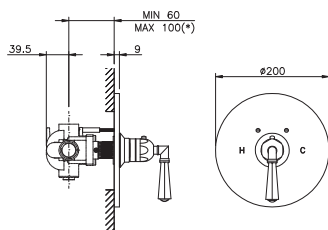

(*) = Disponibile kit di prolunga h. 20 mm. cad.
Available extensions kit h. 20 mm. each

Ext. type built-in therm. 3/4" without stop cock
Partie ext. mélangeur therm. à encastrer 3/4" sans robinet arrêt
Aufputz Thermostatisch. Unterputz-Misch 3/4" ohne Sperrventil

Parte exterior mezclador termostático sin grifo de cierre
Parte externa misturador termostático sem tomeira de parada
Наружная часть встр. термостата 3/4" без запорного вентиля

Finitura / Finishing

METAL

05

CR NL OG OL OS 156,00

FINITURE SPECIALI *
SPECIAL FINISHING 382,00

GO RG 428,00

TERMOSTATICO

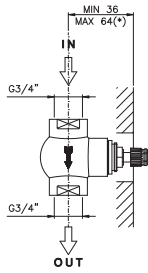

(*) = Disponibile kit di prolunga h. 40 mm. cad.
Available extensions kit h. 40 mm. each

Art. 4911

Built-in part stop cock 3/4"
Partie interieure robinet d'arrêt 3/4"
Unterputzseite Sperrventil 3/4"

Parte incasso rubinetto arresto 3/4"

Parte empotrada de grifo de cierre 3/4"
Base encastrada do passador 3/4"
Встраиваемая часть запорного вентиля 3/4"

Questo articolo deve sempre essere abbinato all'art. 4912 / This article must always be coupled with art. 4912

48,00

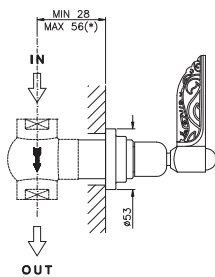

(*) = Disponibile kit di prolunga h. 40 mm. cad.
Available extensions kit h. 40 mm. each

Liberty Art. 4912--16

External part built-in stop cock 3/4"
Partie exterieure robinet d'arrêt 3/4"
Aufputzseite Unterputz-Sperrventil 3/4"

Parte esterna rubinetto arresto incasso 3/4"

Parte esterna grifo de cierre empotrado. 3/4"
Base externa passador de encastrar 3/4"
Наружная часть запорного вентиля 3/4"

Finitura / Finishing

16

CR NL OG OL OS 201,00

FINITURE SPECIALI *
SPECIAL FINISHING 350,00

GO RG 390,00

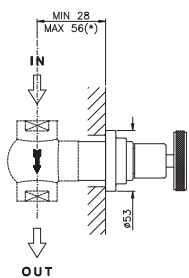

(*) = Disponibile kit di prolunga h. 40 mm. cad.
Available extensions kit h. 40 mm. each

Arena Art. 4912--44

External part built-in stop cock 3/4"
Partie exterieure robinet d'arrêt 3/4"
Aufputzseite Unterputz-Sperrventil 3/4"

Parte esterna rubinetto arresto incasso 3/4"

Parte esterna grifo de cierre empotrado. 3/4"
Base externa passador de encastrar 3/4"
Наружная часть запорного вентиля 3/4"

Finitura / Finishing

44

CR NL OG OL OS 84,00

FINITURE SPECIALI *
SPECIAL FINISHING 135,00

GO RG 149,00

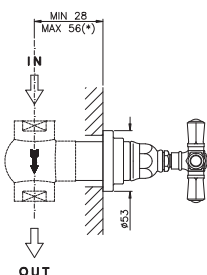

(*) = Disponibile kit di prolunga h. 40 mm. cad.
Available extensions kit h. 40 mm. each

Agorà Art. 4912--**

External part built-in stop cock 3/4"
Partie exterieure robinet d'arrêt 3/4"
Aufputzseite Unterputz-Sperrventil 3/4"

Parte esterna rubinetto arresto incasso 3/4"

Parte esterna grifo de cierre empotrado. 3/4"
Base externa passador de encastrar 3/4"
Наружная часть запорного вентиля 3/4"

Finitura / Finishing

45IN

05IN

18IN

CR NL OG OL OS 96,00 80,00 73,00

FINITURE SPECIALI *
SPECIAL FINISHING 162,00 135,00 117,00

GO RG 180,00 149,00 130,00

accessori bagno

bathroom accessories

■ LIBERTY



■ ARENA



■ AGORÀ



■ MONTE CROCE



Nicolazzi

accessori bagno Liberty



1081 *Appendiabiti*
Clothes-hanger



1082 *Portasalvietta a snodo*
Jointed towel holder



1087 *Portasapone*
Soap holder



1088 *Portabicchiere*
Tumbler holder



1089 *Dosasapone*
Soap dispenser holder



1094 *Portasapone e bicchiere
d'appoggio*
Soap holder with tumbler
holder

accessori bagno

LIBERTY



Nicolazzi



ACCESSORI BAGNO liberty



ACCESSORI BAGNO liberty

Art. 1080

Mensola cm. 60

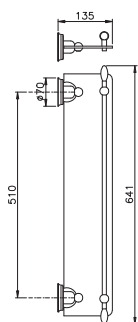

Shelf cm. 60
Étagère cm. 60
Ablage cm. 60

Repisa cm. 60
Prateleira cm. 60
Полочка 60 см

Finitura / Finishing

16

CR NL OG OL OS 285,00

FINITURE SPECIALI *
SPECIAL FINISHING 388,00

GO RG 456,00

Art. 1081

Appendiabiti

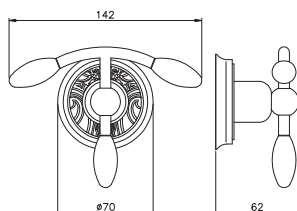

Clothes-hanger
Vêtements-cintre
Kleidung-Aufhänger

Percha
Cabide
Крючок

Finitura / Finishing

16

CR NL OG OL OS 135,00

FINITURE SPECIALI *
SPECIAL FINISHING 184,00

GO RG 210,00

Art. 1082

Portasalvietta a snodo

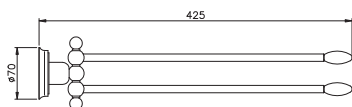

Jointed towel holder
Porte serviette réglable
Handtuchhalter

Toallero articulable
Toalheiro articulado
Держатель полотенец полочка

Finitura / Finishing

16

CR NL OG OL OS 237,00

FINITURE SPECIALI *
SPECIAL FINISHING 332,00

GO RG 380,00

Art. 1083

Portasalvietta cm.35

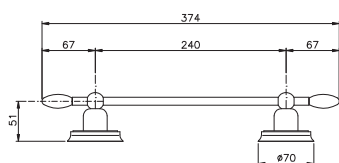

Towel holder cm. 35
Porte serviette cm. 35
Handtuchhalter cm. 35

Toallero cm. 35
Toalheiro cm. 35
Держатель полотенца 35 см

Finitura / Finishing

16

CR NL OG OL OS 213,00

FINITURE SPECIALI *
SPECIAL FINISHING 290,00

GO RG 331,00

Art. 1084

Portasalvietta cm. 50

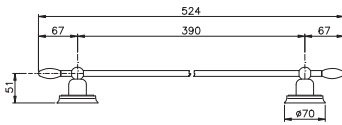
Towel holder cm. 50
Porte serviette cm. 50
Handtuchhalter cm. 50Toallero cm. 50
Toalheiro cm. 50
Держатель полотенца 50 см

Finitura / Finishing

16

CR NL OG OL OS 220,00

FINITURE SPECIALI *
SPECIAL FINISHING 299,00

GO RG 341,00

Art. 1085

Portasalvietta ad anello

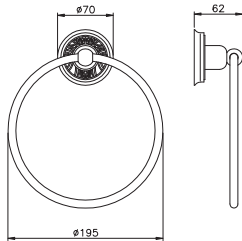
Towel ring
Anneau porte serviette
HandtuchringToallero de anilla
Toalheiro argola
Держатель полотенца кольцо

Finitura / Finishing

16

CR NL OG OL OS 187,00

FINITURE SPECIALI *
SPECIAL FINISHING 262,00

GO RG 300,00

Art. 1086

Portasalvietta cm. 65

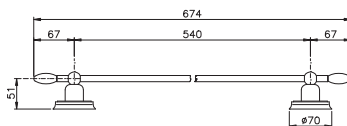
Towel holder cm. 65
Porte serviette cm. 65
Handtuchhalter cm. 65Toallero cm. 65
Toalheiro cm. 65
Держатель полотенца 65 см

Finitura / Finishing

16

CR NL OG OL OS 222,00

FINITURE SPECIALI *
SPECIAL FINISHING 301,00

GO RG 343,00

Art. 1087

Portasapone

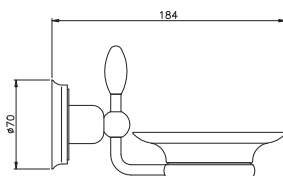
Soap holder
Porte savon
SeifenschaleJabonera
Saboneteira
Мыльница

Finitura / Finishing

16

CR NL OG OL OS 156,00

FINITURE SPECIALI *
SPECIAL FINISHING 212,00

GO RG 243,00

ACCESSORI BAGNO liberty

Art. 1088

Portabicchiere

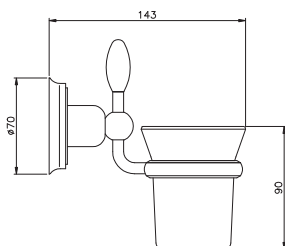

Tumbler holder
Porte verre
Becherhalter

Portavaso
Porta-copos
Стакан

Finitura / Finishing

16

CR NL OG OL OS 157,00

FINITURE SPECIALI *
SPECIAL FINISHING 214,00

GO RG 245,00

Art. 1089

Dosasapone

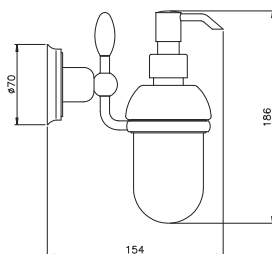

Soap dispenser holder
Porte distributeur de savon
Sefenspenderhalter

Dispensador de jabón
Doseador sabão
Дозатор для жидкого мыла

Finitura / Finishing

16

CR NL OG OL OS 206,00

FINITURE SPECIALI *
SPECIAL FINISHING 281,00

GO RG 321,00

Art. 1090

Portascopino a parete

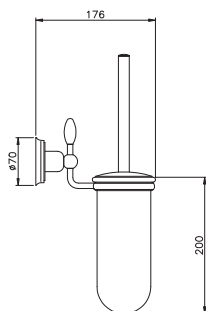

Wall toilet brush holder
Porte balai à mur
Wahdülslengarnitur

Escobillero de pared
Porta-piçaba parede
Туалетный ёршик настенный

Finitura / Finishing

16

CR NL OG OL OS 210,00

FINITURE SPECIALI *
SPECIAL FINISHING 286,00

GO RG 327,00

Art. 1092

Portarotolo

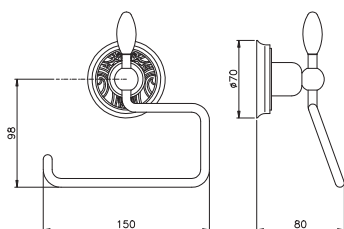

Paper holder
Porte rouleau
Papierrolenhalter

Portarrotolo
Porta-rolos
Бумагодержатель

Finitura / Finishing

16

CR NL OG OL OS 142,00

FINITURE SPECIALI *
SPECIAL FINISHING 193,00

GO RG 221,00

Art. 1093

Portasapone doppio

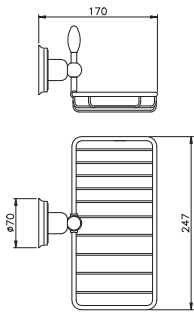

Double soap holder
Porte savon double
Doppelsehenschale

Jabonera doble en rejilla
Saboneteira rede
Бумагодержатель двойной

Finitura / Finishing

16

CR NL OG OL OS 154,00

FINITURE SPECIALI *
SPECIAL FINISHING 216,00

GO RG 247,00

Art. 1094

Portasapone e bicchiere d'appoggio (senza vetri)

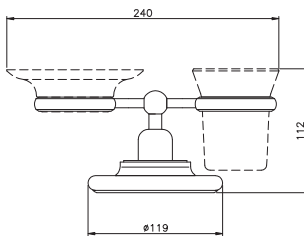

SOLO PER PORTASAPONE E BICCHIERE
ONLY FOR SOAP DISH AND TUMBLER

Soap holder with tumbler holder (without glass)
Porte savon avec porte verre (sans vitrage)
Saifenschale mit becherhalter (ohne glas)

Jaboneira y portavasos de encimera (sin vidrio)
Saboneteira e copo dos dentes (sem vidro)
Держатель мыльницы и стакана настольный (без стекло)

Finitura / Finishing

16

CR NL OG OL OS 210,00

FINITURE SPECIALI *
SPECIAL FINISHING 294,00

GO RG 336,00

Art. 1095

Portasapone doppio ad angolo

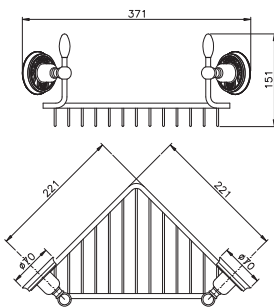

Double soap holder
Porte savon double
Doppelsehenschale

Jabonera doble en rejilla
Saboneteira rede
Бумагодержатель двойной

Finitura / Finishing

16

CR NL OG OL OS 300,00

FINITURE SPECIALI *
SPECIAL FINISHING 420,00

GO RG 480,00

Art. 1097

Portarotolo verticale

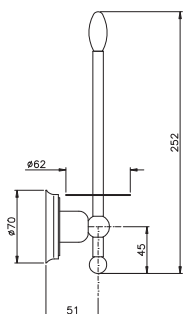

Spare paper holder
Porte rouleau vertical
Senkrechten Papierhalter

Portarrollo verticales
Porta-rolos verticais
Бумагодержатель вертикальный

Finitura / Finishing

16

CR NL OG OL OS 174,00

FINITURE SPECIALI *
SPECIAL FINISHING 244,00

GO RG 279,00

ACCESSORI BAGNO liberty

Art. 1098

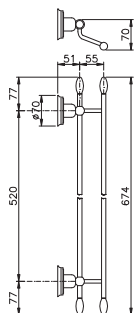
Portasalvietta doppio

Double towel holder
Porte serviette double
Doppel Handtuchhalter

Toallero doble
Toalheiro dobro
Держатель полотенца двойной

Finitura / Finishing

16

CR NL OG OL OS 280,00

FINITURE SPECIALI *
SPECIAL FINISHING 392,00

GO RG 448,00

Art. 1099

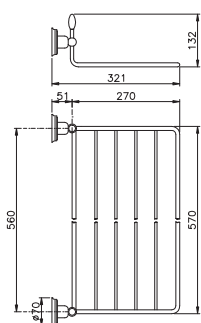
Griglia portasalviette

Towels rack
Grille porte serviette
Gitter Handtuchhalter

En rejilla toallero
Rede toallero
Держатель полотенец полочка

Finitura / Finishing

16

CR NL OG OL OS 408,00

FINITURE SPECIALI *
SPECIAL FINISHING 572,00

GO RG 653,00

accessori bagno

■ ARENA



Nicolazzi

accessori bagno **Arena**



1480 *Mensola cm. 60*
Shelf cm. 60



1481 *Appendiabiti*
Clothes-hanger



1481 M *Appendiabiti*
Clothes-hanger



1482 *Portasalvietta a snodo*
Jointed towel holder



1483 *Portasalvietta cm. 30*
Towel holder cm. 30

1484 *Portasalvietta cm. 45*
Towel holder cm. 45

1486 *Portasalvietta cm. 60*
Towel holder cm. 60



1487 *Portasapone*
Soap holder



1488 *Portabicchiere*
Tumbler holder



1489 *Dosasapone*
Soap dispenser holder



1490 *Portascopino a parete*
Wall toilet brush holder



1492 *Portarotolo*
Paper holder



1493 *Portasapone doppio*
Double soap holder



1495 *Portasapone doppio ad angolo*
Double soap holder



1497 *Portarotolo verticale*
Spare paper holder



1498 *Portasalvietta doppio*
Double towel holder



1499 *Griglia portasalviette*
Towels rack

Art. 1480

Mensola cm. 60

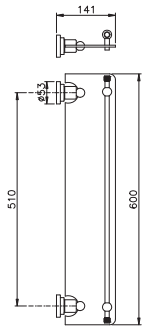
Shelf cm. 60
Étagère cm. 60
Ablage cm. 60Repisa cm. 60
Prateleira cm. 60
Полочка 60 см

Finitura / Finishing

44

CR NL OG OL OS 165,00

FINITURE SPECIALI *
SPECIAL FINISHING 225,00

GO RG 292,00

Art. 1481

Appendiabiti

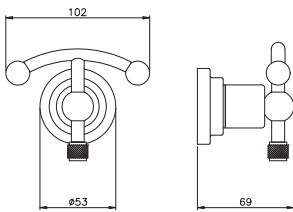
Clothes-hanger
Vêtements-cintre
Kleidung-AufhängerPercha
Cabide
Крючок

Finitura / Finishing

44

CR NL OG OL OS 75,00

FINITURE SPECIALI *
SPECIAL FINISHING 102,00

GO RG 133,00

Art. 1481 M

Appendiabiti

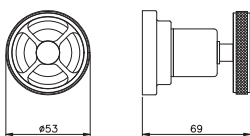
Clothes-hanger
Vêtements-cintre
Kleidung-AufhängerPercha
Cabide
Крючок

Finitura / Finishing

44

CR NL OG OL OS 95,00

FINITURE SPECIALI *
SPECIAL FINISHING 122,00

GO RG 153,00

Art. 1482

Portasalvietta a snodo

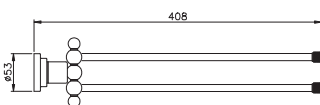
Jointed towel holder
Porte serviette réglable
HandtuchhalterToallero articulado
Toalheiro articulado
Держатель полотенце полочка

Finitura / Finishing

44

CR NL OG OL OS 116,00

FINITURE SPECIALI *
SPECIAL FINISHING 154,00

GO RG 199,00

ACCESSORI BAGNO arena

Art. 1483

Portasalvietta cm.30

Towel holder cm. 30
 Porte serviette cm. 30
 Handtuchhalter cm. 30

Toallero cm. 30
 Toalheiro cm. 30
 Держатель полотенца 30 см

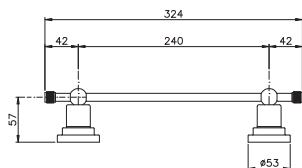

Finitura / Finishing

44

CR NL OG OL OS 108,00

FINITURE SPECIALI *
SPECIAL FINISHING 155,00

GO RG 201,00

Art. 1484

Portasalvietta cm. 45

Towel holder cm. 45
 Porte serviette cm. 45
 Handtuchhalter cm. 45

Toallero cm. 45
 Toalheiro cm. 45
 Держатель полотенца 45 см

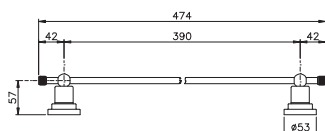

Finitura / Finishing

44

CR NL OG OL OS 117,00

FINITURE SPECIALI *
SPECIAL FINISHING 163,00

GO RG 212,00

Art. 1485

Portasalvietta ad anello

Towel ring
 Anneau porte serviette
 Handtuchring

Toallero de anilla
 Toalheiro argola
 Держатель полотенца кольцо

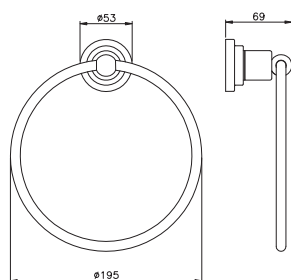

Finitura / Finishing

27

CR NL OG OL OS 86,00

FINITURE SPECIALI *
SPECIAL FINISHING 113,00

GO RG 141,00

Art. 1486

Portasalvietta cm. 60

Towel holder cm. 60
 Porte serviette cm. 60
 Handtuchhalter cm. 60

Toallero cm. 60
 Toalheiro cm. 60
 Держатель полотенца 60 см

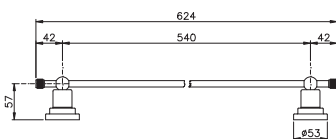

Finitura / Finishing

44

CR NL OG OL OS 117,00

FINITURE SPECIALI *
SPECIAL FINISHING 163,00

GO RG 212,00

Art. 1487

Portasapone

Soap holder
Porte savon
Seifenschale

Jabonera
Saboneteira
Мыльница

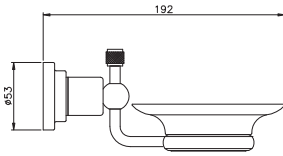

Finitura / Finishing

44

CR NL OG OL OS 81,00

FINITURE SPECIALI *
SPECIAL FINISHING 106,00

GO RG 137,00

Art. 1488

Portabicchiere

Tumbler holder
Porte verre
Becherhalter

Portavaso
Porta-copos
Стакан

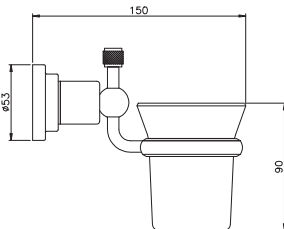

Finitura / Finishing

44

CR NL OG OL OS 82,00

FINITURE SPECIALI *
SPECIAL FINISHING 111,00

GO RG 143,00

Art. 1489

Dosasapone

Soap dispenser holder
Porte distributeur de savon
Seifenspenderhalter

Dispensador de jabón
Doseador sabão
Дозатор для жидкого мыла

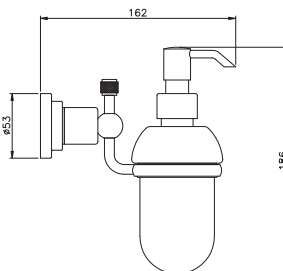

Finitura / Finishing

44

CR NL OG OL OS 121,00

FINITURE SPECIALI *
SPECIAL FINISHING 165,00

GO RG 214,00

Art. 1490

Portascopino a parete

Wall toilet brush holder
Porte balai à mur
Wahdürslengarnitur

Escobillero de pared
Porta-piçaba parede
Туалетный ёршик настенный

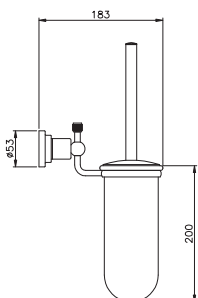

Finitura / Finishing

44

CR NL OG OL OS 124,00

FINITURE SPECIALI *
SPECIAL FINISHING 160,00

GO RG 208,00

ACCESSORI BAGNO arena

Art. 1492

Portarotolo

Paper holder
Porte rouleau
Papierrolenhalter

Portarollo
Porta-rolos
Бумагодержатель

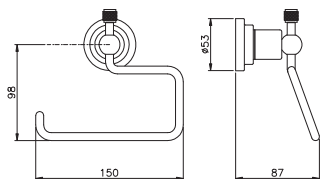

Finitura / Finishing

44

CR NL OG OL OS 81,00

FINITURE SPECIALI *
SPECIAL FINISHING 114,00

GO RG 148,00

Art. 1493

Portasapone doppia

Double soap holder
Porte savon double
Doppelselenschale

Jabonera doble en rejilla
Saboneteira rede
Бумагодержатель двойной

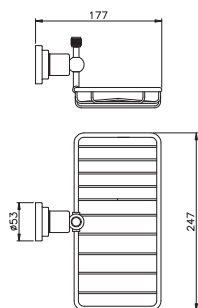

Finitura / Finishing

44

CR NL OG OL OS 98,00

FINITURE SPECIALI *
SPECIAL FINISHING 128,00

GO RG 166,00

Art. 1494

Portasapone e bicchiere d'appoggio (senza vetri)

Soap holder with tumbler holder (without glass)
Porte savon avec porte verre (sans vitrage)
Saifenschale mit becherhalter (ohne glas)

Jaboneira y portavasos de encimera (sin vidrio)
Saboneteira e copo dos dentes (sem vidro)
Держатель мыльницы и стакана настольный (без стекло)

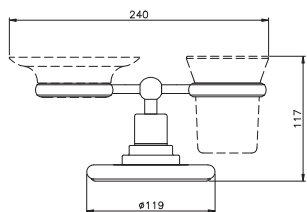

SOLO PER PORTASAPONE E BICCHIERE
ONLY FOR SOAP DISH AND TUMBLER

Finitura / Finishing

27

CR NL OG OL OS 106,00

FINITURE SPECIALI *
SPECIAL FINISHING 146,00

GO RG 189,00

Art. 1495

Portasapone doppio ad angolo

Double soap holder
Porte savon double
Doppelselenschale

Jabonera doble en rejilla
Saboneteira rede
Бумагодержатель двойной

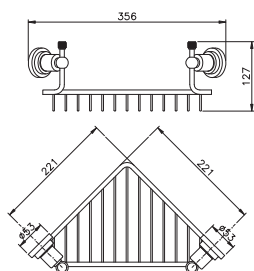

Finitura / Finishing

44

CR NL OG OL OS 227,00

FINITURE SPECIALI *
SPECIAL FINISHING 297,00

GO RG 385,00

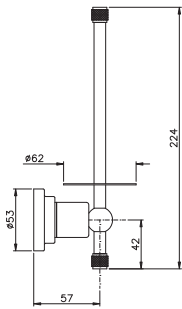
Art. 1497*Portarotolo verticale*

Spare paper holder
Porte rouleau vertical
Senkrechten Papierhalter

Portarollo verticales
Porta-rollos verticais
Бумагодержатель вертикальный

Finitura / Finishing**44**

CR NL OG OL OS 89,00

FINITURE SPECIALI *
SPECIAL FINISHING 124,00

GO RG 161,00

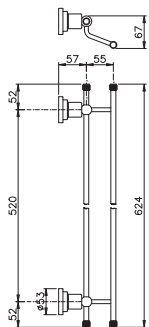
Art. 1498*Portasalvietta doppio*

Double towel holder
Porte serviette double
Doppel Handtuchhalter

Toallero doble
Toalheiro dobro
Держатель полотенца двойной

Finitura / Finishing**44**

CR NL OG OL OS 159,00

FINITURE SPECIALI *
SPECIAL FINISHING 211,00

GO RG 274,00

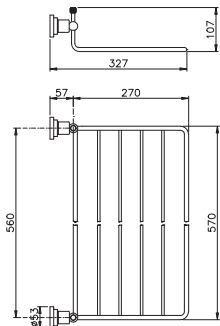
Art. 1499*Griglia portasalviette*

Towels rack
Grille porte serviette
Gitter Handtuchhalter

En rejilla toallero
Rede toallero
Держатель полотенца полочка

Finitura / Finishing**44**

CR NL OG OL OS 266,00

FINITURE SPECIALI *
SPECIAL FINISHING 372,00

GO RG 484,00

accessori bagno Agorà



1480 *Mensola cm. 60*
Shelf cm. 60



1481 *Appendiabiti*
Clothes-hanger



1482 *Portasalvietta a snodo*
Jointed towel holder



1485 *Portasalvietta ad anello*
Towel ring



1483 *Portasalvietta cm. 30*
Towel holder cm. 30



1487 *Portasapone*
Soap holder



1488 *Portabicchiere*
Tumbler holder



1489 *Dosasapone*
Soap dispenser holder

1484 *Portasalvietta cm. 45*
Towel holder cm. 45

1486 *Portasalvietta cm. 60*
Towel holder cm. 60



1490 *Portascopino a parete*
Wall toilet brush holder



1492 *Portarotolo*
Paper holder



1493 *Portasapone doppio*
Double soap holder



1495 *Portasapone doppio ad angolo*
Double soap holder



1497 *Portarotolo verticale*
Spare paper holder



1498 *Portasalvietta doppio*
Double towel holder

accessori bagno

■ AGORÀ



Nicolazzi

ACCESSORI BAGNO agorà

Art. 1480 IN

Mensola cm. 60

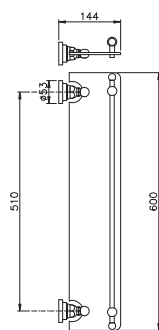

Shelf cm. 60
Étagère cm. 60
Ablage cm. 60

Repisa cm. 60
Prateleira cm. 60
Полочка 60 см

Finitura / Finishing

CR NL OG OL OS 165,00

FINITURE SPECIALI *
SPECIAL FINISHING 225,00

GO RG 292,00

Art. 1481 IN

Appendiabiti

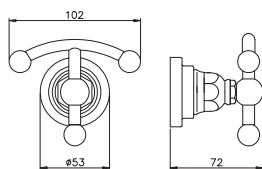

Clothes-hanger
Vêtements-cintre
Kleidung-Aufhänger

Percha
Cabide
Крючок

Finitura / Finishing

CR NL OG OL OS 75,00

FINITURE SPECIALI *
SPECIAL FINISHING 102,00

GO RG 133,00

Art. 1482 IN

Portasalvietta a snodo

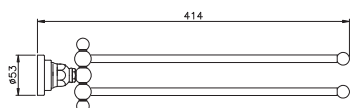

Jointed towel holder
Porte serviette réglable
Handtuchhalter

Toallero articulable
Toalheiro articulado
Держатель полотенец полочка

Finitura / Finishing

CR NL OG OL OS 116,00

FINITURE SPECIALI *
SPECIAL FINISHING 154,00

GO RG 199,00

Art. 1483 IN

Portasalvietta cm.30

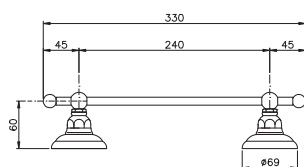

Towel holder cm. 30
Porte serviette cm. 30
Handtuchhalter cm. 30

Toallero cm. 30
Toalheiro cm. 30
Держатель полотенец 30 см

Finitura / Finishing

CR NL OG OL OS 108,00

FINITURE SPECIALI *
SPECIAL FINISHING 155,00

GO RG 201,00

Art. 1484 IN

Portasalvietta cm. 45

Towel holder cm. 45
 Porte serviette cm. 45
 Handtuchhalter cm. 45

Toallero cm. 45
 Toalheiro cm. 45
 Держатель полотенца 45 см

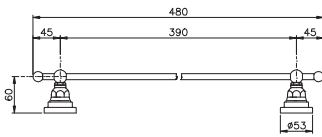

Finitura / Finishing

CR NL OG OL OS	117,00
FINITURE SPECIALI * SPECIAL FINISHING	163,00
GO RG	212,00

Art. 1485 IN

Portasalvietta ad anello

Towel ring
 Anneau porte serviette
 Handtuchring

Toallero de anilla
 Toalheiro argola
 Держатель полотенца кольцо

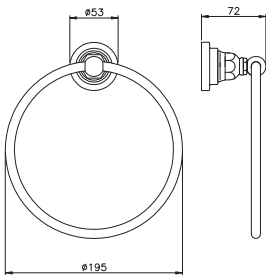

Finitura / Finishing

CR NL OG OL OS	86,00
FINITURE SPECIALI * SPECIAL FINISHING	113,00
GO RG	141,00

Art. 1486 IN

Portasalvietta cm. 60

Towel holder cm. 60
 Porte serviette cm. 60
 Handtuchhalter cm. 60

Toallero cm. 60
 Toalheiro cm. 60
 Держатель полотенца 60 см

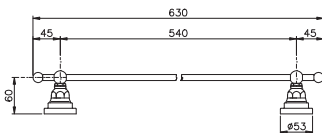

Finitura / Finishing

CR NL OG OL OS	117,00
FINITURE SPECIALI * SPECIAL FINISHING	163,00
GO RG	212,00

Art. 1487 IN

Portasapone

Soap holder
 Porte savon
 Seifenschale

Jabonera
 Saboneteira
 Мыльница

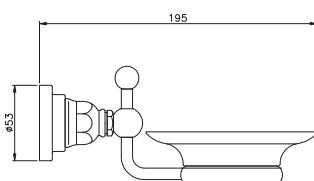

Finitura / Finishing

CR NL OG OL OS	81,00
FINITURE SPECIALI * SPECIAL FINISHING	106,00
GO RG	137,00

ACCESSORI BAGNO agorà

Art. 1488 IN

Portabicchiere

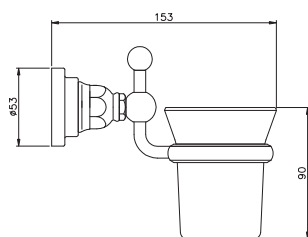

Tumbler holder
Porte verre
Becherhalter

Portavaso
Porta-copos
Стакан

Finitura / Finishing

CR NL OG OL OS 82,00

FINITURE SPECIALI *
SPECIAL FINISHING 111,00

GO RG 143,00

Art. 1489 IN

Dosasapone

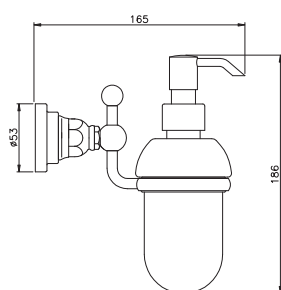

Soap dispenser holder
Porte distributeur de savon
Selpenspenderhalter

Dispensador de jabón
Doseador sabão
Дозатор для жидкого мыла

Finitura / Finishing

CR NL OG OL OS 121,00

FINITURE SPECIALI *
SPECIAL FINISHING 165,00

GO RG 214,00

Art. 1490 IN

Portascopino a parete

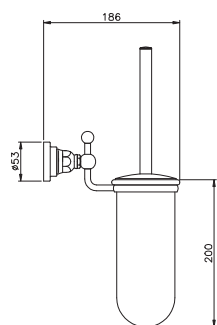

Wall toilet brush holder
Porte balai à mur
Wahdüslengarnitur

Escobillero de pared
Porta-piçaba parede
Туалетный ёршик настенный

Finitura / Finishing

CR NL OG OL OS 124,00

FINITURE SPECIALI *
SPECIAL FINISHING 160,00

GO RG 208,00

Art. 1492 IN

Portarotolo

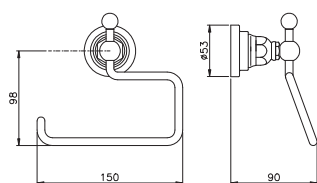

Paper holder
Porte rouleau
Papierrolenhalter

Portarollo
Porta-rolos
Бумагодержатель

Finitura / Finishing

CR NL OG OL OS 81,00

FINITURE SPECIALI *
SPECIAL FINISHING 114,00

GO RG 148,00

Art. 1493 IN

Portasapone doppio

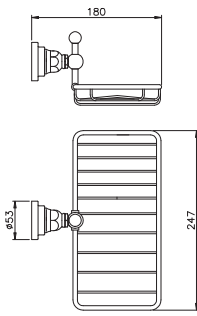

Double soap holder
Porte savon double
Doppelschale

Jabonera doble en rejilla
Saboneteira rede
Бумагодержатель двойной

Finitura / Finishing

CR NL OG OL OS	98,00
FINITURE SPECIALI * SPECIAL FINISHING	128,00
GO RG	166,00

Art. 1494 IN

Portasapone e bicchiere d'appoggio (senza vetri)

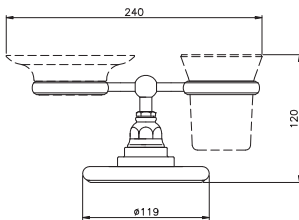

Soap holder with tumbler holder (without glass)
Porte savon avec porte verre (sans vitrage)
Saifenschale mit becherhalter (ohne glas)

Jaboneira y portavasos de encimera (sin vidrio)
Saboneteira e copo dos dentes (sem vidro)
Держатель мыльницы и стакана настольный (без стекло)

Finitura / Finishing

CR NL OG OL OS	106,00
FINITURE SPECIALI * SPECIAL FINISHING	146,00
GO RG	189,00

SOLO PER PORTASAPONE E BICCHIERE
ONLY FOR SOAP DISH AND TUMBLER

Art. 1495 IN

Portasapone doppio ad angolo

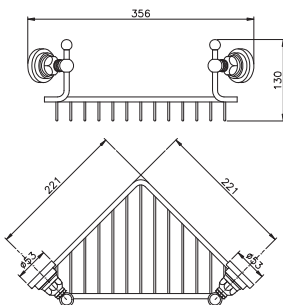

Double soap holder
Porte savon double
Doppelschale

Jabonera doble en rejilla
Saboneteira rede
Бумагодержатель двойной

Finitura / Finishing

CR NL OG OL OS	227,00
FINITURE SPECIALI * SPECIAL FINISHING	297,00
GO RG	385,00

Art. 1497 IN

Portarotolo verticale

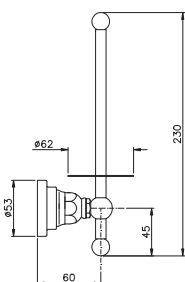

Spare paper holder
Porte rouleau vertical
Senkrechten Papierhalter

Portarollo verticale
Porta-rollos verticais
Бумагодержатель вертикальный

Finitura / Finishing

CR NL OG OL OS	89,00
FINITURE SPECIALI * SPECIAL FINISHING	124,00
GO RG	161,00

ACCESSORI BAGNO agorà

Art. 1498 IN

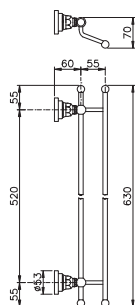
Portasalvietta doppio

Double towel holder
 Porte serviette double
 Doppel Handtuchhalter

Toallero doble
 Toalheiro dobro
 Держатель полотенца двойной

Finitura / Finishing

CR NL OG OL OS	159,00
FINITURE SPECIALI * SPECIAL FINISHING	211,00
GO RG	274,00

Art. 1499 IN

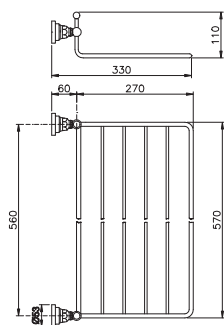
Griglia portasalviette

Towels rack
 Grille porte serviette
 Gitter Handtuchhalter

En rejilla toallero
 Rede toallero
 Держатель полотенца полочка

Finitura / Finishing

CR NL OG OL OS	266,00
FINITURE SPECIALI * SPECIAL FINISHING	372,00
GO RG	484,00

accessori bagno

■ MONTE CROCE



Nicolazzi

accessori bagno Monte Croce



1481 *Appendiabiti*
Clothes-hanger



1483 *Portasalvietta cm. 30*
Towel holder cm. 30



1487 *Portasapone*
Soap holder



1492 *Portarotolo*
Paper holder

1484 *Portasalvietta cm. 45*
Towel holder cm. 45

1486 *Portasalvietta cm. 60*
Towel holder cm. 60



1497 *Portarotolo verticale*
Spare paper holder

Art. 1480

Mensola cm. 60

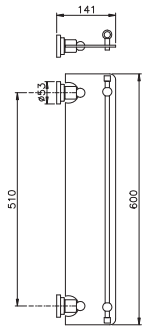

Shelf cm. 60
Étagère cm. 60
Ablage cm. 60

Repisa cm. 60
Prateleira cm. 60
Полочка 60 см

Finitura / Finishing

27

CR NL OG OL OS 165,00

FINITURE SPECIALI *
SPECIAL FINISHING 225,00

GO RG 292,00

Art. 1481

Appendiabiti

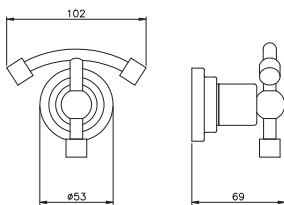

Clothes-hanger
Vêtements-cintre
Kleidung-Aufhänger

Percha
Cabide
Крючок

Finitura / Finishing

27

CR NL OG OL OS 75,00

FINITURE SPECIALI *
SPECIAL FINISHING 102,00

GO RG 133,00

Art. 1482

Portasalvietta a snodo

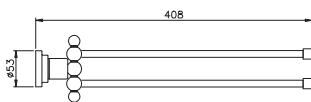

Jointed towel holder
Porte serviette réglable
Handtuchhalter

Toallero articulare
Toalheiro articulado
Держатель полотенец полочка

Finitura / Finishing

27

CR NL OG OL OS 116,00

FINITURE SPECIALI *
SPECIAL FINISHING 154,00

GO RG 199,00

Art. 1483

Portasalvietta cm.30

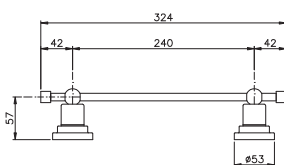

Towel holder cm. 30
Porte serviette cm. 30
Handtuchhalter cm. 30

Toallero cm. 30
Toalheiro cm. 30
Держатель полотенца 30 см

Finitura / Finishing

27

CR NL OG OL OS 108,00

FINITURE SPECIALI *
SPECIAL FINISHING 155,00

GO RG 201,00

ACCESSORI BAGNO monte croce

Art. 1484

Portasalvietta cm. 45

Towel holder cm. 45
 Porte serviette cm. 45
 Handtuchhalter cm. 45

Toallero cm. 45
 Toalheiro cm. 45
 Держатель полотенца 45 см

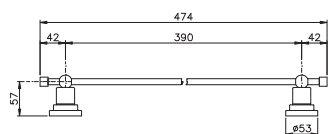

Finitura / Finishing

27

CR NL OG OL OS 117,00

FINITURE SPECIALI *
SPECIAL FINISHING 163,00

GO RG 212,00

Art. 1485

Portasalvietta ad anello

Towel ring
 Anneau porte serviette
 Handtuchring

Toallero de anilla
 Toalheiro argola
 Держатель полотенца кольцо

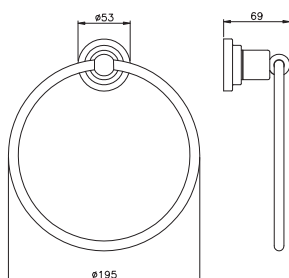

Finitura / Finishing

27

CR NL OG OL OS 86,00

FINITURE SPECIALI *
SPECIAL FINISHING 113,00

GO RG 141,00

Art. 1486

Portasalvietta cm. 60

Towel holder cm. 60
 Porte serviette cm. 60
 Handtuchhalter cm. 60

Toallero cm. 60
 Toalheiro cm. 60
 Держатель полотенца 60 см

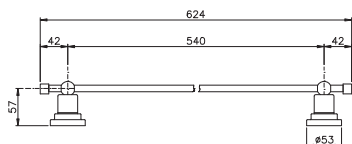

Finitura / Finishing

27

CR NL OG OL OS 117,00

FINITURE SPECIALI *
SPECIAL FINISHING 163,00

GO RG 212,00

Art. 1487

Portasapone

Soap holder
 Porte savon
 Seifenschale

Jabonera
 Saboneteira
 Мыльница

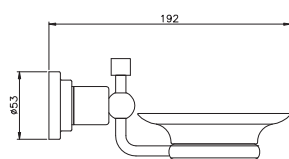

Finitura / Finishing

27

CR NL OG OL OS 81,00

FINITURE SPECIALI *
SPECIAL FINISHING 106,00

GO RG 137,00

Art. 1488

Portabicchiere

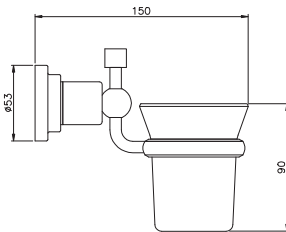
Tumbler holder
Porte verre
BecherhalterPortavaso
Porta-copos
Стакан

Finitura / Finishing

27

CR NL OG OL OS 82,00

FINITURE SPECIALI *
SPECIAL FINISHING 111,00

GO RG 143,00

Art. 1489

Dosasapone

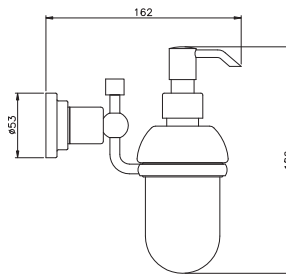
Soap dispenser holder
Porte distributeur de savon
SefenspenderhalterDispensador de jabón
Doseador sabão
Дозатор для жидкого мыла

Finitura / Finishing

27

CR NL OG OL OS 121,00

FINITURE SPECIALI *
SPECIAL FINISHING 165,00

GO RG 214,00

Art. 1490

Portascopino a parete

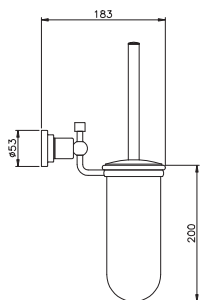
Wall toilet brush holder
Porte balai à mur
WahdürslengarniturEscobillero de pared
Porta-piçaba parede
Туалетный ёршик настенный

Finitura / Finishing

27

CR NL OG OL OS 124,00

FINITURE SPECIALI *
SPECIAL FINISHING 160,00

GO RG 208,00

Art. 1492

Portarotolo

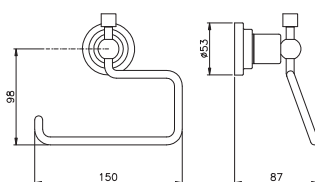
Paper holder
Porte rouleau
PapierrolenhalterPortarollo
Porta-rolos
Бумагодержатель

Finitura / Finishing

27

CR NL OG OL OS 81,00

FINITURE SPECIALI *
SPECIAL FINISHING 114,00

GO RG 148,00

ACCESSORI BAGNO monte croce

Art. 1493

Portasapone doppio

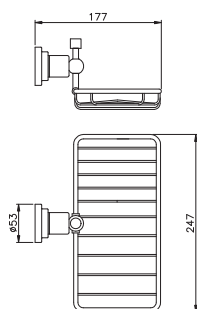

Double soap holder
Porte savon double
Doppelselenschale

Jabonera doble en rejilla
Saboneteira rede
Бумагодержатель двойной

Finitura / Finishing

27

CR NL OG OL OS 98,00

FINITURE SPECIALI *
SPECIAL FINISHING 128,00

GO RG 166,00

Art. 1494

Portasapone e bicchiere d'appoggio (senza vetri)

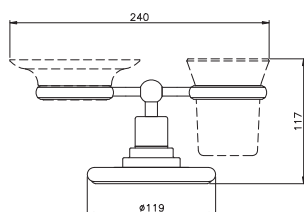

SOLO PER PORTASAPONE E BICCHIERE
ONLY FOR SOAP DISH AND TUMBLER

Soap holder with tumbler holder (without glass)
Porte savon avec porte verre (sans vitrage)
Saifenschale mit becherhalter (ohne glas)

Jaboneira y portavaso de encimera (sin vidrio)
Saboneteira e copo dos dentes (sem vidro)
Держатель мыльницы и стакана настольный (без стекло)

Finitura / Finishing

27

CR NL OG OL OS 106,00

FINITURE SPECIALI *
SPECIAL FINISHING 146,00

GO RG 189,00

Art. 1495

Portasapone doppio ad angolo

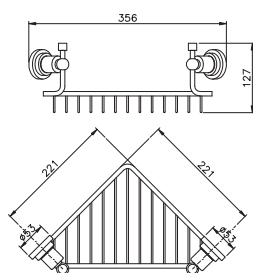

Double soap holder
Porte savon double
Doppelselenschale

Jabonera doble en rejilla
Saboneteira rede
Бумагодержатель двойной

Finitura / Finishing

27

CR NL OG OL OS 227,00

FINITURE SPECIALI *
SPECIAL FINISHING 297,00

GO RG 385,00

Art. 1497

Portarotolo verticale

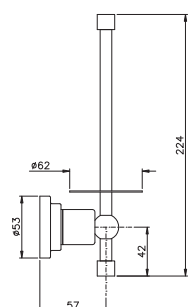

Spare paper holder
Porte rouleau vertical
Senkrechten Papierhalter

Portarrollo verticales
Porta-rolos verticais
Бумагодержатель вертикальный

Finitura / Finishing

27

CR NL OG OL OS 89,00

FINITURE SPECIALI *
SPECIAL FINISHING 124,00

GO RG 161,00

Art. 1498

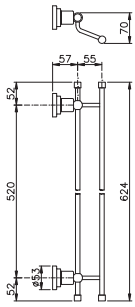
Portasalvietta doppio

Double towel holder
Porte serviette double
Doppel Handtuchhalter

Toallero doble
Toalheiro dobro
Держатель полотенца двойной

Finitura / Finishing

27

CR NL OG OL OS	159,00
FINITURE SPECIALI * SPECIAL FINISHING	211,00
GO RG	274,00

Art. 1499

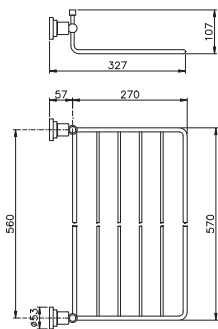
Griglia portasalviette

Towels rack
Grille porte serviette
Gitter Handtuchhalter

En rejilla toallero
Rede toallero
Держатель полотенца полочка

Finitura / Finishing

27

CR NL OG OL OS	266,00
FINITURE SPECIALI * SPECIAL FINISHING	372,00
GO RG	484,00

articoli vari - complementi



5528 *Termoarredo ad Acqua*
Water towel heater



5528 E *Termoarredo elettrico*
Electric towel heater



LIBERTY

5542--16 *Piastra Geberit**
Flush plate



5542 *Piastra Geberit**
Flush plate



IMPERO

3406 *Parte esterna monocomando doccia incasso*
Ext. part of single-lever for built-in shower



IMPERO

3460 *Parte esterna monoc. doccia incasso con deviatore*
Ext. part of single-lever for built-in shower with diverter



3478 *Monocomando lavabo a incasso*
Single Lever wall mounted basin mixer



OLYMPUS

3778 *Monocomando lavabo a incasso*
Single Lever wall mounted basin mixer

articoli vari - complementi



Nicolazzi

ARTICOLI VARI - COMPLEMENTI

Art. 5528

Termoarredo ad Acqua

Water towel heater
 Chauffe-serviettes à eau
 Wasser Handtuchwärmer

Calentador de toallas agua
 Aquecedor de toalhas água
 Полотенцесушители водной

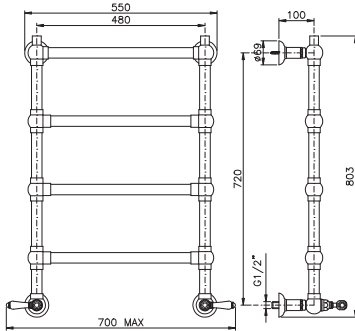

Finitura / Finishing							
	18 70 69						
	07 01 60	78 62 30	79 31	05 44	78A 78B	93 34 32	43
	27 29						
CR NL OG OL OS	1.300,00	1.312,00	1.320,00	1.336,00	1.360,00	1.408,00	1.436,00
FINITURE SPECIALI * SPECIAL FINISHING	1.820,00	1.837,00	1.848,00	1.871,00	1.904,00	1.972,00	2.011,00
GO RG	2.600,00	2.624,00	2.640,00	2.672,00	2.720,00	2.816,00	2.872,00

Finitura / Finishing					
	39 39W			09 090	
	17 15 45	36 36L	16	09C	15C
CR NL OG OL OS	1.480,00	1.566,00	1.723,00	2.760,00	2.914,00
FINITURE SPECIALI * SPECIAL FINISHING	2.072,00	2.193,00	2.413,00	3.864,00	4.080,00
GO RG	2.960,00	3.132,00	3.446,00	5.520,00	5.828,00

Alcuni esempi di maniglie / Some handles example



Art. **5528 E**

Termoarredo elettrico

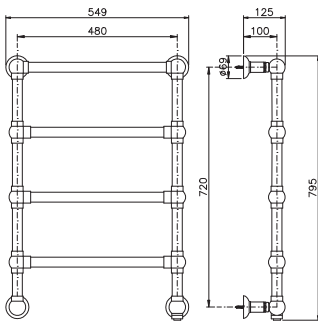

Electric towel heater
 Chauffe-serviettes électrique
 Elektrische Handtuchheizung

Calentador de toallas eléctrico
 Aquecedor eléctrico de toalha
 Электрический нагреватель Полотенце

Finitura / Finishing

CR NL OG OL OS	1.500,00
----------------	----------

FINITURE SPECIALI * SPECIAL FINISHING	2.020,00
--	----------

GO RG	2.800,00
-------	----------

SU RICHIESTA - ON DEMAND

Questo articolo è disponibile anche con maniglie decorative.

This article is also available with decorative handles.

ATTENZIONE - CAUTION

** Sono disponibili per questo articolo differenti attacchi e voltaggi.

Si prega di indicare il paese di destinazione/installazione del prodotto sull'ordine per potervi fornire il prodotto idoneo.

** Are available for this article different attacks and voltages.

Please indicate the country of destination/installation over your order to be able to provide suitable product.

Art. **5542--16**

Piastra scarico sistemi Geberit*

Flush plate
 Plaque de vidage
 Betätigungsplatte

Placa de descarga
 Placa de descargas
 вытяжная пластина

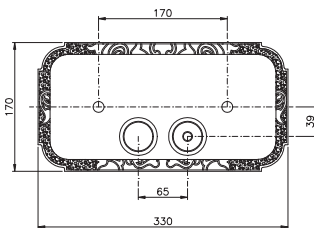

Finitura / Finishing

LIBERTY

16

CR NL OG OL OS	499,00
----------------	--------

FINITURE SPECIALI * SPECIAL FINISHING	670,00
--	--------

GO RG	980,00
-------	--------

ATTENZIONE - CAUTION

** Questo articolo è compatibile con i modelli UNICA, KOMBIFIX, UP300 e UP 320 di GEBERIT.

** This item is suitable for Geberit models UNICA, KOMBIFIX, UP300, UP320.

* Geberit is a register trademark GEBERIT AG

Art. **5542**

Piastra scarico sistemi Geberit*

Flush plate
 Plaque de vidage
 Betätigungsplatte

Placa de descarga
 Placa de descargas
 вытяжная пластина

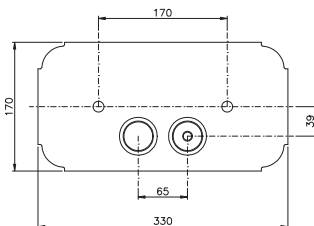

Finitura / Finishing

CR NL OG OL OS	360,00
----------------	--------

FINITURE SPECIALI * SPECIAL FINISHING	471,00
--	--------

GO RG	720,00
-------	--------

ATTENZIONE - CAUTION

** Questo articolo è compatibile con i modelli UNICA, KOMBIFIX, UP300 e UP 320 di GEBERIT.

** This item is suitable for Geberit models UNICA, KOMBIFIX, UP300, UP320.

* Geberit is a register trademark GEBERIT AG

ARTICOLI VARI - COMPLEMENTI

Art. 4006

Corpo monocomando doccia incasso

Single-lever body for built-in shower
Corps mono-commande douche à encaiss
Einhandteil f. eingeb. Dusche

Parte int. monomando ducha empotrado
Corpo monocomando ducha encastrado
Встраиваемая часть встраиваемого для душа

Finitura / Finishing

58,00

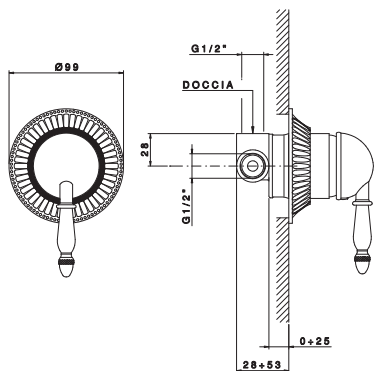

Impero Art. 3406

Parte esterna monocomando doccia incasso

Ext. part of single-lever for built-in shower
Partie ext. mono-commande de douche encaiss
Aussett. des Einhandm. f. eingeb. Dusche

Parte ext. monomando ducha empotrado
Parte ext. monocomando ducha encastrado
Наружная часть встраиваемого смес. для душа

Finitura / Finishing

36LM

CR NL OG OL OS 159,00

FINITURE SPECIALI *
SPECIAL FINISHING 223,00

GO RG 337,00

Art. 4060

Corpo monocomando doccia incasso con deviatore

Single-lever body for built-in shower with diverter
Corps mono-commande douche à encaiss avec aiguillage
Einhandteil f. eingeb. Dusche mit Ablenker

Parte int. monomando ducha empotrado
Corpo monocomando ducha encastrado com desviador
Встраиваемая часть встр. для душа с переключателем

Finitura / Finishing

89,00

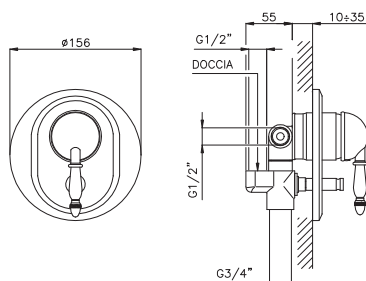

Impero Art. 3460

Parte esterna monoc. doccia incasso con deviatore

Ext. part of single-lever for built-in shower with diverter
Partie ext. douche à encaiss avec aiguillage
Einhandteil f. eingeb. Dusche mit Ablenker

Parte ext. monomando ducha empotrado con desviador
Corpo monocomando ducha encastrado com desviador
Наружная часть встр. для душа с переключателем

Finitura / Finishing

36LM

CR NL OG OL OS 172,00

FINITURE SPECIALI *
SPECIAL FINISHING 242,00

GO RG 357,00

Impero Art. 1232*Monoforo lavabo scarico automatico*

Basin single-hole mixer with automatic pop-up waste
Mélangeur lavabo monotrou avec vidage automatique
Einloch-Waschbecken mit automatischem Ablauf

Monohueco lavabo con desagüe automático
Monofuro lavatorio c/v.d.a.
Двухвентильный с автоматическим сливом для раковины

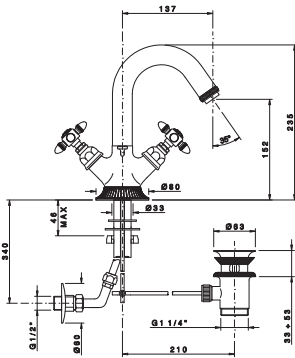

Finitura / Finishing

36

CR NL OG OL OS 618,00

FINITURE SPECIALI *
SPECIAL FINISHING 835,00

GO RG 979,00

Impero Art. 1234*Monoforo bidet scarico automatico*

Bidet single-hole mixer with automatic pop-up waste
Mélangeur bidet monotrou avec vidage automatique
Einloch-Bidet mit automatischem Ablauf

Monohueco lbide con desagüe automático
Monofuro bidet c/v.d.a.
Двухвентильный с автоматическим сливом для биде

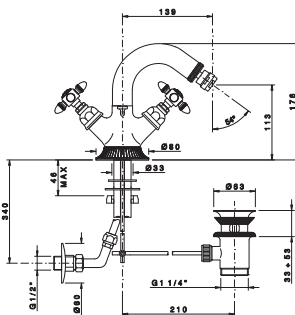

Finitura / Finishing

36

CR NL OG OL OS 618,00

FINITURE SPECIALI *
SPECIAL FINISHING 835,00

GO RG 979,00

Impero Art. C8075*Saliscendi*

Wall sliding rail
Rampe murale
Wandstage

Barra deslizante
Rampa
Штанга

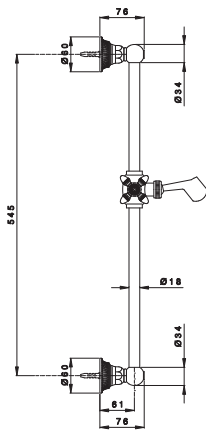

Finitura / Finishing

36

CR NL OG OL OS 360,00

FINITURE SPECIALI *
SPECIAL FINISHING 504,00

GO RG 684,00

Art. C8072*Saliscendi*

Wall sliding rail
Rampe murale
Wandstage

Barra deslizante
Rampa
Штанга

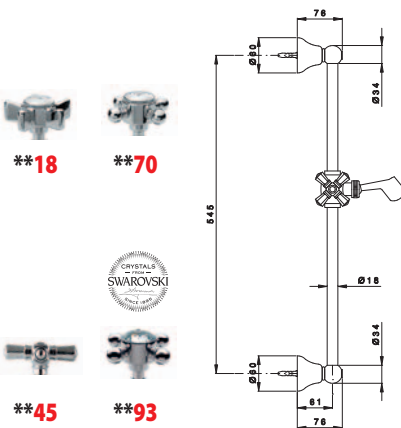

Finitura / Finishing

18**70****45****93**

CR NL OG OL OS 200,00 200,00 260,00 250,00

FINITURE SPECIALI *
SPECIAL FINISHING 280,00 280,00 364,00 350,00

GO RG 380,00 380,00 494,00 475,00

ARTICOLI VARI - COMPLEMENTI

Art. 4006

Corpo monocomando doccia incasso

Single-lever body for built-in shower
Corps mono-commande douche à encaiss
Einhandteil f. eingeb. Dusche

Parte int. monomando ducha empotrado
Corpo monocomando ducha encastrado
Встраиваемая часть встраиваемого для душа

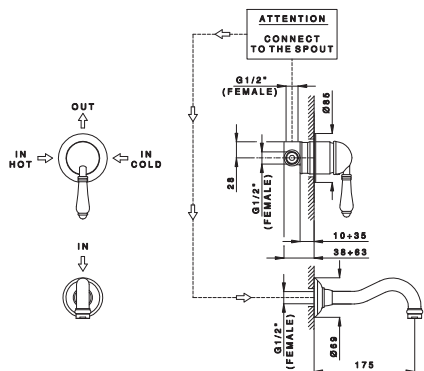

Finitura / Finishing

58,00

Art. 3478

Monocomando lavabo incasso

Single-lever wall mounted basin mixer
Mélangeur lavabo encaiss
Waschtisch eingelassen

Monomando lavabo empotrado
Monomando de lavatorio encastrado
однорычажный для умывальника встраиваемые

INSTALLATION EXAMPLES

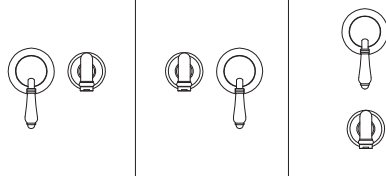

Finitura / Finishing

CRISTALLO	LIBERTY BLACK	DECORATED CERAMICS	EL CAPITAN	P.M. BLANC	P.M. BLANC A	CERAMICA NERA	FOREST
33	40	46	75	76	76A	76B	77

CR NL OG OL OS	238,00	256,00	313,00	216,00	220,00	233,00	233,00	233,00
FINITURE SPECIALI * SPECIAL FINISHING	334,00	360,00	440,00	303,00	309,00	327,00	327,00	327,00
GO RG	476,00	512,00	626,00	432,00	440,00	466,00	466,00	466,00

**33 Cristallo

**40 Liberty Black

**46 Decorated ceramics

**75 El Capitan

**76 P. Mont Blanc

**76A P. Mont Blanc
Ceramica anticata
Antique ceramic

**76B Ceramica nera

**77 Forest



Olympus Art. 3778

Monocomando lavabo incasso

Single-lever wall mounted basin mixer
Mélangeur lavabo encaiss
Waschtisch eingelassen

Monomando lavabo empotrado
Monomando de lavatorio encastrado
однорычажный для умывальника встраиваемые

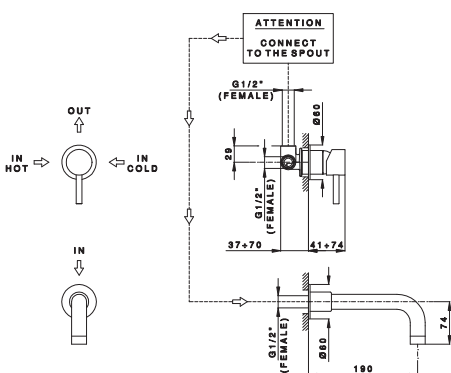

Finitura / Finishing

INSTALLATION EXAMPLES

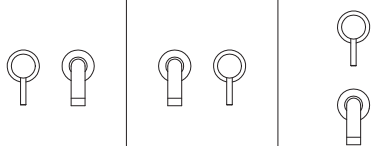

CR NL OG OL OS	255,00
FINITURE SPECIALI * SPECIAL FINISHING	385,00
GO RG	460,00

ARTICOLI VARI - COMPLEMENTI

Art. 5573

Coppia attacchi verticali per vasca esterna

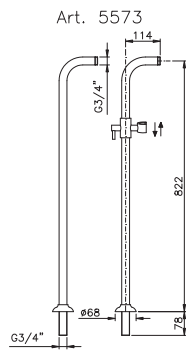

Couple of fixed vertical connection for external bathtub
Couple jonctions verticales pour mélang. bain
Paar bindung für äußere badewannengruppe

Par conexiones verticales para bañera
Par de ataduras verticais para banheira exterior
Пара вертикальных крепежей для ванны

Finitura / Finishing

CR NL OG OL OS	444,00
FINITURE SPECIALI * SPECIAL FINISHING	639,00
GO RG	818,00

Art. 1496B

Portasalviette

Towel holder
Porte serviette
Handtuchhalter

Toallero
Toalheiro
Держатель полотенца

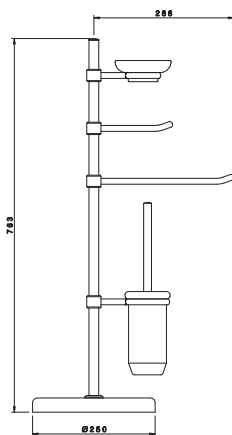

Finitura / Finishing

CR NL OG OL OS	800,00
FINITURE SPECIALI * SPECIAL FINISHING	1.122,00
GO RG	1.426,00

Art. 1496B A

Ceramica anticata

Antique ceramic
Ceramique vieillie
Antike keramik

Ceramica antigua
Ceramica antigua
Керамика антик

Finitura / Finishing

CR NL OG OL OS	829,00
FINITURE SPECIALI * SPECIAL FINISHING	1.161,00
GO RG	1.476,00

Art. 1496B B

Ceramica nera

Black ceramic
Ceramique noir
Schwarzes keramik

Ceramica negra
Ceramica preto
Керамика черная

Finitura / Finishing

CR NL OG OL OS	879,00
FINITURE SPECIALI * SPECIAL FINISHING	1.231,00
GO RG	1.565,00

Art. 1496B D

Ceramica decorata

Decorated ceramic
Décorée en Ceramique
Keramik verziert

Decoración ceramica
Decoração ceramica
Керамика украшенные

Finitura / Finishing

CR NL OG OL OS	1.058,00
FINITURE SPECIALI * SPECIAL FINISHING	1.482,00
GO RG	1.884,00

Art. 1496L

Portasalviette

Towel holder
Porte serviette
Handtuchhalter

Toallero
Toalheiro
Держатель полотенца

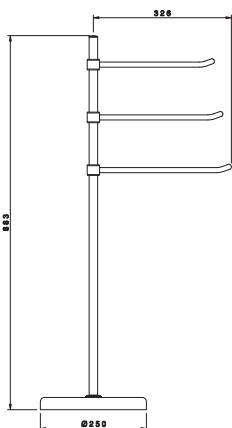

Finitura / Finishing

CR NL OG OL OS	730,00
FINITURE SPECIALI * SPECIAL FINISHING	1.022,00
GO RG	1.300,00

MANIGLIE E LEVE

LIBERTY **C7616**

Finitura / Finishing

CR NL OG OL OS 150,00

FINITURE SPECIALI *
SPECIAL FINISHING 195,00

GO RG 290,00

ARENA **C7644**

Finitura / Finishing

CR NL OG OL OS 43,00

FINITURE SPECIALI *
SPECIAL FINISHING 56,00

GO RG 77,00

AGORA' **C7645IN**

Finitura / Finishing

CR NL OG OL OS 93,00

FINITURE SPECIALI *
SPECIAL FINISHING 129,00

GO RG 197,00

AGORA' **C7605IN**

Finitura / Finishing

CR NL OG OL OS 50,00

FINITURE SPECIALI *
SPECIAL FINISHING 67,00

GO RG 94,00

MANIGLIE E LEVE

AGORA' C7618IN



Finitura / Finishing

CR NL OG OL OS	32,00
FINITURE SPECIALI * SPECIAL FINISHING	42,00
GO RG	58,00

TORRE C7657



Finitura / Finishing

CR NL OG OL OS	28,00
FINITURE SPECIALI * SPECIAL FINISHING	42,00
GO RG	58,00

monocomando ARENA C7648



Finitura / Finishing

CR NL OG OL	28,00
FINITURE SPECIALI * SPECIAL FINISHING	42,00
GO	58,00

monocomando ARENA C7648MD

Finitura / Finishing

	Art. 4106-4178-4196
CR NL OG OL	28,00
FINITURE SPECIALI * SPECIAL FINISHING	42,00
GO	58,00

PULL-DOWN 3420 - C7675P



Finitura / Finishing

CR NL OG OL	50,00
FINITURE SPECIALI * SPECIAL FINISHING	70,00
GO	98,00

MANIGLIE E LEVE - ARTICOLI VARI



Ceramica Anticata
Antique Ceramic

PULL-DOWN 3420 - **C7676P**

Finitura / Finishing

CR NL OG OL 57,00

FINITURE SPECIALI *
SPECIAL FINISHING 80,00

GO 114,00

PULL-DOWN 3420 - **C7676AP**

Ceramica anticata / *Antique ceramic*

Finitura / Finishing

CR NL OG OL 64,00

FINITURE SPECIALI *
SPECIAL FINISHING 91,00

GO 128,00

PULL-DOWN 3420 - **C7677P**

Finitura / Finishing

CR NL OG OL 55,00

FINITURE SPECIALI *
SPECIAL FINISHING 77,00

GO 109,00

PULL-DOWN 3430 - **C7629P**

Finitura / Finishing

CR NL OG OL 55,00

FINITURE SPECIALI *
SPECIAL FINISHING 72,00

GO 105,00

Art. **3009 D 35 P**

Cartuccia monocomando Arena

Cartridge for Arena serie
Cartouche pour série Arena
Einhebel-Kartusche für Arena

Cartucho monomando serie Arena
Cartucho ceramico p/monocomando Arena
Картридж однорычажного Arena

Finitura / Finishing

50,00



condizioni di vendita

sales condition

VALIDITA' DEL CONTRATTO, QUOTAZIONI, CONSEGNA

Con il conferimento dell'ordine si intendono integralmente accettate le seguenti condizioni:

- Gli ordini trasmessi direttamente o tramite rappresentante costituiscono impegno per la ditta NICOLAZZI SpA solo dopo la conferma scritta.
- L'annullamento di un ordine non può essere ottenuto senza il consenso della ditta.
- I termini di consegna si intendono approssimativi e non impegnativi essendo essi vincolati alle disponibilità del momento, la mancata osservanza da parte nostra dei termini di consegna indicati non dà diritto al cliente di annullare l'ordine, differire i pagamenti o reclamare indennizzi, compensi, penali o danni di sorta.
- Salvo diverse intese o ritardi di consegna dovuti a causa di forza maggiore gli ordini cessano di validità 6 mesi dopo la conferma scritta.
- La merce viaggia a rischio e pericolo del destinatario anche quando la spedizione viene effettuata in porto franco, l'azienda declina ogni responsabilità per ritardi, guasti, avarie, rotture, danni, ammanchi causati direttamente o indirettamente dal vettore.
- Le quotazioni di questo catalogo/listino si intendono IVA esclusa e sono espressi in Euro; le quotazioni si intendono per merce resa franco stabilimento di Alzo.
- I prezzi del presente catalogo/listino sono calcolati sugli elementi di costo attuali; nel caso in cui questi dovessero variare saranno modificati in conformità i prezzi.
- La ditta si riserva inoltre il diritto di modificare tecnicamente ed esteticamente la propria produzione.

RECLAMI

- Eventuali reclami riguardanti la quantità o la qualità della merce consegnata debbono essere fatti entro otto giorni dal ricevimento della merce e sempre che la merce si trovi nelle stesse condizioni.
- I materiali ritenuti difettosi potranno essere restituiti solamente previa visione del ns agente ed autorizzazione della ditta. La spedizione dovrà essere effettuata in porto franco.
- La responsabilità della ditta si limita alla sostituzione dei pezzi difettosi e non indennizza eventuali danni diretti o indiretti causati dai nostri materiali.
- Si declina inoltre ogni responsabilità per errata installazione e/o manomissione dei nostri materiali.

PAGAMENTI

- Le modalità di pagamento specificate in fattura si intendono tassative: ogni cambiamento che non sia stato preventivamente ed espressamente pattuito non verrà accettato.
- In caso di ritardato pagamento verranno addebitati gli interessi di mora nella misura stabilita dall'art 5 del D.Leg 231/2002 che decorreranno dal giorno successivo alla scadenza.

RISERVA DI PROPRIETA'

- La merce consegnata rimane di riservato dominio della NICOLAZZI SpA fino all'avvenuto pagamento.

CONTESTAZIONI

- Per eventuali contestazioni è esclusivamente competente il foro di Verbania.

GARANZIA

- Tutti i nostri prodotti stati rigorosamente controllati e collaudati prima di essere posti in vendita e sono coperti da garanzia per un periodo di 6 anni dalla data di acquisto del primo acquirente.
- La garanzia decade qualora:
 1. sia fatto un uso improprio del prodotto
 2. il materiale sia stato modificato o manipolato da persona non autorizzata dalla NICOLAZZI SpA
 3. Il materiale sia stato montato in maniera non corretta
 4. il deterioramento della rubinetteria o dei suoi componenti sia dovuto alla qualità dell'acqua (es. calcare)
- Le superfici non sono coperte da garanzia in quanto subordinate alla cura dell'utente.

VALIDITY OF ORDERS (POS), PRICES, DELIVERY

In reference to your PO we consider accepted following conditions:

- Pos received directly or through agent are an engagement from NICOLAZZI SpA only after written confirmation.
- Pos can be cancelled only in agreement with NICOLAZZI SpA.
- The delivery times are approximate and not binding since they are bound by the availability of the moment. Our failure to observe the terms of delivery specified does not entitle the customer to cancel the order, defer payments or claim any compensation, fees, penalties or damage of any kind.
- If it is not differently indicated orders lose their validity 6 months after confirmation.
- The goods travel at the risk of the recipient when the shipment is prepaid, the company accepts no responsibility for delays, failures, breakdowns, breakages, damage, shortages caused directly or indirectly by the carrier.
- The prices in this catalog / price list are exclusive of VAT and are expressed in Euro; Prices indicated in this documentation are intended Ex work Alzo - EXW.
- Prices in this catalog / price list are calculated on the elements of the current costs; in case these should differ will be amended in accordance with the prices.
- NICOLAZZI SpA has the right to change products in order to improve them technically and aesthetically.

COMPLAIN

- Claims are accepted within 8 days from receiving the goods.
- Returns are accepted only after control of our Area Managers or agents and Company authorization. Return shipment will be done in DDP terms – Delivery Duty Paid - (Carriage Paid).
- Company will replace defective components without refunding direct and in direct damages caused by our goods.
- NICOLAZZI SpA is not responsible for improper installations or non authorized modifications of its goods.

PAYMENTS

- The terms of payment specified in the bill are mandatory. Every change that has not been previously and expressly agreed upon will not be accepted.
- In case of delayed payment will be charged default interest in the amount established by Article 5 of the D.Leg 231/2002 which will begin the day after the deadline.

PROPERTY

- Goods are of NICOLAZZI SpA's property until payment has been settled.

LEGAL ISSUES

- In case of legal needs it is competent "Foro di Verbania".

WARRANTY

- All our products have been rigorously checked and tested before being offered for sale and are warranted for a period of 6 years from the date of the first customer purchase.
- The warranty is void if:
 1. has made improper use of the product
 2. the material has been altered or manipulated by an unauthorized person from NICOLAZZI SpA
 3. the material has been assembled incorrectly
 4. the deterioration of the fitting or its components is due to water quality (eg. limestone).
- The surfaces are not covered by warranty as subject to the care and use of the user.

Your Luxury Taps



Nicolazzi ^{1960 - 2010} **50**

Nicolazzi

Il Vero Lusso Italiano Authentic Italian Luxury

NICOLAZZI produce dal 1960 rubinetti, docce e accessori da bagno dallo stile esclusivo. Oltre al mercato locale esporta dagli Usa alla Russia, dall'Europa all'Australia, dal Sud Africa al Canada il "vero lusso italiano".

L'ALTA QUALITA' è la nostra MISSIONE. NICOLAZZI ha ottenuto da anni le più rigorose certificazioni di prodotto (UPC in Usa e Canada, Watermark e Weis in Australia, e altre ancora) e di processo (ISO 9001). Inoltre NICOLAZZI produce "a mano" ogni singolo prodotto controllandone in pressione il corretto funzionamento. Questo ci permette di fornire sui nostri prodotti una garanzia di 6 anni.

Tutta la produzione è svolta all'interno dello stabilimento di Alzo (Novara) utilizzando esclusivamente componentistica "100% made in Italy". La nostra gamma è disponibile in venti finiture esclusive interamente realizzate da NICOLAZZI. I migliori materiali quali cristalli di Swarovsky, porcellane artigianali toscane, pietre naturali, legni pregiati arricchiscono i nostri rubinetti d'arte.

L'OBIETTIVO per il futuro consiste nel continuare a creare oggetti esclusivi, per essere apprezzati nel mondo da chi è alla ricerca di qualità, design e tradizione tipicamente italiana.



NICOLAZZI produces since 1960 taps, showers and bathroom accessories with an exclusive style. Beside domestic market the "authentic Italian luxury" is exported from USA to Russia, from Europe to Australia, from South Africa to Canada.

HIGH QUALITY is our mission. NICOLAZZI has the most serious product (UPC in Usa and Canada, Watermark and Weis in Australia, and more) and process (ISO 9001) certifications. Every single item is "hand crafted" and quality/pressure tested by NICOLAZZI. All this allows us to give a 6 years warranty on our products.

The whole manufacturing process is made inside our plant in Alzo (Novara) using only "100% made in Italy" components. Our range is available in twenty exclusive colour finishings made by NICOLAZZI. Prestigious materials such as Swarovsky crystals, artisan ceramics from Tuscany, natural stones, exotic woods enrich our taps as "art pieces"

GOAL for the future is to continue creating exclusive objects, to be appreciated in the entire world by people looking for quality, design and typical Italian tradition.



Nicolazzi

B A G N O

Collection Liberty

Il vero stile "Art Nouveau"

The true "Art Nouveau" style



Collection

Impero

Curve dal gusto "Neoclassico"
Rounded shapes of "Neoclassic" scent

Nicolazzi

B A G N O





Collection

Cristallo di Rocca

Naturali trasparenze
Natural translucence

Nicolazzi

B A G N O



Collection

Onice

Bellezza scolpita
Beauty of a sculpture

Nicolazzi

B A G N O





Teide Collection

Il lusso "chic" in ogni dettaglio
"Chic" luxury in any detail

Nicolazzi

B A G N O



Le Pietre

L'espressione massima di ricchezza
Maximum expression of richness

Nicolazzi

B A G N O





Collection

Teide Four

Ieri, oggi e domani...
Yesterday, today and tomorrow...

Nicolazzi B A G N O



Collection

Classica Lusso

Il rustico elegante dai materiali ricercati

Elegant rustic with superior materials

Nicolazzi

B A G N O





Collection

Vincent

Lo stile moderno senza età

Timeless modern style

Nicolazzi

B A G N O

Collection Cinquanta

Il classico confortevole
Classic but comfortable

Nicolazzi

BAGNO - CUCINA





NATURAL
STONES



Nicolazzi

B A G N O

Termostatico e Doccia

C'era una volta...

Once upon a time...

Collection

Cucina

Il design e l'eleganza nell'uso quotidiano
Design and elegance for every day use

Nicolazzi

CUCINA



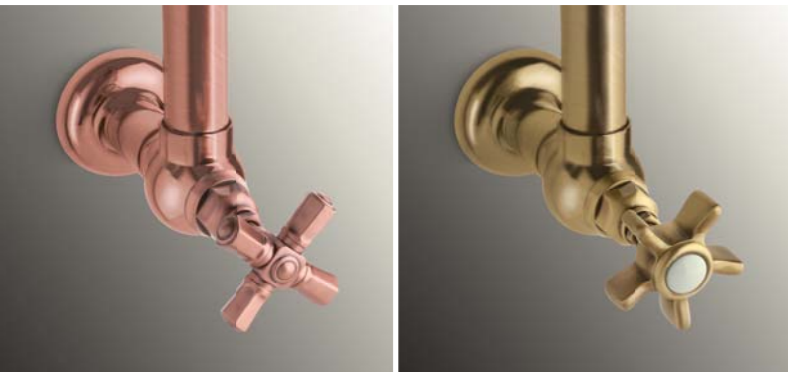

Collection

Arredo Bagno

Preziosi dettagli

Precious details

Nicolazzi

B A G N O



Collection

Classica Lusso

Nicolazzi

ACCESSORI
BAGNO

Materiali pregiati di altri tempi
Fine materials from the past

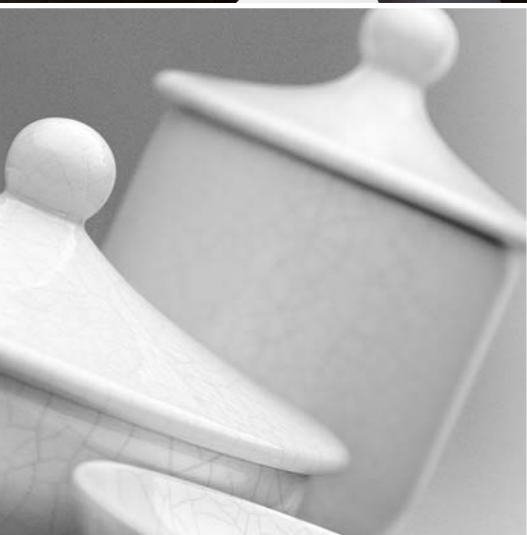

Ecologico

PRODOTTO SENZA PIOMBO E NICHEL
CON OTTONE IN LEGA ANTIDEZINCIFICANTE
LEAD AND NICKEL FREE
BRASS ALLOY WITHOUT ZINC

Nicolazzi S.p.A., da anni attenta ai problemi derivanti dal possibile rilascio di sostanze inquinanti e tossiche dei rubinetti, si è attivata per realizzare prodotti atossici soprattutto per quanto riguarda la cessione di metalli pesanti quali PIOMBO e NICHEL. La rubinetteria Nicolazzi S.p.A. sulla base di strette normative internazionali ha applicato all'intera produzione, che interessa la rubinetteria da cucina e da lavabo, un nuovo speciale ciclo produttivo che elimina la cessione di questi metalli pesanti già all'origine. A tale proposito, Nicolazzi S.p.A. si è attivata per sostituire il trattamento chimico da anni impiegato per la rimozione del PIOMBO dai rubinetti, con l'utilizzo di ottone SENZA PIOMBO di nuova generazione (Pb max. 0.25%) nella propria produzione ecologica. Tale scelta, pur essendo antieconomica per l'azienda, risulta essere un'ulteriore riconferma della filosofia aziendale rivolta a garantire la salute del consumatore soddisfacendo al tempo stesso la legge americana Ab1953, che ad oggi risulta essere la più restrittiva in materia. Tutto questo, abbinato all'impiego di un sistema chimico che inibisce la cessione di NICHEL a contatto con l'acqua potabile ed all'utilizzo di guarnizioni e/o prodotti non metallici atossici, ha permesso a Nicolazzi S.p.A. di testare i propri rubinetti anche secondo la norma americana NSF-61, con una cessione in acqua potabile di PIOMBO inferiore a 11 ppb ($\mu\text{g/l}$) e di NICHEL inferiore a 20 ppb ($\mu\text{g/l}$).

N.B: Le limitazioni attualmente più rappresentative per la cessione di metalli da parte di articoli di rubinetteria nelle acque potabili limitano appunto la cessione del PIOMBO a 11 ppb ($\mu\text{g/l}$) e la cessione di NICHEL a 20 ppb ($\mu\text{g/l}$).

Oltre a certificare che tutti i rubinetti per cucina e lavabo subiscono questo speciale ciclo produttivo ANTI-PIOMBO e NICHEL, i pezzi sono prodotti con ottone in lega ADZ antidezincificante (assenza rilascio di ZINCO), nel rispetto della norma Australiana Watermark e trattati secondo le norme americane NSF-61.

Nicolazzi S.p.A., prima in Italia ad adottare questo procedimento, dimostra in questo modo un'alta sensibilità ai problemi connessi all'ambiente, all'ecologia ed alla salute del consumatore.

La riconoscibilità del prodotto è garantita dal marchio "Ecologico" su ciascun rubinetto.

Nicolazzi S.p.A., very careful with issues concerning release of toxic materials from water taps, has been manufacturing for many years "health friendly" products, mainly not releasing heavy metals such as LEAD and NIKEL into drinking water.

Nicolazzi S.p.A., based on strict international rules, is using a special manufacturing system for all its sinks and washbasin taps to avoid release of heavy metals. To this regard, Nicolazzi S.p.A. has now started a re-organizing process to replace previous "LEAD washing" chemical treatment with the use of new generation LEAD-FREE brass (maximum LEAD 0.25%). This costly Company policy confirms the philosophy to grant consumers' health in respect of the new American norm Ab1953, actually the strictest one in our business. All this, with the chemical treatment to avoid release of NIKEL in drinking water and the use of non-toxic washers and components, allowed Nicolazzi S.p.A. to obtain American norm NSF-61, with a LEAD release less than 11 ppb ($\mu\text{g/l}$) and NIKEL less than 20 ppb ($\mu\text{g/l}$).

NOTE: Actually the strictest limitation for heavy metals release in drinking water for taps are LEAD less than 11 ppb ($\mu\text{g/l}$) and NIKEL less than 20 ppb ($\mu\text{g/l}$).

Beside above procedures against LEAD and NIKEL, our items are made with a special DZR brass (alloy with no release of ZINC) for the Australian Watermark regulation and produced following the NSF-61 American rules.

Nicolazzi S.p.A., the first Italian Company with this manufacturing process, shows a strong sensibility to problems regarding environment, ecology and consumers' health.

Our commitment is granted by the "ECOLOGICO" logo on each tap.

Esempi finiture

Finishings example

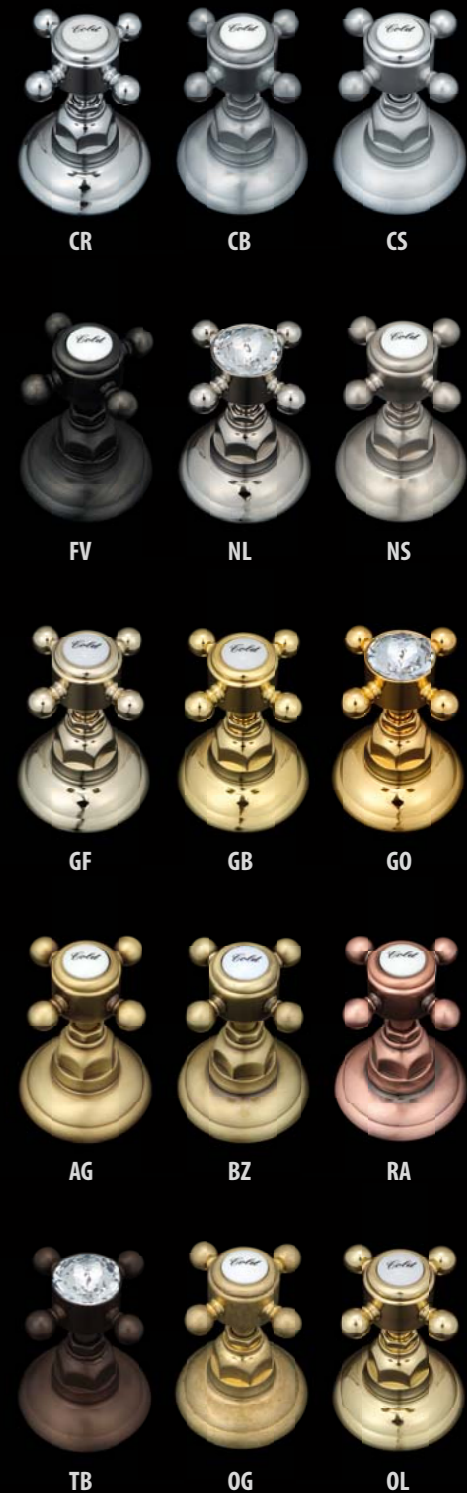

Le finiture sono a titolo indicativo.
Finishings are indicative.
Les finitions sont à titre indicatif.

Nicolazzi

Rubinetteria NICOLAZZI S.p.A.
Via P. Durio, 119
28010 Alzo (NO) Italy
Tel. +39 0322 969672 r.a.
Fax +39 0322 969532 r.a.
info@nicolazzi.it
www.nicolazzi.it