



CATALOG

ENGLISH



Dear readers,

You are now holding the latest VERMOP product catalogue in your hands – 267 pages filled with innovations, further developments and tried and tested solutions around your cleaning process.

But the main topic of this catalogue is not our products – it's you! After all, everything we do is centred around your requirements and your commercial success.

This is why all VERMOP solutions are developed in close collaboration with our customers. Your feedback and requests are often the key factors.

And that is exactly how one of our latest innovations came into existence – and it has the potential to revolutionise cleaning and building management: System ONE, the world's first interlinked system solution for professional cleaning.

What is behind it? System ONE interlinks cleaning tools, vacuum cleaners and floor mopping systems with the Equipe Digital cleaning trolley and a web portal. This enables you to see real time cleaning processes for the first time - and optimise them. (on page 12)

This gives you the opportunity to make use of digitalisation for on site cleaning for the first time.

We have also listened closely to your analog cleaning needs. One of the results: a completely revised and in many aspects optimised Equipe cleaning trolley. (on page 24).

Our suggestion: simply find out yourself how our products and solutions are consistently aligned to your requests and requirements!

Have fun discovering!

Yours, Dirk Salmon

SUMMARY

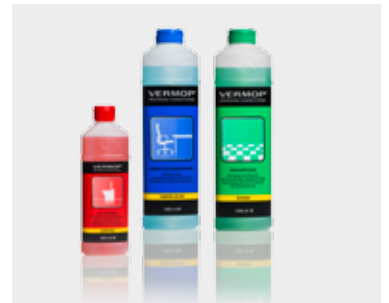

VERMOP | COMPANY

Company	4
Contact	10
System ONe	12

VERMOP | TOOLS

TOOLS | CLEANING TROLLEYS

Overview	20
Equipe	24
Equipe Hotel	54
Shopster	68
Variant	82
Mistral	104
Varietta	108
AquavaVIZ	116
Wet mop trolley	126
Laundry Systems	136

TOOLS | SURFACE CLEANING

Cloths	202
Cloth qualities	204
Glove mop	209
Accessories	210

VERMOP | POWER

Jetvac vacuum cleaner	230
-----------------------	-----

VERMOP | LIQUID

Liquid Standard	248
Liquid Individual	250

TOOLS | FLOOR CLEANING

Overview	148
Mop qualities	152
Methods	156
Twixter System	160
Twix System	162
Sprint System	170
Sprint Plus System	172
Clipper System	178
Scandic System	180
Damp Mop System	184
Aquva System	188
Scandic X System	190
Handles	192
Textile pads	196
Accessories	197

TOOLS | GLASS CLEANING

T-Bar	218
Squeegee LockHead	220
TopLock telescopic handles	224
Glassman safety scraper	226

VERMOP | CONSULTING

Consultancy	242
Coaching	244

VERMOP | MISCELLANEOUS

Index	262
-------	-----



EVEN THE BEST OF THINGS CAN BE IMPROVED

OUR QUALITY STANDARD

Functionality, robustness, longevity. Our solutions have to prove themselves every day in professional use – and thus fulfil the very highest of standards.

This is why we test all products and systems extensively for practical suitability and carrying capacity. In doing so, we always scrutinise the status quo – and continuously develop our entire range even further.

Many of our customers benefit from this enthusiasm for quality, not only regarding our products: As part of our process consulting, we support you with reaching the highest quality standards in all stages of the process chain effectively and efficiently.

- Own research and development centre in Gilching near Munich
- Complete production „made in Germany“ (Wertheim near Frankfurt am Main)
- Fulfilment of strict criteria for production, environmental protection and health and safety
- Certification to ISO 9001 (quality management) and ISO 14001 (environmental management)
- 10 year guarantee for replacement parts

SIMPLY NEARER BY: OUR SERVICE

By your side in person all over Europe: our field sales team supports you on site at all times through competent and customer-orientated consulting.

More about our consultancy and service network on pages 10 and 11.

STRONG BY YOUR SIDE: OUR COMPANY

VERMOP is one of the leading international manufacturers of products, systems and solutions for professional cleaning.

The traditional family-run company is managed in the third generation and can look back on more than 90 years of experience.

The VERMOP headquarters are in Gilching near Munich.





RMOP®
CLEANING SYSTEMS

RMOP
CLEANING SYSTEMS

THINK AHEAD IN ORDER TO BRING OTHERS FORWARD

OUR POWER TO INNOVATE

With curiosity, fun and enthusiasm, we permanently search for new solutions for our customers.

Two claims push us forward in this: how can we fulfil the demand for ergonomic and intuitively useable working equipment even better? And how can we help our customers to differentiate themselves significantly from their competitors?

The result: VERMOP is the innovation leader and research motor in the field of professional cleaning.

The decisive factor: all innovation processes take place in close collaboration with our customers. Together, we put all new developments to intensive practical tests.

- Numerous national and international awards
- Permanent development work with a view to functionality, efficiency, reliability and ergonomics
- Innovative and aesthetic product design
- System ONE : the world's first intelligently interlinked system solution for professional cleaning



Germany's Customer
Champions 2017: Top Result

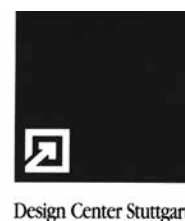
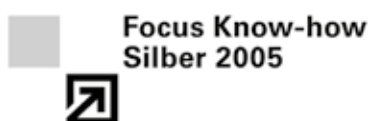



RMOP®
CLEANING SYSTEMS

DESIGNING THE FUTURE TOGETHER

OUR CUSTOMER SUCCESS ORIENTATION

Continuously increasing cost pressures - same high quality standards: This is the stress field our customers operate in.

This is the reason why again and again, we see our most important task in opening up new potentials to increase efficiency for you.

The key criteria: flexibility and sustainability. That is why all our solutions are designed to fit together perfectly and interlock like cogwheels.

This optimum interaction increases profitability not only indirectly: our solutions can also be adapted to future circumstances quickly and cost effective.

- Products which are perfectly coordinated and compatible with one another
- Flexible and modular systems
- Scalable and thus sustainable solutions
- Use of high-quality and long-lasting materials (e.g. stainless steel or fibre-glass reinforced plastic)
- Individual consultation covering your entire value chain

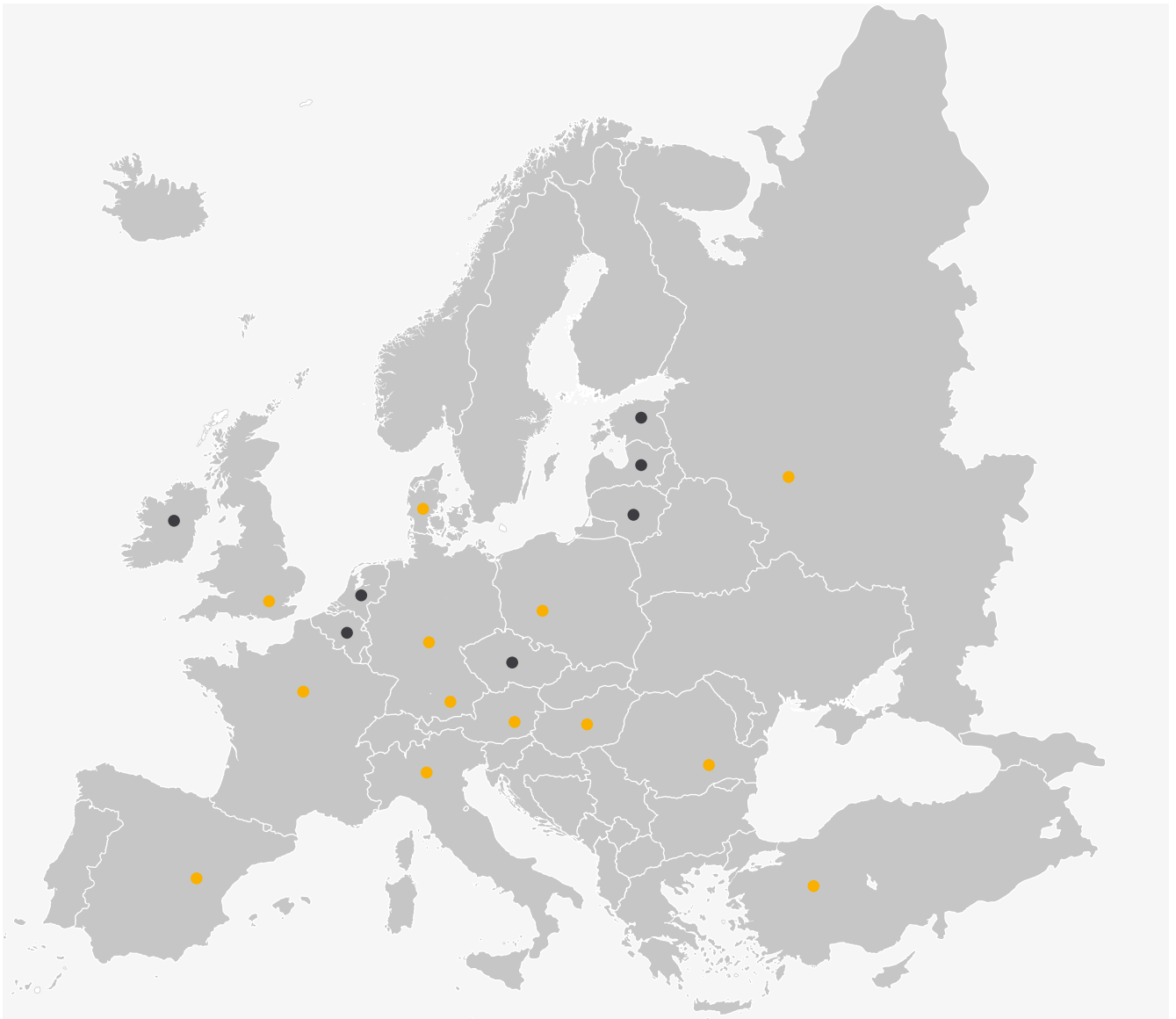

● Subsidiaries

● Field sales staff

COMPANY

CLOSE TO YOU ALL OVER EUROPE

Our experienced consulting and service team is personally available to you all over Europe. We are with you every step of the way, from choosing the cleaning system, to selecting equipment and training your staff.

Simply get in touch with your local VERMOP contact – or our central service telephone. We will be pleased to help you!



Download here:



Are you already familiar with the VERMOP APP?

For all smart phones and tablets, iOS or Android. Download it for free now and try it out!

- Detailed sales representative search
- Access to the complete VERMOP product range
- Current news, videos, product descriptions and lots more



SERVICE-LINE + 49 9342 878 - 800

MONDAY TO THURSDAY: 8.00 AM – 6.00 PM

FRIDAY: 8.00 AM – 3.00 PM

HEADQUARTER VERMOP SALMON GMBH

Zeppelinstr. 24
82205 Gilching
Tel.+ 49 8105 77889 - 0
Fax + 49 8105 77889 - 250
info@vermop.com

VERMOP DEUTSCHLAND GMBH

Kiesweg 4–6
97877 Wertheim
Tel.+ 49 9342 878 - 0
Fax + 49 9342 878 - 173
info@vermop.de

VERMOP ÖSTERREICH GMBH

Weißes Kreuz Straße 5
2103 Langenzersdorf/ Wien
Tel.+ 43 2244 339 99
Fax+ 43 2244 339 99 - 4
info@vermop.at

VERMOP FRANCE SARL

8, allée de l'alouette
93420 Villepinte / Paris
te 1 + 3 3 1 48 63 81 87
fax + 33 1 49 63 27 72
info@vermop.fr

VERMOP POLSKA SP. Z O.O.

ul. Wojkowicka 8a
41-250 Czeladź
Tel. + 48 32 290 54 80
Faks + 48 32 265 60 31
info@vermop.pl

VERMOP ITALIA S.R.L. A SOCIO UNICO

Via Idiomi 3/19
20090 Assago / Milano
Tel. + 3 9 0 2 4 5 70 60 9 3
Fax+ 39 02 45 70 37 87
info@vermop.it

VERMOP DANMARK-APS

Lautruphøj 1–3
2750 Ballerup / København
Tlf. +45 64 43 36 22
Fax +45 64 43 35 22
info@vermop.dk

VERMOP UK LTD.

Unit 3, Moorfield Centre,
Moorfield Rd, Slyfield Ind. Est.,
Guildford GU 1 1 RA
Tel. + 44 1483 506 162
Fax+ 44 1483 506 158
info@vermop.co.uk

VERMOP HUNGÁRIA KFT.

2045 Törökbálint DEPO 1. épület
Postadm:
2046 Törökbálint Pf. 69. / Budapest
Tel. + 36 23 511 7 40
Fax+ 36 23 334 196
info@vermop.hu

VERMOP ESPANA, S.L.U.

c / Francesc Layret, 12 - 14, Nave N° 31,
Polígono Industrial de Sant Ermengol
08630 Abrera / Barcelona
Tel.+ 34 93 770 76 06
Fax+ 34 93 770 76 08
info@vermop.es

000 «BEPМОН PУC»

ул. Садовничэская, 82/2,
115035, г. Москва
Тен + 7 495 665 47 45
факс + 7 495 665 47 45
russia@vermop.com

All orders for our products are subject to our General Terms and Conditions of Business/Sale which are available on our website under www.vermop.com

System Ne

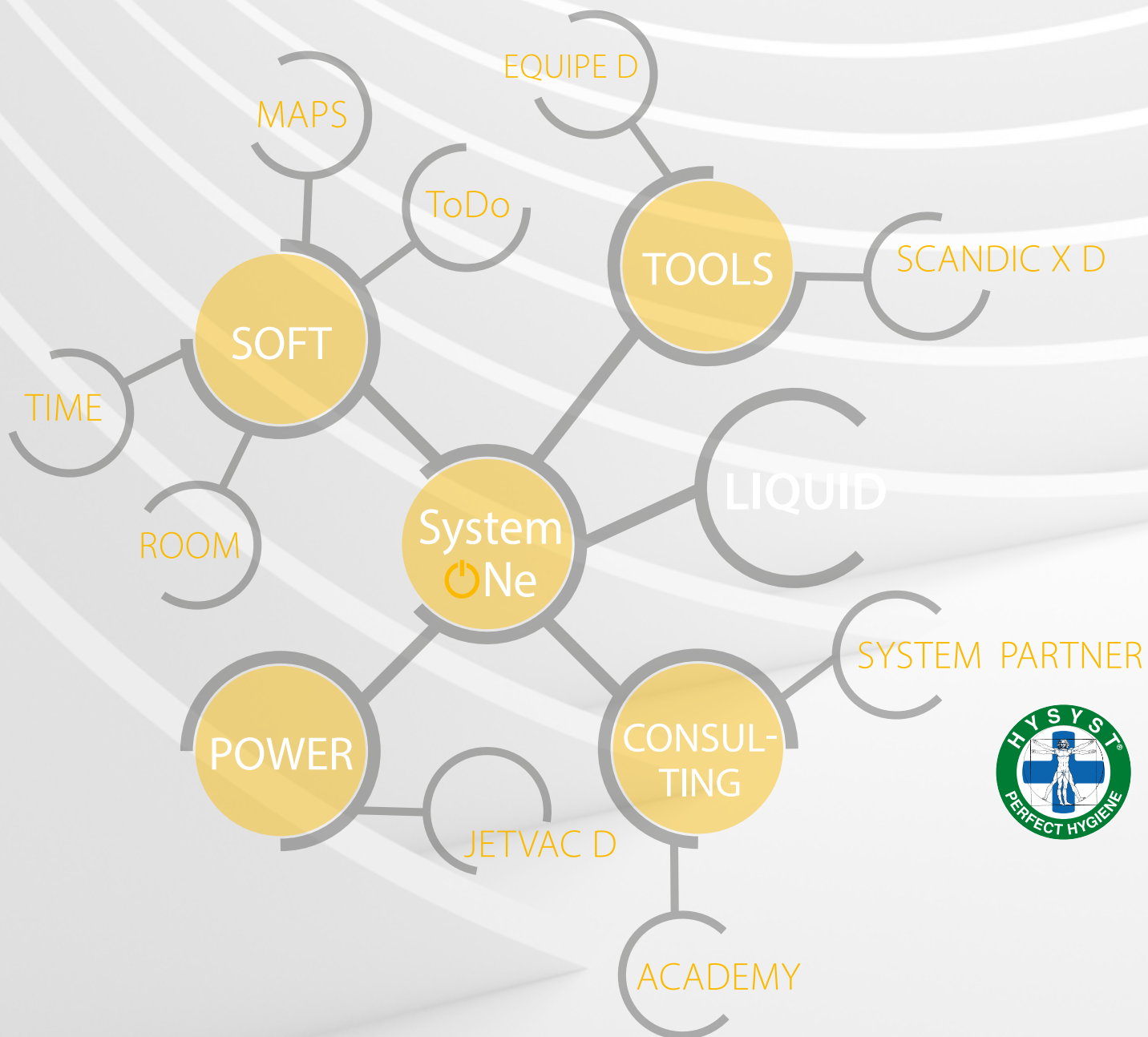

PREMISES CLEANING 4.0 – REAL TIME KEY PERFORMANCE INDICATORS

FROM NOW ON, YOU ARE ALWAYS UP TO DATE WITH WHAT IS
HAPPENING IN YOUR PREMISES

Digitalisation, interconnectedness, internet of things, Industry 4.0: the world is in the middle of a profound change and presently also reaching premises cleaning. VERMOP is now creating the breakthrough: System ONE is the world's first intelligently interlinked system solution for professional premises cleaning.

From now on, you are always up to date with what is happening in your premises!

We connect our cleaning tools with a digital module. This enables the equipment to transmit information about its cleaning activities. Our Equipe Digital cleaning trolley collects all data from your equipment and makes it accessible in a web portal. Likewise, the Equipe Digital itself gives information about where it has been. For the first time, this puts you in a position to compare planned times for an area with actual times. Through this comparison and long term data recording, actual key performance indicators will become visible to you.

This leads to great advantages:

- calculation of key performance indicators
- information about occupancy of premises
- calculation of covered
- continuous process improvement and
- process safety

Our System ONE comprises of interconnected cleaning tools which can be found in the VERMOP TOOLS and VERMOP POWER sections. Purposeful data recording, analysis and provision are done via VERMOP SOFT. With VERMOP CONSULTING, you have a contact partner who will help you to see you through your quality assurance process and is also in a position to carry out checks and controls in this regard.



YOU CAN OBTAIN FURTHER INFORMATION FROM OUR TEAM:

+ 49 9342 878 - 800

MONDAY TO THURSDAY: 8.00 AM – 6.00 PM

FRIDAY: 8.00 AM – 3.00 PM



PROCESS OPTIMISATION WITH SYSTEM

The components of System ONE are a holistic concept based on digital interconnectedness. Different performance components interlink like cogwheels. The objective is always to raise your cleaning processes to a completely new level of efficiency.



VERMOP SOFT: THE SOFTWARE BASIS FOR INTERLINKING YOUR CLEANING DEVICES

VERMOP Soft comprises of complementary software components. These all have the purpose to make your cleaning process more efficient than ever before.

- VERMOP maps** world innovation! Digital recording of buildings via 3D scanners
- VERMOP room** the modern, digital room book
- VERMOP time** the transparent cleaning process
- VERMOP ToDo** your digital cleaning plan



VERMOP TOOLS AND VERMOP POWER: THE DIGITALLY INTERCONNECTED CLEANING MACHINES

A digital module interlinks the VERMOP cleaning systems with the VERMOP Soft software suite. This puts you in a position to generate, analyse and document process data in real time.

- Equipe Digital** the data-collecting cleaning trolley
- Scandic X Digital** the interlinked telescopic bar
- Jetvac Digital** the interlinked vacuum cleaner



VERMOP LIQUID: CLEANING CHEMICALS FOR ALL REQUIREMENTS

Minimum use of product for maximum application variety: the VERMOP Liquid cleaning agents are the ideal supplement in a digitally optimised cleaning process.



VERMOP CONSULTING: PURPOSEFUL SYSTEM AND PROCESS CONSULTING

Our experts as the system provider are by your side with extensive know-how from performance delivery through to quality assurance. Make use of the market leader's competence to launch your digitally interconnected cleaning process smoothly and safely.

CLOUD





EQUIPE DIGITAL

DATA COLLECTORS ON WHEELS

At first glance a cleaning trolley, at second glance your on-site digital centre. With the help of a digital module, the Equipe Digital communicates with the Scandic X Digital und Jetvac Digital cleaning tools. In real time, they provide information about durations and locations of use. (In future, a number of other devices will be added here!)

The Equipe Digital stores the data in a highly secure Cloud. Access to this Cloud – and thus to your process data – is facilitated quickly and easily via our web portal.

You can see in real time whether an object is occupied, which activities have already been carried out and what still has to be done. You can log in as required via your desktop PC or flexibly and on the go via your Smartphone.

Further innovations at a glance:

- digital module for simple recording of cleaning data
- universal holder for disinfectant bottles according to Euro standard
- height-adjustable push-bar handle in a new design
- quiet and easy-to-clean wheels
- immersible 6-litre bucket - optimum storage
- door handle in attractive and functional design
- new disposal unit - can be removed with just one click
- waste management – as flexible as never before
- hinged disposal unit for reduction storage space in one move
- foot pedal for contact less working



YOU CAN OBTAIN FURTHER INFORMATION FROM OUR TEAM:

+ 49 9342 878 - 800

MONDAY TO THURSDAY: 8.00 AM – 6.00 PM

FRIDAY: 8.00 AM – 3.00 PM





VERMOP TOOLS

Economical, flexible, ergonomic, designed down to the smallest detail: VERMOP Tools are much more than just reliable tools for professional premises cleaning. Developed in close cooperation with our customers, they raise the effectiveness and efficiency of your processes to a new level.

For example the Equipe cleaning trolley: the compact and versatile cleaning headquarters on wheels can be custom designed to suit your specific requirements. Or VERMOP Scandic X: various different cleaning tasks can be undertaken using a single flexible system. Or the efficient Twixter double-sided mop system – for highly efficient wet and dry cleaning with only one mop.

Discover a number of further examples of how you can solve your cleaning tasks even more productively thanks to our innovations.

TOOLS | CLEANING TROLLEYS

TOOLS | FLOOR CLEANING

TOOLS | SURFACE CLEANING

TOOLS | GLASS CLEANING



 TOOLS

CLEANING TROLLEYS

THE FUNCTIONAL TROLLEY

VERMOP cleaning trolleys offer numerous functions and advantages for daily use.

Simply configure your individual cleaning trolley and benefit from our high-quality range for everyday use.

EQUIPE

- The revolutionary space miracle, up to 50 % more loading capacity than conventional trolleys
- Maximum configuration flexibility
- Appearance to suit your needs – with or without covering panel
- High level of safety due to lockable elements
- Ergonomic due to height-adjustable functions
- All components are made of 100 % recyclable plastic

Combinable cleaning methods



Twixter-Press • F1 flat wringer • Vertical wringer VK 4 • Des tub • Pre-Wash • Dry cleaning • Spray method • Pour method



SHOPSTER

- Extremely compact cleaning trolley with the footprint of a double bucket trolley
- Maximum configuration flexibility
- Can be combined with all floor-cleaning methods
- High level of safety due to lockable elements
- All components are made of 100 % recyclable plastic

Combinable cleaning methods



Twix-Press • Vertical wringer VK 4 • Des tub • Pre-Wash • Dry cleaning • Spray method • Pour method



VARIANT



- The long-lasting classic trolley
- Chrome coated version, available with collapsible holding frame for space-saving storage
- Also available as high-quality stainless steel version

VARIETTA



- The small compact models: small trolleys, great variety

AQUVAVIZ



- Small and practical: Plastic base combined with slot-in stainless steel bars
- Economical and low cost
- Small dimensions for small cleaning units

MISTRAL



- Economical solution
- Compact and stable: Stainless steel and aluminum coated

WET MOP TROLLEYS

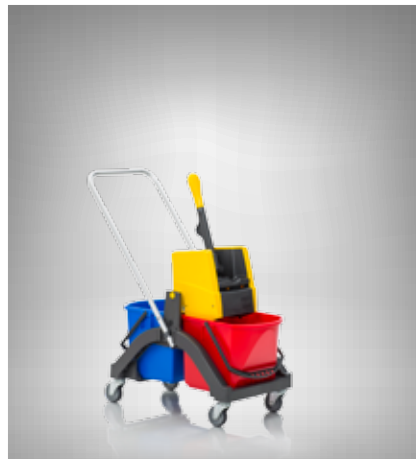

- Classic double trolley for cleaning in heavily soiled areas
- Small and manouverable: Plastic base with stainless steel handle

PAPER- AND DISPOSAL TROLLEY



- Long-lasting and sturdy
- For large quantities of waste
- Various versions available



 TOOLS

CLEANING TROLLEYS INDIVIDUAL

INDIVIDUAL DESIGN

In addition to a tidy appearance, the covering panels ensure greater safety when transporting cleaning materials. You design the Equipe to your taste and to suit the area of use. The covering panels can be freely combined with coloured door handles and shock protection. With your logo or your pictures on the covering panels you can give the Equipe an even more individual look. The VERMOP Design Team would be pleased to advise you.



 TOOLS
EQUIPE

CLEANING TROLLEYS

Equipe 2018 – the cleaning trolley which has been successful all over Europe is now even better! Benefit from the new functionalities and discover the modern premium design.

Equipe is always customised to exactly match your needs. The single modules are configured individually. From the modular kit system, you choose different sizes of base plates and combine them via plug & play.



The Equipe cleaning trolley is more than just a cleaning trolley – it is a rolling, ergonomic cleaning centre. The smooth surface construction and the drawer-shaped arrangement of the containers make optimum use of space. This means, you have everything at hand – unnecessary trips to get things is a thing of the past.

We would be pleased to support you in putting together the Equipe cleaning trolley best suited to your requirements.

Q AT A GLANCE

- **Modular cleaning trolley**
Maximum configuration flexibility
- **Highest loading capacity**
Up to 50 % greater loading capacity than conventional cleaning trolleys
- **Professional appearance**
Covering panels and integration of corporate design to customer requests
- **Height-adjustable functions**
Ergonomic use with simply and quickly adaptable functions
- **All floor cleaning systems**
Can be combined with all VERMOP floor cleaning systems
- **Colour coding**
Choice of colours for many parts
- **Equipe 2018**
New functions, modern design

AREAS OF APPLICATION

- Security sensitive areas
- Premium premises
- Sanitary facilities
- Disposal
- Supply

SITE



Hospital / Nursing home • Large areas (Airport, Exhibition) • Office / Administration • School / Nursery

METHODS



Twixter-Press • F1 flat wringer • Vertical wringer • VK 4 • Des tub • Pre-Wash • Dry cleaning • Spray method • Pour method





Equipe Base I

Basic trolley for standard cleaning use. Extendable to accommodate a floor cleaning module and colour-coded surface buckets, it offers enough space for cleaning textiles and supplies.

Description	code
Equipe Base I	1663311

Dimensions: 83 x 57 x 109 cm (W x D x H)

Set includes:

Description	code
4x Wheel, 100 mm	16910
2x bar incl. screws	16215
6x crossbeam, anthracite	1652706
2x stabilizer flat, anthracite	1654206
6x cover flat, anthracite	1645406
2x box 5 l, anthracite	1646106
1x box 15 l, anthracite	1648006
1x shock protection plus set Equipe (4 pcs), yellow	1656505
1x base frame L, without wheels, without bars	1621098



Equipe Base II

The Equipe Base II trolley is designed for efficient wet cleaning of large floor areas. Combined with the Twixter floor cleaning system and the double-sided Twixter mop, this solution guarantees a time saving over conventional mop systems as well as greater surface coverage. The Twixter wringer makes it possible to wring out the cover without further hand contact and without removing the mop from the holder. At the softpoint, the cover is automatically wrung out by the wringer without pressure on the lever. While this is happening, other cleaning tasks can be carried out or the trolley moved to the next room. In addition, the trolley offers colour-coded buckets for surface cleaning, storage space for cleaning utensils and supplies and a disposal unit.

Description	code
Equipe Base II	1663312
Dimensions: 95 x 62 x 112 cm (W x D x H)	

Set includes:

Description	code
4x Wheel, 100 mm	16910
2x bar incl. screws	16215
4x crossbeam, anthracite	1652706
1x stabilizer flat, anthracite	1654206
3x cover flat, anthracite	1645406
1x cover flat with Twixter equipment holder, anthracite	1641406
2x box 5 l, anthracite	1646106
1x bucket 8 l, blue	1642801
1x bucket 8 l, red	1642802
1x bucket 8 l, yellow	1642805
1x Twixter wringer, yellow	1871805
1x tub 20 l, yellow	1872405
1x tub 20 l, anthracite	1872306
1x unit for wringer Twixter, stainless steel	16343
1x box 15 l, anthracite	1648006
1x shock protection plus set Equipe (4 pcs), yellow	1656505
2x shock protection plus Equipe (1 pcs), yellow	1656705
1x base frame L, without wheels, without bars	1621098
1x stabiliser with 6 hooks and 3 equipment holders, anthracite	1659406

Equipe Base III

Basic trolley for standard office cleaning applications. Alongside colour-coded surface buckets and an integrated disposal unit, it provides sufficient space for cleaning textiles and consumables. The particular segmenting and distinguishing of the frames by colours makes waste management flexible.

Description	code
Equipe Base III	1663313
Dimensions: 104 x 56 x 109 cm (W x D x H)	

Set includes:

Description	code
4x Wheel, 100 mm	16910
2x bar incl. screws	16215
4x crossbeam, anthracite	1652706
1x stabilizer flat, anthracite	1654206
3x cover flat, anthracite	1645406
1x box 5 l, anthracite	1646106
1x bucket 8 l, blue	1642801
1x bucket 8 l, red	1642802
1x bucket 8 l, yellow	1642805
1x box 15 l, anthracite	1648006
1x shock protection plus set Equipe (4 pcs), yellow	1656505
1x Stabiliser short plus HR 2x40 l	16397
1x folding frame 1x40 l, yellow	1639005
1x folding frame 1x40 l, red	1639002
1x base frame L for foot pedal, without wheels, without bars	1621198
1x holding frame Plus F with push bar handle, yellow	162891205
1x stabiliser with 6 hooks and 3 equipment holders, anthracite	1659406
1x folding frame 1x70 l, blue	1638901



Equipe Base IV

The Equipe Base IV is a distinctly economical cleaning trolley - specifically using the pre-wash method - both for single-phased disinfection and also for general cleaning. The enclosed box system guarantees hygienic transport of the mop cover to the area of use and particularly efficient cleaning. The mops are prepared centrally and attached to the holder directly from the box at the area of use without having to bend down and without skin contact. This saves time. In addition, the trolley provides colour-coded buckets for surface cleaning, storage space for cleaning utensils and consumables and also a disposal unit.

Description	code
Equipe Base IV	1663314
Dimensions: 98 x 56 x 112 cm (W x D x H)	

Set includes:

Description	code
4x Wheel, 100 mm	16910
2x bar incl. screws	16215
3x crossbeam, anthracite	1652706
2x stabilizer flat, anthracite	1654206
3x cover flat, anthracite	1645406
2x box 5 l, anthracite	1646106
2x lid with sealing for boxes 5 / 15 / 35 l, transparent with coloured imprint, transparent	1648109
1x bucket 8 l, blue	1642801
1x bucket 8 l, red	1642802
1x bucket 8 l, yellow	1642805
3x box 15 l, anthracite	1648006
1x shock protection plus set Equipe (4 pcs), yellow	1656505
1x double driving handle with handle holder, yellow	1659605
1x base frame L, without wheels, without bars	1621098

Equipe Advanced I

Trolley for premises with high requirements in terms of cleaning and waste disposal. Expanded to include a floor cleaning module and colour-coded surface bucket, it offers everything for extensive cleaning and disposal tasks. The fold-away disposal unit allows simple space reduction for storage.

Description	code
Equipe Advanced I	1664311
Dimensions: 141 x 56 x 112 cm (W x D x H)	

Set includes:

Description	code
4x Wheel, 125 mm	16922
2x bar incl. screws	16215
6x crossbeam, anthracite	1652706
2x stabilizer flat, anthracite	1654206
5x cover flat, anthracite	1645406
2x box 5 l, anthracite	1646106
2x box 15 l, anthracite	1648006
1x shock protection plus set Equipe (4 pcs), yellow	1656505
1x Extension unit Plus KL F, 125 mm, yellow	162811205
1x Stabiliser short plus HR 2x40 l	16397
1x 1x40 l, yellow	1639005
1x folding frame 1x40 l, red	1639002
1x base frame L, without wheels, without bars	1621098
1x folding frame 1x70 l, blue	1638901



Equipe Advanced II

The Equipe Advanced II shows its strengths in premises with medium to high levels of soiling and heavy foot traffic. With the integrated Sprint floor cleaning system, it is the ideal cleaning trolley for wet cleaning using the two-bucket method. The VK 4 wringer allows the Sprint mop to be wrung out to the desired degree of moistening. At the maximum pressure point (softpoint), the cover is wrung out automatically without pressure on the lever. In addition, the trolley offers colour-coded buckets for surface cleaning and storage space for cleaning equipment and supplies. The additional mop rest, combined with the equipment holder, offers perfect storage for the handles and other utensils. The fold-away disposal unit allows simple space reduction for storage.

Description	code
Equipe Advanced II	1664312

Dimensions: 141 x 62 x 114 cm (W x D x H)

Set includes:

Description	code
4x Wheel, 125 mm	16922
2x bar incl. screws	16215
4x crossbeam, anthracite	1652706
1x stabilizer flat, anthracite	1654206
2x cover flat, anthracite	1645406
1x cover flat with equipment holder, anthracite	1641506
2x box 5 l, anthracite	1646106
1x bucket 17 l, blue	1641701
1x bucket 17 l, red	1641702
1x bucket 8 l, blue	1642801
1x bucket 8 l, red	1642802
1x bucket 8 l, yellow	1642805
1x vertical wringer VK 4, red	1871402
1x unit for wringer VK 4, stainless steel	16340
1x shock protection plus set Equipe (4 pcs), yellow	1656505
1x Extension unit Plus KL F, 125 mm, yellow	162811205
1x mop rest plus, yellow	1631205
1x Stabiliser short plus HR 2x40 l	16397
1x folding frame 1x40 l, yellow	1639005
1x folding frame 1x40 l, red	1639002
1x base frame L, without wheels, without bars	1621098
1x stabiliser with 6 hooks and 3 equipment holders, anthracite	1659406
1x folding frame 1x70 l, blue	1638901

Equipe Advanced III

Description	code
Equipe Advanced III	1664313

Dimensions: 151 x 66 x 116 cm (W x D x H)

Set includes:

Description	code
4x Wheel, 125 mm	16922
2x bar incl. screws	16215
8x crossbeam, anthracite	1652706
1x stabilizer flat, anthracite	1654206
7x cover flat, anthracite	1645406
2x box 5 l, anthracite	1646106
1x bucket 6 l, blue	1642601
1x bucket 6 l, red	1642602
1x bucket 6 l, green	1642604
1x bucket 6 l, yellow	1642605
3x box 15 l, anthracite	1648006
2x 10 l box, blue	1640301
1x 10 l box, red	1640302
1x preparation box	1640405
1x holder 10 l box, L-plate	16354
3x lid, without seal	1649209
3x Attachment aid	16325
1x shock protection plus set Equipe (4 pcs), yellow	1656505
1x Extension unit Plus KL F, 125 mm, yellow	162811205
1x mop rest plus, yellow	1631205
1x Stabiliser short plus HR 2x40 l	16397
1x folding frame 1x40 l, yellow	1639005
1x folding frame 1x40 l, red	1639002
1x base frame L, without wheels, without bars	1621098
1x stabiliser with 6 hooks and 3 equipment holders, anthracite	1659406
1x folding frame 1x70 l, blue	1638901



Equipe Advanced IV

Description	code
Equipe Advanced IV	1664314

Dimensions: 182 x 66 x 116 cm (W x D x H)

Set includes:

Description	code
6x Wheel, 125 mm	16922
3x bar incl. screws	16215
1x coupler (set of 2 pieces)	16551
12x crossbeam, anthracite	1652706
1x stabilizer flat (right), anthracite	1654206R
7x cover flat, anthracite	1645406
1x box 5 l, anthracite	1646106
1x bucket 6 l, blue	1642601
1x bucket 6 l, red	1642602
1x bucket 6 l, green	1642604
1x bucket 6 l, yellow	1642605
1x holder for vacuum cleaner (set), extension M	16361
3x box 15 l, anthracite	1648006
3x 10 l box, blue	1640301
3x 10 l box, red	1640302
1x 4 l box, anthracite	1640506
1x preparation box	1640405
1x Stabiliser short, left , anthracite	1654506L
1x Stabiliser short, right , anthracite	1654506R
6x lid, without seal	1649209
6x Attachment aid	16325
1x shock protection plus set Equipe (4 pcs), yellow	1656505
1x Extension unit Plus KL F, 125 mm, yellow	162811205
1x mop rest plus, yellow	1631205
1x Stabiliser short plus HR 2x40 l	16397
1x folding frame 1x40 l, yellow	1639005
1x folding frame 1x40 l, red	1639002
1x stabiliser (left) with 6 hooks and 3 equipment holders, anthracite	1649506L
1x base frame M, without wheels, without bars	1623098
1x base frame L, without wheels, without bars	1621098
1x folding frame 1x70 l, blue	1638901

Equipe Base Plus I

Basic trolley for high-security areas and premium premises. The trolley comes equipped with buckets for surface cleaning and panelling. Augmented with a floor cleaning module, it offers everything needed for comprehensive cleaning and disposal tasks. The disposal unit can be detached with one simple move. This makes transporting it to the disposal area much easier, removing the need to take along the complete trolley. A foot pedal facilitates no-contact disposal.

Description	code
Equipe Base Plus I	1663315

Dimensions: 151 x 56 x 112 cm (W x D x H)

Set includes:

Description	code
4x Wheel, 125 mm	16922
2x bar incl. screws	16215
2x crossbeam, anthracite	1652706
2x stabilizer flat, anthracite	1654206
2x corner profile rail, anthracite	1670006
1x cover flat, anthracite	1645406
1x box 5 l, anthracite	1646106
1x box 35 l, anthracite	1646706
4x crossbeam one-sided, anthracite	1650706
2x shock protection plus set Equipe (4 pcs), yellow	1656505
1x Extension unit Plus C F, 125 mm yellow	162861205
1x door with handle bar "Platinum White" left, yellow	1675705L
2x side panel "Platinum White"	16529
1x Stabiliser short plus HR 2x40 l	16397
1x folding frame 1x40 l, blue	1639001
1x folding frame 1x40 l, red	1639002
1x corner profile rail with lock right and hinge left, anthracite	16726061
1x base frame L, without wheels, without bars	1621098
1x folding frame 1x70 l, yellow	1638905
1x Rear panel H "Platinum White", yellow	1679405
1x Swing door left	16396L
1x Swing door right	16396R



Equipe Base Plus II

Description	code
Equipe Base Plus II	1663316

Dimensions: 151 x 56 x 116 cm (W x D x H)

Set includes:

Description	code
4x Wheel, 125 mm	16922
2x bar incl. screws	16215
2x crossbeam, anthracite	1652706
2x stabilizer flat, anthracite	1654206
2x corner profile rail, anthracite	1670006
1x cover flat, anthracite	1645406
1x box 5 l, anthracite	1646106
1x bucket 6 l, blue	1642601
1x bucket 6 l, red	1642602
1x bucket 6 l, green	1642604
1x bucket 6 l, yellow	1642605
3x box 15 l, anthracite	1648006
8x crossbeam one-sided, anthracite	1650706
2x 10 l box, blue	1640301
1x 10 l box, red	1640302
1x preparation box	1640405
1x holder 10 l box, L-plate	16354
3x lid, without seal	1649209
3x Attachment aid	16325
1x shock protection plus set Equipe (4 pcs), yellow	1656505
1x Extension unit Plus KL F, 125 mm, yellow	162811205
1x door with handle bar "Platinum White" left, yellow	1675705L
2x side panel "Platinum White"	16529
1x Stabiliser short plus HR 2x40 l	16397
1x folding frame 1x40 l, yellow	1639005
1x folding frame 1x40 l, red	1639002
1x corner profile rail with lock right and hinge left, anthracite	16726061
1x base frame L, without wheels, without bars	1621098
1x folding frame 1x70 l, blue	1638901
1x Rear panel H "Platinum White", yellow	1679405

Equipe Base Plus III

Description	code
Equipe Base Plus III	1663317

Dimensions: 114 x 56 x 112 cm (W x D x H)

Set includes:

Description	code
4x Wheel, 125 mm	16922
2x bar incl. screws	16215
3x crossbeam, anthracite	1652706
2x corner profile rail, anthracite	1670006
1x cover flat, anthracite	1645406
8x crossbeam one-sided, anthracite	1650706
1x 10 l box, yellow	1640305
1x 10 l box, blue	1640301
1x 10 l box, red	1640302
1x 4 l box, anthracite	1640506
1x preparation box	1640405
1x Stabiliser short, left , anthracite	1654506L
1x Stabiliser short, right , anthracite	1654506R
3x lid, without seal	1649209
3x Attachment aid	16325
2x shock protection plus set Equipe (4 pcs), yellow	1656505
1x Extension unit Plus C F, 125 mm yellow	162861205
1x door with handle bar, small "Platinum White", left, yellow	1673705L
2x side panel "Platinum White"	16529
1x Stabiliser short plus HR 2x40 l	16397
1x Scandic X Toolbox "Platinum White", yellow	16460205
1x folding frame 1x40 l, yellow	1639005
1x folding frame 1x40 l, red	1639002
1x corner profile rail with lock right and hinge left, anthracite	16726061
1x base frame M, without wheels, without bars	1623098
1x folding frame 1x70 l, blue	1638901
1x corner profile rail with lock left, anthracite	16723061L
1x Rear panel H "Platinum White", yellow	1679405
1x Swing door left	16396L
1x Swing door right	16396R



Equipe Base Plus IV

Description	code
Equipe Base Plus IV	1663318
Dimensions: 104 x 56 x 112 cm (W x D x H)	

Set includes:

Description	code
4x Wheel, 125 mm	16922
2x bar incl. screws	16215
3x crossbeam, anthracite	1652706
2x corner profile rail, anthracite	1670006
1x cover flat, anthracite	1645406
8x crossbeam one-sided, anthracite	1650706
1x 10 l box, yellow	1640305
1x 10 l box, blue	1640301
1x 10 l box, red	1640302
1x 4 l box, anthracite	1640506
1x preparation box	1640405
1x Stabiliser short, left , anthracite	1654506L
1x Stabiliser short, right , anthracite	1654506R
3x lid, without seal	1649209
3x Attachment aid	16325
1x shock protection plus set Equipe (4 pcs), yellow	1656505
1x door with handle bar, small "Platinum White", left, yellow	1673705L
2x side panel "Platinum White"	16529
1x Stabiliser short plus HR 2x40 l	16397
1x Scandic X Toolbox "Platinum White", yellow	16460205
1x folding frame 1x40 l, yellow	1639005
1x folding frame 1x40 l, red	1639002
1x corner profile rail with lock right and hinge left, anthracite	16726061
1x base frame L for foot pedal, without wheels, without bars	1621198
1x holding frame Plus F with push bar handle, yellow	162891205
1x folding frame 1x70 l, blue	1638901
1x corner profile rail with lock left, anthracite	16723061L
1x Rear panel H "Platinum White", yellow	1679405

Equipe Advanced Plus I

Description	code
Equipe Advanced Plus I	1664315
Dimensions: 98 x 56 x 112 cm (W x D x H)	

Set includes:

Description	code
4x Wheel, 125 mm	16922
3x bar incl. screws	16215
7x crossbeam, anthracite	1652706
1x stabilizer flat (left), anthracite	1654206L
1x stabilizer flat (right), anthracite	1654206R
2x corner profile rail, anthracite	1670006
1x cover flat, anthracite	1645406
1x box 5 l, anthracite	1646106
3x box 15 l, anthracite	1648006
8x crossbeam one-sided, anthracite	1650706
1x 10 l box, yellow	1640305
1x 10 l box, blue	1640301
1x 10 l box, red	1640302
1x 4 l box, anthracite	1640506
1x preparation box	1640405
2x Stabiliser short, inner side , anthracite	1654506M
3x lid, without seal	1649209
3x Attachment aid	16325
1x shock protection plus set Equipe (4 pcs), yellow	1656505
1x door with handle bar "Platinum White" right, yellow	1675705R
1x door with handle bar, small "Platinum White", left, yellow	1673705L
2x side panel "Platinum White"	16529
1x rear panel "Platinum White",yellow	1679305
1x mop rest plus, yellow	1631205
1x double driving handle with handle holder, yellow	1659605
1x Scandic X Toolbox "Platinum White", yellow	16460205
1x inlying rail with lock and corner profile rail for door hinge l+r, anthracite	16722061
1x base frame L, without wheels, without bars	1621098
1x corner profile rail with lock left, anthracite	16723061L



Equipe Advanced Plus II

Description	code
Equipe Advanced Plus II	1664316

Dimensions: 155 x 56 x 114 cm (W x D x H)

Set includes:

Description	code
4x Wheel, 125 mm	16922
3x bar incl. screws	16215
6x crossbeam, anthracite	1652706
2x stabilizer flat (left), anthracite	1654206L
2x stabilizer flat (right), anthracite	1654206R
2x corner profile rail, anthracite	1670006
1x box 5 l, anthracite	1646106
1x lid for bucket 6 l, blue	1643701
1x lid for bucket 6 l, red	1643702
1x lid for bucket 6 l, green	1643704
1x lid for bucket 6 l, yellow	1643705
1x bucket 6 l, blue	1642601
1x bucket 6 l, red	1642602
1x bucket 6 l, green	1642604
1x bucket 6 l, yellow	1642605
4x box 15 l, anthracite	1648006
6x crossbeam one-sided, anthracite	1650706
1x shock protection plus set Equipe (4 pcs), yellow	1656505
1x Extension unit Plus KL F, 125 mm, yellow	162811205
1x door with handle bar "Platinum White" right, yellow	1675705R
1x door with handle bar "Platinum White" left, yellow	1675705L
2x side panel "Platinum White"	16529
1x rear panel "Platinum White",yellow	1679305
2x holding frame ZS 6 l	16324
1x Stabiliser short plus HR 2x40 l	16397
1x folding frame 1x40 l, green	1639004
1x folding frame 1x40 l, red	1639002
1x inlying rail with lock and corner profile rail for door hinge l+r, anthracite	16722061
1x base frame L, without wheels, without bars	1621098
1x folding frame 1x70 l, blue	1638901

Equipe Advanced Plus III

Description	code
Equipe Advanced Plus III	1664317

Dimensions: 151 x 66 x 116 cm (W x D x H)

Set includes:

Description	code
4x Wheel, 125 mm	16922
3x bar incl. screws	16215
8x crossbeam, anthracite	1652706
1x stabilizer flat (left), anthracite	1654206L
1x stabilizer flat (right), anthracite	1654206R
2x corner profile rail, anthracite	1670006
1x cover flat, anthracite	1645406
1x box 5 l, anthracite	1646106
3x box 15 l, anthracite	1648006
8x crossbeam one-sided, anthracite	1650706
1x 10 l box, yellow	1640305
1x 10 l box, blue	1640301
1x 10 l box, red	1640302
1x 4 l box, anthracite	1640506
1x preparation box	1640405
2x Stabiliser short, inner side , anthracite	1654506M
3x lid, without seal	1649209
3x Attachment aid	16325
2x shock protection plus set Equipe (4 pcs), yellow	1656505
1x Extension unit Plus C F, 125 mm yellow	162861205
1x door with handle bar "Platinum White" right, yellow	1675705R
1x door with handle bar, small "Platinum White", left, yellow	1673705L
2x side panel "Platinum White"	16529
1x rear panel "Platinum White",yellow	1679305
1x mop rest plus, yellow	1631205
1x Stabiliser short plus HR 2x40 l	16397
1x Scandic X Toolbox "Platinum White", yellow	16460205
1x folding frame 1x40 l, yellow	1639005
1x folding frame 1x40 l, red	1639002
1x inlying rail with lock and corner profile rail for door hinge l+r, anthracite	16722061
1x Equipment holder bar with 6 hooks incl. 3 equipment holder rubbers	16451
1x base frame L, without wheels, without bars	1621098
1x folding frame 1x70 l, blue	1638901
1x Swing door left "Platinum White"	16396L
1x Swing door right "Platinum White"	16396R
1x corner profile rail with lock left, anthracite	16723061L



Equipe Advanced Plus IV







Description	code
Equipe Advanced Plus IV	1664318









Dimensions: 192 x 66 x 116 cm (W x D x H)

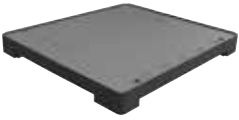
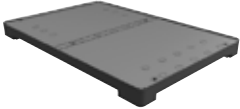

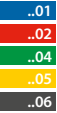

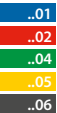



Set includes:











Description	code
6x Wheel, 125 mm	16922
3x bar incl. screws	16215
1x coupler (set of 2 pieces)	16551
7x crossbeam, anthracite	1652706
2x stabilizer flat (left), anthracite	1654206L
2x stabilizer flat (right), anthracite	1654206R
2x corner profile rail, anthracite	1670006
4x box 5 l, anthracite	1646106
1x lid for bucket 6 l, blue	1643701
1x lid for bucket 6 l, red	1643702
1x lid for bucket 6 l, green	1643704
1x lid for bucket 6 l, yellow	1643705
1x bucket 6 l, blue	1642601
1x bucket 6 l, red	1642602
1x bucket 6 l, green	1642604
1x bucket 6 l, yellow	1642605
1x protection against spillage	16469
1x dosing insert for box 35 l, yellow, incl. 2 grids	1646505
4x box 15 l, anthracite	1648006
1x box 35 l, anthracite	1646706
10x crossbeam one-sided, anthracite	1650706
2x shock protection plus set Equipe (4 pcs), yellow	1656505
1x Extension unit Plus C F, 125 mm yellow	162861205
1x door with handle bar "Platinum White" right, yellow	1675705R
1x door with handle bar "Platinum White" left, yellow	1675705L
2x side panel "Platinum White"	16529
1x rear panel "Platinum White", yellow	1679305



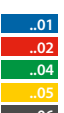

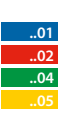



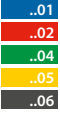

Description	code
2x holding frame ZS 6 l	16324
1x mop rest plus, yellow	1631205
1x Stabiliser short plus HR 2x40 l	16397
1x folding frame 1x40 l, yellow	1639005
1x folding frame 1x40 l, red	1639002
1x inlying rail with lock and corner profile rail for door hinge l+r, anthracite	16722061
1x Equipment holder bar with 6 hooks incl. 3 equipment holder rubbers	16451
1x base frame M, without wheels, without bars	1623098
1x base frame L, without wheels, without bars	1621098
1x folding frame 1x70 l, blue	1638901
1x Swing door left "Platinum White"	16396L
1x Swing door right "Platinum White"	16396R

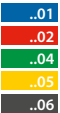

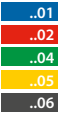



		code	pack. unit
WHEEL			
	<p>Wheel 100 mm</p>	16910	1
	<p>Wheel 125 mm</p>	16922	1
	<p>Wheel 150 mm</p>	15646	1
	<p>Wheel FB 100 mm</p> <hr/> <p>Equipped with: 1 lockable brake</p>	16911	1
	<p>Wheel FB 125 mm</p> <hr/> <p>Equipped with: 1 lockable brake</p>	16922FB	1
	<p>Wheel FB 150 mm</p> <hr/> <p>Equipped with: 1 lockable brake incl. adapter plate</p>	15646FB	1

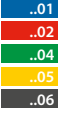

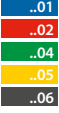
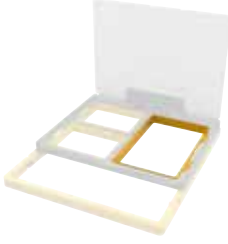
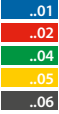
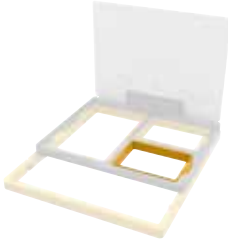

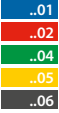

		code	pack. unit
BASE FRAME			
	base frame M, without wheels, without bars	1623098	1
	base frame L, without wheels, without bars	1621098	1
	base frame L for foot pedal, without wheels, without bars	1621198	1
ACCESSORIES BASE FRAMES			
	Scandic X Toolbox "Platinum White"	164602..	1
	pull-out fits all Scandic X System, Equipe Cleaning trolleys		
	shock protection plus set Equipe (4 pcs)	16565..	1
			
	shock-protection plus	16567..	1
			
	bar incl. screws	16215	1
			

		code	pack. unit
	Equipe "wall", multi-optional drawer level, inner side	1652106	1
	Equipe "wall", multi-optional drawer level, outer side	1652006	1
EXTENSION PLATES			
	extension S 100 mm 125 mm 150 mm	1624506 162451206 162454506	1 1 1
	Dimensions: 37 x 55 x 18 cm (W x D x H); Wheel 100 mm Equipped with: 1 castor Shock protection (code 16567..) to be ordered separately.		
	extension M 100 mm 125 mm 150 mm	1625506 162551206 162554506	1 1 1
	Dimensions: 41 x 55 x 18 cm (W x D x H); Wheel 100 mm Equipped with: 2 wheels Shock protection (code 16567..) to be ordered separately.		
	extension MFB 100 mm 125 mm 150 mm	1625506FB2 162551206FB2 162554506FB2	1 1 1
	Dimensions: 41 x 55 x 18 cm (W x D x H); Wheel 100 mm Equipped with: 2 wheels; 2 wheels lockable Shock protection (code 16567..) to be ordered separately.		
	coupler (set of 2 pieces)	16551	1
			



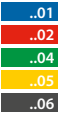



		code	pack. unit
EXTENSION UNITS, DETACHABLE			
	Extension unit Base C 100 mm 125 mm	16288.. 1628812..	1 1
	Dimensions: 63 x 55 x 111 cm (W x D x H); Wheel 100 mm Equipped with: 4 wheels; detachable from trolley; with holding frame height-adjustable push bar handle, coupler, covering panel, Please order separately: shock protection, foldable holding frame, bar with holding frame 2 x 40l, swing door, bar with hooks, holding clips for laundry net		
			
	Extension unit Base C FB 100 mm 125 mm	16288..FB 1628812..FB	1 1
	Dimensions: 63 x 55 x 111 cm (W x D x H); Wheel 100 mm Equipped with: 4 wheels; 2 wheels lockable; detachable from trolley; with holding frame height-adjustable push bar handle, coupler, covering panel, Please order separately: shock protection, foldable holding frame, bar with holding frame 2 x 40l, swing door, bar with hooks, holding clips for laundry net		
			
	Extension unit Plus C 100 mm 125 mm	16284.. 1628412..	1 1
	Dimensions: 63 x 55 x 111 cm (W x D x H); Wheel 100 mm Equipped with: 4 wheels; detachable from trolley; with holding frame height-adjustable push bar handle, lid with automatic immersion, covering panel, coupler, Please order separately: shock protection, foldable holding frame, bar with holding frame 2 x 40l, swing door, bar with hooks, holding clips for laundry net		
			
	Extension unit Plus C FB 100 mm 125 mm	16284..FB 1628412..FB	1 1
	Dimensions: 63 x 55 x 111 cm (W x D x H); Wheel 100 mm Equipped with: 4 wheels; 2 wheels lockable; detachable from trolley; with holding frame lid with automatic immersion, height-adjustable push bar handle, covering panel, coupler, Please order separately: shock protection, foldable holding frame, bar with holding frame 2 x 40l, swing door, bar with hooks, holding clips for laundry net		
			
	Extension unit Plus C F 100 mm 125 mm	16286.. 1628612..	1 1
	Dimensions: 63 x 55 x 111 cm (W x D x H); Wheel 100 mm Equipped with: 4 wheels; detachable from trolley; with holding frame coupler, lid with automatic immersion, height-adjustable push bar handle, covering panel, with foot pedal, Please order separately: shock protection, foldable holding frame, bar with holding frame 2 x 40l, swing door, bar with hooks, holding clips for laundry net		
			
	Extension unit Plus C F FB 100 mm 125 mm	16286..FB2 1628612..FB2	1 1
	Dimensions: 63 x 55 x 111 cm (W x D x H); Wheel 100 mm Equipped with: 4 wheels; 2 wheels lockable; detachable from trolley; with holding frame coupler, lid with automatic immersion, height-adjustable push bar handle, covering panel, with foot pedal, Please order separately: shock protection, foldable holding frame, bar with holding frame 2 x 40l, swing door, bar with hooks, holding clips for laundry net		
			







		code	pack. unit
EXTENSION UNITS, FOLDABLE			
 	Extension unit Base KL		
	100 mm	1628852..	1
	125 mm	1628875..	1
	150 mm	1628895..	1
<p>Dimensions: 63 x 55 x 111 cm (W x D x H); Wheel 100 mm Equipped with: 2 wheels; foldable function; with holding frame height-adjustable push bar handle, Please order separately: shock protection, foldable holding frame, bar with holding frame 2 x 40l, holding clips for laundry net</p>			
 	Extension unit Base KL FB		
	100 mm	1628852..FB	1
	125 mm	1628875..FB	1
	150 mm	1628895..FB	1
<p>Dimensions: 63 x 55 x 111 (W x D x H); Wheel 100 mm Equipped with: ; 2 wheels lockable; foldable function; with holding frame height-adjustable push bar handle, Please order separately: shock protection, foldable holding frame, bar with holding frame 2 x 40l, holding clips for laundry net</p>			
 	Extension unit Plus KL		
	100 mm	16285..	1
	125 mm	1628512..	1
	150 mm	1628545..	1
<p>Dimensions: 63 x 55 x 111 (W x D x H); Wheel 100 mm Equipped with: 2 wheels; foldable function; with holding frame lid with automatic immersion, height-adjustable push bar handle, Please order separately: shock protection, foldable holding frame, bar with holding frame 2 x 40l, holding clips for laundry net</p>			
 	Extension unit Plus KL FB		
	100 mm	16285..FB	1
	125 mm	1628512..FB	1
	150 mm	1628545..FB	1
<p>Dimensions: 63 x 55 x 111 cm (W x D x H); Wheel 100 mm Equipped with: 2 wheels lockable; foldable function; with holding frame lid with automatic immersion, height-adjustable push bar handle, Please order separately: shock protection, foldable holding frame, bar with holding frame 2 x 40l, holding clips for laundry net</p>			
 	Extension unit Plus KL F		
	100 mm	16281..	1
	125 mm	1628112..	1
	150 mm	1628145..	1
<p>Dimensions: 63 x 55 x 111 cm (W x D x H); Wheel 100 mm Equipped with: 2 wheels; foldable function; with holding frame with foot pedal, lid with automatic immersion, height-adjustable push bar handle, Please order separately: shock protection, foldable holding frame, bar with holding frame 2 x 40l, holding clips for laundry net</p>			
 	Extension unit Plus KL F FB		
	100 mm	16281..FB2	1
	125 mm	1628112..FB2	1
	150 mm	1628145..FB2	1
<p>Dimensions: 63 x 55 x 111 cm (W x D x H); Wheel 100 mm Equipped with: 2 wheels lockable; foldable function; with holding frame with foot pedal, lid with automatic immersion, height-adjustable push bar handle, Please order separately: shock protection, foldable holding frame, bar with holding frame 2 x 40l, holding clips for laundry net</p>			

		code	pack. unit
ACCESSORIES FOR ADD-ON KIT			
 	folding frame 1x70 l	16389..	1
 	folding frame 1x40 l	16390..	1
	holding clips (set of 4) for laundry net, attaches to foldable holding frame	1639106	1
 	Stabiliser short plus HR 2x40 l	16397	1
	Swing door left "Platinum White" Swing door right "Platinum White" for detachable extension unit, incl. corner profile rail, anthracite	16396L 16396R	1 1
 	mop rest plus	16312..	1







			code		pack. unit
		Equipment holder bar with 6 hooks incl. 3 equipment holder rubbers	16451		1
		with 6 hooks and 3 equipment holders for trolley and extension unit with panelling			
MODULES					
	module Des		16622..		1
	Set includes:				
	cover flat with Twixter equipment holder, anthracite	1x	1641406		1
	protection against spillage	1x	16469		1
	dosing insert for box 35 l, yellow, incl. 2 grids	1x	1646505		1
	box 35 l, anthracite	1x	1646706		1
	module Twixter-Press		16662		1
	Set includes:				
	cover flat with Twixter equipment holder, anthracite	1x	1641406		1
	Twixter wringer, yellow	1x	1871805		1
	tub 20 l, yellow	1x	1872405		1
	tub 20 l, anthracite	1x	1872306		1
	unit for wringer Twixter, stainless steel	1x	16343		1
	shock protection plus set Equipe (1 pcs), yellow	2x	1656705		1
	module F1		16699		1
	Set includes:				
	cover flat with Twixter equipment holder, anthracite	1x	1641406		1
	tub 20 l, yellow	1x	1872405		1
	tub 20 l, anthracite	1x	1872306		1
	unit for wringer Twixter, stainless steel	1x	16343		1
	F1 flat wringer press, yellow	1x	1867205		1
	shock protection plus set Equipe (1 pcs), yellow	2x	1656705		1
	module Mobox		16642		1
	Set includes:				
	cover flat with equipment holder, anthracite	1x	1641506		1
	lid with sealing for boxes 5 / 15 / 35 l, transparent with coloured imprint, transparent	2x	1648109		1
	box 15 l, anthracite	2x	1648006		1
	module Sprint		16672		1
	Set includes:				
	cover flat with equipment holder, anthracite	1x	1641506		1
	bucket 17 l, blue	1x	1641701		1
	bucket 17 l, red	1x	1641702		1
	vertical wringer VK 4, red	1x	1871402		1
	unit for wringer VK 4, stainless steel	1x	16340		1







EQUIPE | TOOLS – CLEANING TROLLEYS

		code	pack. unit	
	<p>module Sprint lateral</p> <hr/> <p>Set includes:</p> <p>cover flat with equipment holder, anthracite 1x 1641506 1</p> <p>vertical wringer VK 4, red 1x 1871402 1</p> <p>bucket 17 l, blue 1x 1875701 1</p> <p>bucket 17 l, red 1x 1875702 1</p> <p>unit for wringer VK 4, stainless steel, lateral 1x 16345 1</p>	16679	1	
	<p>CROSSBEAMS / TRIM STRIPS</p>			
		<p>crossbeam, anthracite</p>	1652706	1
		<p>crossbeam one-sided, anthracite</p> <hr/> <p>for fitting behind covering panel</p>	1650706	1
		<p>stabilizer flat, anthracite</p> <hr/> <p>for trolley with 2 bars</p>	1654206	1
		<p>stabiliser with 6 hooks and 3 equipment holders, anthracite</p> <hr/> <p>for trolley with 2 bars without panelling</p>	1659406	1
	<p>stabilizer flat (left), anthracite</p> <p>stabilizer flat (right), anthracite</p> <hr/> <p>for trolley with 3 bars</p>	1654206L 1654206R	1 1	







		code	pack. unit
	stabiliser (left) with 6 hooks and 3 equipment holders, anthracite	1649506L	1
	stabiliser (right) with 6 hooks and 3 equipment holders, anthracite	1649506R	1
	for Equipe trolley with 3 bars without panelling		
	Stabiliser short		
	inner side , anthracite	1654506M	1
	left , anthracite	1654506L	1
	right , anthracite	1654506R	1
	corner profile rail, anthracite	1670006	1
	inlying rail, anthracite	1670106	1
	corner profile rail with lock left, anthracite	16723061L	1
	for Toolbox		
	corner profile rail with lock left and hinge right, anthracite	16724061	1
	corner profile rail with lock right and hinge left, anthracite	16726061	1



EQUIPE | TOOLS – CLEANING TROLLEYS

			code	pack. unit
	inlying rail with lock and corner profile rail for door hinge I+r, anthracite		16722061	1
	inlying rail with lock and corner profile rail for door hinge, anthracite			
	adapter for section rail, anthracite		1670406	1
COVERS				
	cover flat, anthracite		1645406	1
	cover round with logo, anthracite		1645206	1
	cover flat with Twixter equipment holder, anthracite		1641406	1
	with equipment holder ø 20 – 28 mm (Art.Nr. 16548)			
	cover flat with equipment holder, anthracite		1641506	1
	with equipment holder ø 22 – 30 mm (Art.Nr. 16442)			





		code	pack. unit
	cover round, short, anthracite	1645506	1
MATERIAL ATTACHMENT			
	equipment holder ø 22 - 30 mm fits all with the following articles: 1659406, 1649506L, 1649506R, 1641506, 1658114, 16451, 16596..	16442	1
HOLDING FRAMES			
	holding frame base 2x70 l with push bar handle Equipped with: with holding frame, height-adjustable push bar handle position: rigid on L-plate Accessories Stabiliser short plus HR 2x40 l folding frame 1x40 l holding clips (set of 4) folding frame 1x70 l	1628952.. 16397 16390 1639106 16389	1 1 1 1 1
	holding frame 2x70 l with push bar handle Equipped with: with holding frame; height-adjustable push bar handle; lid with automatic immersion position: rigid on L-plate Accessories Stabiliser short plus HR 2x40 l folding frame 1x40 l holding clips (set of 4) folding frame 1x70 l	1628222.. 16397 16390 1639106 16389	1 1 1 1 1
	holding frame Plus F 2x70 l with push bar handle Equipped with: with holding frame, foot pedal; height-adjustable push bar handle; lid with automatic immersion position: rigid on L-plate Accessories Stabiliser short plus HR 2x40 l folding frame 1x40 l holding clips (set of 4) folding frame 1x70 l	1628912.. 16397 16390 1639106 16389	1 1 1 1 1
	holding frame ZS 6 l Material: stainless steel for 6 l immersible buckets	16324	1





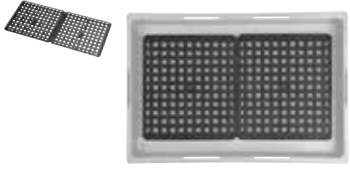
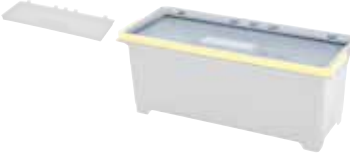



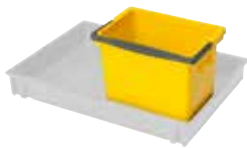

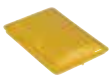
EQUIPE | TOOLS – CLEANING TROLLEYS

		code	pack. unit
	holding frame integrated 2 x 60 l, stainless steel	16371	1
	Material: stainless steel Equipped with: integrated fitting		
	Accessories laundry net holder 60, 1x20 l	1552766	1
	holding frame integrated 1 x 120 l, stainless steel	16351	1
	Material: stainless steel Equipped with: integrated fitting		
	laundry net holder 70 1x20 l 1x40 l	1552767 1552567	1 1
	for hook-up on holding frame 2 x 70 l		
	laundry net holder 60 1x20 l	1552766	1
	for hook-up on holding frame 2 x 60 l		
PUSH BAR HANDLE			
	double driving handle with handle holder	16596..	1
	Equipped with: 4 hooks, height-adjustable push bar handle, includes 2 equipment holder rubbers and cover, crossbeam		
..01 ..02 ..04 ..05 ..06			
BOXES / COVERS / ACCESSORIES			
	4 l box, anthracite	1640506	1
	Dimensions: 22 x 50 x 7 cm (W x D x H) fits all 10 l box		











			code	pack. unit
		<p>box 5 l, anthracite</p> <hr/> <p>Dimensions: 35 x 50 x 7 cm (W x D x H)</p>	1646106	1
		<p>box 10 l</p> <hr/> <p>Dimensions: 22 x 50 x 20,5 cm (W x D x H)</p>	16403..	1
<p>..01</p> <p>..02</p> <p>..04</p> <p>..05</p> <p>..06</p>				
		<p>box 15 l, anthracite</p> <hr/> <p>Dimensions: 35 x 50 x 17 cm (W x D x H)</p>	1648006	1
		<p>box 35 l, anthracite</p> <hr/> <p>Dimensions: 35 x 50 x 30 cm (W x D x H)</p>	1646706	1
		<p>preparation box</p> <hr/> <p>Dimensions: 22 x 50 x 8 cm (W x D x H) fits all 10 l box</p>	1640405	1
		<p>wetting box, anthracite</p> <hr/> <p>Dimensions: 35 x 50 x 7 cm (W x D x H)</p>	1642106	1





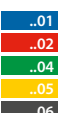

EQUIPE | TOOLS – CLEANING TROLLEYS







		code	pack. unit
	Attachment aid fits all 10 l box	16325	1
	grid for boxes 15 l / 35 l (set)	1881609	1
	lid with seal without seal fits all 10 l box	1629009 1649209	1 1
 <div data-bbox="151 1209 215 1332"> <ul style="list-style-type: none"> ..01 ..02 ..04 ..05 ..06 </div>	lid without sealing for boxes 5 / 15 / 35 l, fully-coloured without imprint	16482..	1
 <div data-bbox="151 1467 215 1601"> <ul style="list-style-type: none"> ..01 ..02 ..04 ..05 ..06 ..09 </div>	lid with sealing for boxes 5 / 15 / 35 l, transparent with coloured imprint	16481..	1
BUCKETS / COVERS / ACCESSORIES			
	bucket 6 l Dimensions: 25 x 17 x 22,5 cm (W x D x H)	16426..	1
 <div data-bbox="151 1758 215 1892"> <ul style="list-style-type: none"> ..01 ..02 ..04 ..05 ..06 ..09 </div>	Accessories grid set for buckets 6 l	1890206	1



		code	pack. unit
 	lid for bucket 6 l	16437..	1
 	bucket 8 l Dimensions: 34,5 x 17 x 23 cm (W x D x H) Accessories grid set for buckets 8 l	16428.. 1891609	1 1
 	lid for bucket 8 l	16435..	1
 	bucket 17 l Dimensions: 34,5 x 25 x 30 cm (W x D x H)	16417..	1
 	panning-lid	16434..	1
TROLLEY COVERING PANELS			
 	door with handle bar "Platinum White" left door with handle bar "Platinum White" right coloured handle bar	16757..L 16757..R	1 1

EQUIPE | TOOLS – CLEANING TROLLEYS

			code	pack. unit
 	<p>door with handle bar, small "Platinum White", left</p> <hr/> <p>coloured handle bar</p>		16737..L	1
	<p>side panel "Platinum White"</p>		16529	1
	<p>side panel "Platinum White" for Multiwall</p> <hr/> <p>consists of 3 parts</p>		16539	1
 	<p>rear panel "Platinum White"</p> <hr/> <p>coloured decorative strip</p>		16793..	1
 	<p>rear panel H "Platinum White"</p> <hr/> <p>coloured decorative strip</p>		16794..	1
 	<p>rear panel H + 10 l box "Platinum white"</p> <hr/> <p>coloured decorative strip</p>		1674280..	1

		code	pack. unit
	<p>rear panel H + Toolbox "Platinum White"</p> <hr/> <p>coloured decorative strip</p>	1674276..	1
<p>SHELVES / HOLDERS</p>			
	<p>holder for vacuum cleaner (set), extension M</p> <hr/> <p>holder for vacuum cleaner for base frame L (set)</p> <hr/> <p>also holds boxes 5 l - 35 l</p>	16361 16362	1 1
	<p>holder 10 l box</p> <p>L-plate</p> <hr/> <p>position: L-plate Equipped with: 3 bars</p>	16354	1
	<p>holder Chemical centre ST</p> <hr/> <p>position: stabilizer</p>	16448	1
	<p>holder Chemical centre TR</p> <p>standard</p> <p>raised</p> <hr/> <p>position: crossbeam</p>	16581 16581VK3	1 1
	<p>holding frame for chemical centre for crossbeam with equipment holder (Equipe)</p> <hr/> <p>position: crossbeam with equipment holder \varnothing 20 – 28 mm (Art.Nr. 16548)</p>	1658114	1

		code	pack. unit
ACCESSORIES			
	chemical centre, anthracite lockable	1658006	1
	work schedule holder	16335..	1
	work schedule holder Plus stick on wallet for DIN A4 for lid with automatic immersion	16431	1
	toilet paper holder stainless steel	16353	1
	holder Des for desinfectant bottles 500ml and 1000ml pursuant to Euro standard	16534	1
	dosing pump for desinfectant bottle fits all with the following articles: 16534	16537	1

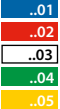
		code	pack. unit
SACS / NETS			
	waste sac		
	40 l	12245..	1
	70 l	12265..	1
	120 l	12225..	1
			
laundry net			
	laundry net		
	20 l	12130..	10
	40 l	12160..	10
	70 l	12170..	10
	120 l	12175..	10
			

CLEANING TROLLEYS



 TOOLS

EQUIPE HOTEL

CLEANING TROLLEYS

The models of the Equipe Hotel trolley series distinguish themselves through their adaptability. High-quality materials not only ensure an exclusive look, but also guarantee the long service life of this Hotel trolley. In addition, they offer an outstanding spectrum of design and application possibilities according to the modular principle.

Q AT A GLANCE

- **Stay focused**

All the necessary equipment and materials are clearly organised and sorted

- **Highest loading capacity**

Optimum use is made of the volume of the cleaning trolley

- **Easier work**

The low weight of the Equipe hotel trolley and its castors on ball bearings make it easy to manoeuvre

- **Modular cleaning trolley**

Maximum configuration flexibility

- **Durability**

High-quality material and clever design make this trolley particularly durable

AREAS OF APPLICATION

- Disposal
- Supply
- General cleaning

SITE



Hotel





Equipe H1 Light Grey

With four shelves, the Equipe H1 offers lots of storage space. With the Light Grey covering panels, its visual appearance is that of one unit - professional and attractive. For simple manoeuvring, the waste unit features a practical height-adjustable driving handle and can also be covered with a panel.

Description	code
Equipe H1 Light Grey	16663

Dimensions: 141 x 57 x 136 cm (W x D x H)

Set includes:

Description	code
1x base frame L, Hotel, 3 bars, 4 wheels 125 mm	162731206
1x extension M, 125 mm	162551206
1x shock protection (set of 4), anthracite	1656606
1x coupler (set of 2 pieces)	16551
8x crossbeam, anthracite	1652706
2x stabilizer flat (left), anthracite	1654206L
2x stabilizer flat (right), anthracite	1654206R
6x cover flat, anthracite	1645406
2x cover round with logo, anthracite	1645206
2x box 5 l, anthracite	1646106
2x holding frame for shelves, stainless steel	16532
2x profile rail for compartment	1678506
2x corner profile rail, hotel	1678006
2x corner profile rail for door, hotel	1678106
2x compartment "Light Grey"	16488
1x side panel "Light Grey", for holding frame	16744
1x side panel "Light Grey", without holding frame	16741
1x Rear panel H "Light Grey"	16743
2x door with handle "Light Grey", anthracite	1674906
1x holding frame KL height-adjustable push bar handle 2x70 l, anthracite Equipe	1638006
1x shock protection plus set Equipe (4 pcs), anthracite	1656506



Equipe H2

The Equipe H2, with Light Grey covering panels on three sides, allows storage of small items in either the small or large box. This model features an extension with disposal unit and two large shelves with abundant space for linen.

Description	code
Equipe H2	16667

Dimensions: 141 x 57 x 140 cm (W x D x H)

Set includes:

Description	code
1x base frame L, Hotel, 3 bars, 4 wheels 125 mm	162731206
1x extension M, 125 mm	162551206
1x shock protection (set of 4), yellow	1656605
1x coupler (set of 2 pieces)	16551
8x crossbeam, anthracite	1652706
2x stabilizer flat (left), anthracite	1654206L
2x stabilizer flat (right), anthracite	1654206R
6x cover flat, anthracite	1645406
2x cover round with logo, anthracite	1645206
2x box 5 l, anthracite	1646106
1x bucket 6 l, blue	1642601
1x bucket 6 l, red	1642602
1x bucket 6 l, green	1642604
1x bucket 6 l, yellow	1642605
2x holding frame for shelves, stainless steel	16532
2x profile rail for compartment	1678506
4x corner profile rail, hotel	1678006
2x compartment "Light Grey"	16488
1x side panel "Light Grey", for holding frame	16744
1x side panel "Light Grey", without holding frame	16741
1x Rear panel H "Light Grey"	16743
1x box 15 l, anthracite	1648006
2x crossbeam one-sided, anthracite	1650706
1x holding frame KL height-adjustable push bar handle 2x70 l, yellow Equipe	1638005
1x shock protection plus set Equipe (4 pcs), yellow	1656505



Equipe H3

The Equipe H3 is a basic model of the Equipe Hotel range. Enclosed with Light Grey covering panels on three sides, it has a 5l box and top shelf, ideal for storage. The trolley can be expanded at any time with extensions, in order to accommodate for example waste systems or, the Jetvac vacuum cleaner. The Equipe H3, like all Equipe Hotel trolleys, is extra high - with extremely generous storage space for linen or other room cleaning utensils.

Description	code
Equipe H3	16661
Dimensions: 83 x 57 x 136 cm (W x D x H)	

Set includes:

Description	code
1x base frame L, Hotel, 3 bars, 4 wheels 125 mm	162731206
1x shock protection (set of 4), yellow	1656605
9x crossbeam, anthracite	1652706
2x stabilizer flat (left), anthracite	1654206L
2x stabilizer flat (right), anthracite	1654206R
6x cover flat, anthracite	1645406
2x cover round with logo, anthracite	1645206
2x box 5 l, anthracite	1646106
2x holding frame for shelves, stainless steel	16532
2x profile rail for compartment	1678506
4x corner profile rail, hotel	1678006
2x compartment "Light Grey"	16488
2x side panel "Light Grey", without holding frame	16741
1x Rear panel H "Light Grey"	16743
1x shock protection plus set Equipe (4 pcs), yellow	1656505

Equipe Minibar, small

Description	code
Equipe Minibar, small	16629
Dimensions: 46 x 57 x 111 cm (W x D x H)	

Set includes:

Description	code
1x base frame M 2H, 125 mm	162301206
1x shock protection (set of 4), yellow	1656605
6x crossbeam, anthracite	1652706
2x stabilizer flat, anthracite	1654206
4x corner profile rail, anthracite	1670006
4x cover flat, anthracite	1645406
2x cover round with logo, anthracite	1645206
1x box 5 l, anthracite	1646106
1x Light Grey, "Light Grey" ,	16742
2x side panel "Light Grey", Equipe	16740
1x shelf "Light Grey", narrow	16498
1x profile for shelf, narrow	1678606
1x holding frame for shelf, narrow	16531
1x box 15 l, anthracite	1648006
2x crossbeam one-sided, anthracite	1650706
1x shock protection plus set Equipe (4 pcs), yellow	1656505



Equipe Hotel, large

Description	code
Equipe Hotel, large	16673

Dimensions: 125 x 57 x 136 cm (W x D x H)

Set includes:

Description	code
1x base frame L, Hotel, 3 bars, 4 wheels 125 mm	162731206
1x shock protection (set of 4), yellow	1656605
17x crossbeam, anthracite	1652706
2x stabilizer flat, anthracite	1654206
2x stabilizer flat (left), anthracite	1654206L
2x stabilizer flat (right), anthracite	1654206R
10x cover flat, anthracite	1645406
2x cover round with logo, anthracite	1645206
3x box 5 l, anthracite	1646106
2x holding frame for shelves, stainless steel	16532
2x profile rail for compartment	1678506
8x corner profile rail, hotel	1678006
2x compartment "Light Grey"	16488
4x side panel "Light Grey", without holding frame	16741
1x Rear panel H "Light Grey"	16743
2x shelf "Light Grey", narrow	16498
2x profile for shelf, narrow	1678606
2x holding frame for shelf, narrow	16531
2x bar, extended, incl. fittings	16216
1x backpanel "Light Grey" to fit extension unit M	1674399
1x extension M HW, 2 wheels 125 mm, anthracite	162351206
1x shock protection plus set Equipe (4 pcs), yellow	1656505







Equipe Laundry trolley, 2 x 120 l

Description	code
Equipe Laundry trolley, 2 x 120 l	16636







Dimensions: 83 x 57 x 111 cm (W x D x H)





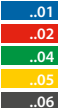

Set includes:











Description	code
1x base frame L 3H, 125 mm	162701206
1x shock protection (set of 4), yellow	1656605
8x crossbeam, anthracite	1652706
2x stabilizer flat (left), anthracite	1654206L
2x stabilizer flat (right), anthracite	1654206R
4x corner profile rail, anthracite	1670006
2x inlying rail, anthracite	1670106
4x cover flat, anthracite	1645406
2x cover round with logo, anthracite	1645206
2x Light Grey, "Light Grey"	16742
2x side panel "Light Grey", Equipe	16740
2x holding frame integrated 1 x 120 l, stainless steel	16351
1x shock protection plus set Equipe (4 pcs), yellow	1656505

		code	pack. unit
BASE FRAMES			
	base frame L, Hotel, 3 bars, 4 wheels 125 mm	162731206	1
	base frame L, Hotel, 3 bars, 4 wheels 150 mm	162734506	1
	base frame L Hotel, 3 bars, 4 wheels 125 mm with 2 lockable brakes	162731206FB2	1
	base frame L Hotel, 3 bars, 4 wheels 150 mm with 2 lockable brakes	162734506FB2	1
	Dimensions: 83 x 55 x 135 cm (W x D x H) Shock protection (code 6566..) or buffer wheels (code 561920L/R) to be ordered separately.		
WHEEL			
	Wheel		
	125 mm	16922	1
	Wheel		
	150 mm	15646	1
	Wheel FB		
	125 mm	16922FB	1
	Equipped with: 1 lockable brake		
	Wheel FB		
	150 mm	15646FB	1
	Equipped with: 1 lockable brake incl. adapter plate		
	buffer wheel for Equipe Hotel (right)	1561920R	1
	buffer wheel for Equipe Hotel (left)	1561920L	1



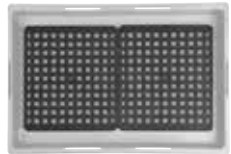

		code	pack. unit
ACCESSORIES BASE FRAMES			
 	shock protection for Equipe (set of 4)	16566..	1
EXTENSION PLATES			
 	extension S 125 mm 150 mm	162451206 162454506	1 1
Dimensions: 37 x 55 x 18 cm (W x D x H); Wheel 125 mm Equipped with: 1 castor Shock protection (code 16567..) to be ordered separately.			
 	extension M 125 mm 150 mm	162551206 162554506	1 1
Dimensions: 41 x 55 x 18 cm (W x D x H); Wheel 125 mm Equipped with: 2 wheels Shock protection (code 16567..) to be ordered separately.			
 	coupler (set of 2 pieces)	16551	1
CROSSBEAMS / TRIM STRIPS			
 	crossbeam, anthracite	1652706	1
 	stabilizer flat (left), anthracite stabilizer flat (right), anthracite	1654206L 1654206R	1 1
for Equipe trolley with 3 bars			





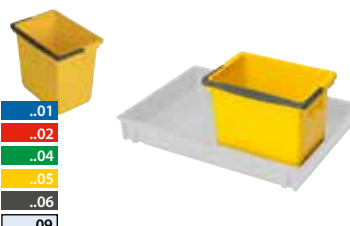

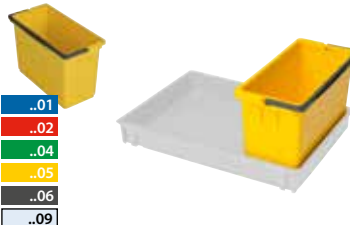



			code	pack. unit
	stabiliser (left) with 6 hooks and 3 equipment holders, anthracite		1649506L	1
	stabiliser (right) with 6 hooks and 3 equipment holders, anthracite		1649506R	1
		for Equipe trolley with 3 bars		
	corner profile rail, hotel		1678006	1
	corner profile rail for door, hotel		1678106	1
	adapter for section rail, anthracite		1670406	1
	profile rail for compartment		1678506	1
HOLDING FRAME				
	holding frame KL height-adjustable push bar handle 2x70 l		16380..	1
	Material: stainless steel Equipped with: collapsible; height-adjustable push bar handle			
	Accessories			
	laundry net holder 70, 1x20 l		1552767	1
	laundry net holder 70, 1x40 l		1552567	1
	holding frame KL without push bar handle 1x120 l		1635010	1
	Material: stainless steel Equipped with: collapsible; without push bar handle			

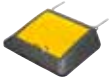

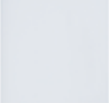

			code	pack. unit
 <p>..01 ..02 ..04 ..05 ..06</p>	<p>holding frame KL height-adjustable push bar handle 1x120 l</p>	<p>16392..</p>	<p>1</p>	
<p>Material: stainless steel Equipped with: collapsible; height-adjustable push bar handle</p>				
	<p>holding frame for shelves, stainless steel</p>	<p>16532</p>	<p>1</p>	
<p>SHELF / COMPARTMENT DIVIDER</p>				
	<p>shelf "Light Grey", narrow</p>	<p>16498</p>	<p>1</p>	
	<p>compartment "Light Grey"</p>	<p>16488</p>	<p>1</p>	
	<p>compartment divider for box 5 l, four-fold</p>	<p>1648904</p>	<p>1</p>	
	<p>compartment divider for box 5 l, eight-fold</p>	<p>1648908</p>	<p>1</p>	

		code	pack. unit
BOXES / COVERS / ACCESSORIES			
		box 5 l, anthracite Dimensions: 35 x 50 x 7 cm (W x D x H)	1646106 1
		box 15 l, anthracite Dimensions: 35 x 50 x 17 cm (W x D x H)	1648006 1
		box 35 l, anthracite Dimensions: 35 x 50 x 30 cm (W x D x H)	1646706 1
		wetting box, anthracite Dimensions: 35 x 50 x 7 cm (W x D x H)	1642106 1
		grid for boxes 15 l / 35 l (set)	1881609 1
		lid without sealing for boxes 5 / 15 / 35 l, fully-coloured without imprint	16482.. 1

- ..01
- ..02
- ..04
- ..05
- ..06

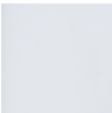
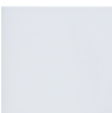
		code	pack. unit
	lid with sealing for boxes 5 / 15 / 35 l, transparent with coloured imprint	16481..	1
BUCKETS / COVERS / ACCESSORIES			
	bucket 6 l Dimensions: 25 x 17 x 22,5 cm (W x D x H)	16426..	1
	Accessories grid set for buckets 6 l	1890206	1
	lid for bucket 6 l	16437..	1
	bucket 8 l Dimensions: 34,5 x 17 x 23 cm (W x D x H)	16428..	1
	Accessories grid set for buckets 8 l	1891609	1
	lid for bucket 8 l	16435..	1
	bucket 17 l Dimensions: 34,5 x 25 x 30 cm (W x D x H)	16417..	1

		code	pack. unit
LID			
  <ul style="list-style-type: none"> .01 .02 .04 .05 .06 	panning-lid	16434..	1
  <ul style="list-style-type: none"> .01 .02 .04 .05 .06 	multi-function lid, lockable for holding frame with height-adjustable push bar handle	16477..	1
  <ul style="list-style-type: none"> .01 .02 .04 .05 .06 	lid for holding frame 120 l	16499..	1
WASTE SAC COATING			
 <ul style="list-style-type: none"> .01 .02 .04 .05 .06 .11 	waste sac coating for extension M	16710..	1
 <ul style="list-style-type: none"> .01 .02 .04 .05 .06 .11 	waste sac coating for detachable extension	16712..	1
TROLLEY COVERING PANELS			
  <ul style="list-style-type: none"> .01 .02 .04 .05 .06 	door with handle "Light Grey"	16749..	1

			code	pack. unit
 	side panel "Light Grey" for holding frame without holding frame		16744	1
			16741	1
 	Rear panel H "Light Grey"		16743	1
SACS / NETS				
 <ul style="list-style-type: none"> .01 .02 .05 .06 	Waste sac 40 l 70 l 120 l		12245..	1
			12265..	1
			12225..	1
 <ul style="list-style-type: none"> .01 .02 .03 .04 .05 	laundry net 20 l 40 l 70 l 120 l		12130..	10
			12160..	10
			12170..	10
			12175..	10



 TOOLS
SHOPSTER
CLEANING TROLLEYS



The Shopster cleaning trolley offers the familiar VERMOP functionality in the smallest of spaces. Innovative and cleverly-designed right down to the last detail, it offers all functions of a conventional cleaning trolley with the footprint of a double trolley.

With the largest selection of floor cleaning systems on the market for this trolley category, combined with smart solutions for material transport and disposal the Shopster is unique.

With its closed tidy look, Shopster ensures your cleaning staff make a professional impression.

Q AT A GLANCE

- **Compact size**

Footprint same as that of double trolley

- **Modular cleaning trolley**

Maximum configuration flexibility

- **Manoeuvrable**

Practical and manoeuvrable

- **Secure storage**

Lockable compartments prevent unauthorised access

- **Colour coding**

Flexible colour selection in accordance with the colour coding system

AREAS OF APPLICATION

- Premium premises
- Sanitary facilities
- Stairs

SITE



Small areas (Shop, Doctors' surgeries)

METHODS



Twix-Press • Vertical wringer VK 4 • Des tub • Pre-Wash • Dry cleaning • Spray method • Pour method





Shopster Twix-Press

The Shopster Twix-Press with flat wringer effortless wringing of the mop without touching or removing it from the holder. The drawer boxes offer lots of storage space for clean mops. The bucket and pivot boxes provide room for cloths and materials.

Description	code
Shopster Twix-Press	17991

Dimensions: 73 x 70 x 95 cm (W x D x H) | Color option anthracite/yellow is standard. Other color options surcharge. Buckets 8 l and inserts for boxes, pivot joints are excluded from this.

Set includes:

Description	code
1x base frame Shopster, 2 bars, 4 wheels, 75 mm, with 2 brakes, incl. shock protection, yellow	179107505
1x box 20 l, anthracite, for hook-up	1792006
1x work schedule holder	1795109
1x bucket, 8 l, blue	1792801
1x bucket, 8 l, red	1792802
2x box, pivot joint, 6 l	17940
1x Twix wringer 30 cm, yellow	1871305
1x holding frame, 2 x 35 l, incl. lid and push bars, yellow	1793505
1x covering panel, 3 sides, yellow	1797005
1x cupboard for consumables, 2 part compartment, hinged, lockable	17960
1x compartment	17948
1x push-in box, 20 l, anthracite, to fit at rear	1792906
1x drawer box, 20 l, for hook-up, at the front	1792406
2x lid for bucket, 8 l	17923
1x holding frame for mop	1795006
1x handle holder 2HN, 22 - 30 mm	1799226
1x equipment holder, in front, 20 - 30 mm	1799426

Accessories

Description	code
colour additive	17999

Shopster Sprint

The Shopster Sprint is equipped with a VK 4 vertical press. In buckets, pivot boxes and in the cupboard for consumables, cloths and other materials can be stored.

Description	code
Shopster Sprint	17971

Dimensions: 82 x 70 x 95 cm (W x D x H) | Color option anthracite/yellow is standard. Other color options surcharge. Buckets 8 l and inserts for boxes, pivot joints are excluded from this.

Set includes:

Description	code
1x base frame Shopster, 2 bars, 4 wheels, 75 mm, with 2 brakes, incl. shock protection, yellow	179107505
1x bucket 17 l, anthracite	1641706
1x work schedule holder	1795109
1x bucket, 8 l, blue	1792801
1x bucket, 8 l, red	1792802
2x box, pivot joint, 6 l	17940
1x holding frame, 2 x 35 l, incl. lid and push bars, yellow	1793505
1x covering panel, 3 sides, yellow	1797005
1x cupboard for consumables, 2 part compartment, hinged, lockable	17960
1x compartment	17948
1x push-in box, 20 l, anthracite, to fit at rear	1792906
2x lid for bucket, 8 l	17923
1x holding frame for mop	1795006
1x handle holder 2HN, 22 - 30 mm	1799226
1x vertical wringer VK 4, yellow	1871405
1x bucket, 10 l, yellow	1793005
1x unit for wringer VK 4 Shopster	17945

Accessories

Description	code
colour additive	17999



Shopster Pre-Wash I

In the Pre-Wash I there is lots of space for pre-prepared mops and cloths. Supplies can also be ideally stored.

Description	code
Shopster Pre-Wash I	17981

Dimensions: 73 x 70 x 95 cm (W x D x H) | Color option anthracite/yellow is standard. Other color options surcharge. Buckets 8 l and inserts for boxes, pivot joints are excluded from this.

Set includes:

Description	code
1x base frame Shopster, 2 bars, 4 wheels, 75 mm, with 2 brakes, incl. shock protection, yellow	179107505
1x work schedule holder	1795109
1x bucket, 8 l, blue	1792801
1x bucket, 8 l, red	1792802
2x box, pivot joint, 6 l	17940
1x holding frame, 2 x 35 l, incl. lid and push bars, yellow	1793505
1x covering panel, 3 sides, yellow	1797005
1x cupboard for consumables, 2 part compartment, hinged, lockable	17960
1x compartment	17948
1x push-in box, 20 l, anthracite, to fit at rear	1792906
3x drawer box, 20 l, for hook-up, at the front	1792406
1x insert for box, pivot joint, green	1794104
1x insert for box, pivot joint, yellow	1794105
2x lid for bucket, 8 l	17923
1x holding frame for mop	1795006
1x handle holder 2HN, 22 - 30 mm	1799226

Accessories

Description	code
colour additive	17999

Shopster Pre-Wash II

The Shopster Pre-Wash II is particularly narrow and fits through every conventional door. Sufficient space for pre-prepared cloths and mops is provided by the drawer boxes and the hook up box.

Description	code
Shopster Pre-Wash II	17982

Dimensions: 73 x 50 x 95 cm (W x D x H) | Color option anthracite/yellow is standard. Other color options surcharge. Buckets 8 l and inserts for boxes, pivot joints are excluded from this.

Set includes:

Description	code
1x base frame Shopster, 2 bars, 4 wheels, 75 mm, with 2 brakes, incl. shock protection, yellow	179107505
1x box 20 l, anthracite, for hook-up	1792006
1x work schedule holder	1795109
1x holding frame, 2 x 35 l, incl. lid and push bars, yellow	1793505
1x covering panel, 3 sides, yellow	1797005
1x cupboard for consumables, 2 part compartment, hinged, lockable	17960
1x compartment	17948
1x push-in box, 20 l, anthracite, to fit at rear	1792906
2x drawer box, 20 l, for hook-up, at the front	1792406
1x insert for box, pivot joint, red	1794102
1x insert for box, pivot joint, yellow	1794105
1x insert for box, pivot joint, blue	1794101
1x holding frame for mop	1795006
1x handle holder 2HN, 22 - 30 mm	1799226

Accessories

Description	code
colour additive	17999



Shopster Jetvac

Description	code
Shopster Jetvac	17961

Dimensions: 73 x 70 x 95 cm (W x D x H) | Color option anthracite/yellow is standard. Other color options surcharge. Buckets 8 l and inserts for boxes, pivot joints are excluded from this.

Set includes:

Description	code
1x base frame Shopster, 2 bars, 4 wheels, 75 mm, with 2 brakes, incl. shock protection, yellow	179107505
1x box 20 l, anthracite, for hook-up	1792006
1x work schedule holder	1795109
1x bucket, 8 l, blue	1792801
1x bucket, 8 l, red	1792802
2x box, pivot joint, 6 l	17940
1x holding frame, 2 x 35 l, incl. lid and push bars, yellow	1793505
1x covering panel, 3 sides, yellow	1797005
1x cupboard for consumables, 2 part compartment, hinged, lockable	17960
1x compartment	17948
1x push-in box, 20 l, anthracite, to fit at rear	1792906
2x lid for bucket, 8 l	17923
2x handle holder 2HN, 22 - 30 mm	17799226

Accessories

Description	code
colour additive	17999

Shopster Des

The Shopster Des with Des tub and Twix 30 cm system is the ideal equipment for disinfectant cleaning in clinics and doctors' surgeries. Additional mops can be transported in the push-in box; the pivot boxes and bucket offer space for colour-coded cloths for surface cleaning.

Description	code
Shopster Des	17933

Dimensions: 73 x 70 x 95 cm (W x D x H) | Color option anthracite/yellow is standard. Other color options surcharge. Buckets 8 l and inserts for boxes, pivot joints are excluded from this.

Set includes:

Description	code
1x base frame Shopster, 2 bars, 4 wheels, 75 mm, with 2 brakes, incl. shock protection, yellow	179107505
1x box 20 l, anthracite, for hook-up	1792006
1x work schedule holder	1795109
1x bucket, 8 l, blue	1792801
1x bucket, 8 l, red	1792802
2x box, pivot joint, 6 l	17940
1x holding frame, 2 x 35 l, incl. lid and push bars, yellow	1793505
1x covering panel, 3 sides, yellow	1797005
1x cupboard for consumables, 2 part compartment, hinged, lockable	17960
1x compartment	17948
1x push-in box, 20 l, anthracite, to fit at rear	1792906
1x drawer box, 20 l, for hook-up, at the front	1792406
1x dosing insert for box 20 l, yellow, incl. grid and protection against spillage	1792505
2x lid for bucket, 8 l	17923
1x holding frame for mop	1795006
1x handle holder 2HN, 22 - 30 mm	1799226
1x equipment holder, in front, Module Des	1799606

Accessories

Description	code
colour additive	17999



Shopster Stairs Sprint

The Shopster Stairs Sprint is perfectly equipped for cleaning steps and stairs. The two large castors make it easy to negotiate steps. The height-adjustable driving handle makes the ergonomic use of the trolley easier.

Description	code
Shopster Stairs Sprint	17973











Dimensions: 83 x 70 x 100 cm (W x D x H) | Color option anthracite/yellow is standard. Other color options surcharge. Buckets 8 l and inserts for boxes, pivot joints are excluded from this.





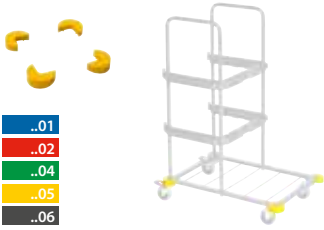





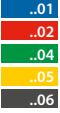

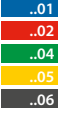
Set includes:

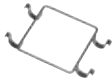



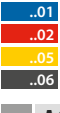

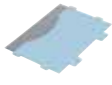



Description	code
1x base frame Stairs, incl. shock protection, yellow	1791305
1x bucket 17 l, anthracite	1641706
1x work schedule holder	1795109
1x bucket, 8 l, blue	1792801
1x bucket, 8 l, red	1792802
2x box, pivot joint, 6 l	17940
1x holding frame, 2 x 35 l, incl. lid and height-adjustable driving handle, yellow	1793705
1x covering panel, 3 sides, yellow	1797005
1x cupboard for consumables, 2 part compartment, hinged, lockable	17960
1x compartment	17948
1x push-in box, 20 l, anthracite, to fit at rear	1792906
2x lid for bucket, 8 l	17923
1x holding frame for mop	1795006
1x handle holder 2HN, 22 - 30 mm	1799226
1x vertical wringer VK 4, yellow	1871405
1x bucket, 10 l, yellow	1793005
1x unit for wringer VK 4 Shopster	17945







Accessories



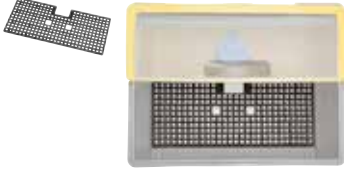

Description	code
colour additive	17999





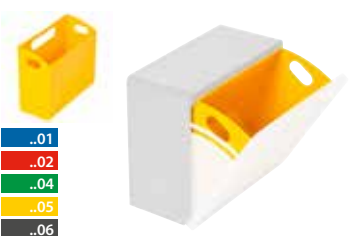

		code	pack. unit		
BASE FRAMES					
		base frame Shopster, 2 bars, 4 wheels, 75 mm, with 2 brakes, incl. shock protection	1791075..	1	
		Dimensions: 64 x 44,5 x 90 cm (W x D x H)			
			base frame Shopster, 2 bars, 4 wheels, 100 mm, with 2 brakes, incl. shock protection	17910..	1
			Dimensions: 64 x 44,5 x 92,5 cm (W x D x H)		
		base frame Shopster Stairs, incl. shock protection	17913..	1	
		Dimensions: 74 x 48 x 100 cm (W x D x H)			
ACCESSORIES					
		shock protection Shopster (set of 4)	17966..	1	
HOLDING FRAMES					
		holding frame, 1 x 70 l, incl. lid and height-adjustable driving handle	17938..	1	
		Accessories work schedule holder	1795109	1	
		holding frame, 2 x 35 l, incl. lid and height-adjustable driving handle	17937..	1	
		Accessories work schedule holder holding frame 1 x 20 l for hook-up on holding frame 2 x 35 l	1795109 15579	1 1	

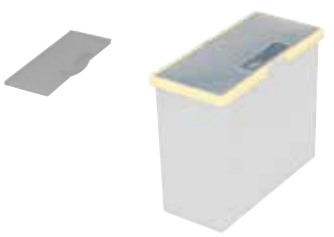
		code	pack. unit
 	holding frame, 1 x 70 l, incl. lid and push bars	17931..	1
	Accessories work schedule holder	1795109	1
 	holding frame, 2 x 35 l, incl. lid and push bars	17935..	1
	Accessories work schedule holder	1795109	1
	holding frame 1 x 20 l for hook-up on holding frame 2 x 35 l	15579	1
 	holding frame 1 x 20 l for hook-up on holding frame 2 x 35 l	15579	1
		for hook-up on holding frame 2 x 35 l	
SACS / NETS			
 	laundry net		
	20 l	12130..	10
	40 l	12160..	10
	70 l	12170..	10
 	Waste sac		
	40 l	12245..	1
	70 l	12265..	1
	70 l, short	12265..M	1
ACCESSORIES			
 	work schedule holder	1795109	1

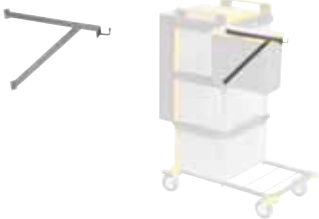



			code	pack. unit
	covering panel, 3 sides		17970..	1
<ul style="list-style-type: none"> .01 .02 .04 .05 .06 				
FLOOR CLEANING				
 	Twix wringer 30 cm		18713..	1
<ul style="list-style-type: none"> .01 .02 .04 .05 				
 	box 20 l, anthracite, for hook-up		1792006	1
<ul style="list-style-type: none"> .06 				
 	box 12 l, yellow, for hook-up		1792205	1
<ul style="list-style-type: none"> .05 				
 	dosing insert for box 20 l incl. grid and protection against spillage		17925..	1
<ul style="list-style-type: none"> .01 .05 				
 	protection against spillage		17936	1

		code	pack. unit
	insert grid, anthracite (Shopster), plastic	1880406	1
	vertical wringer VK 4	18714..	1
	wringer insert for VK 4	1886510	1
	unit for wringer VK 4 Shopster	17945	1
STORAGE			
	cupboard for consumables, 2 part compartment, hinged, lockable	17960	1
	compartment	17948	1

			code	pack. unit
	push-in box, 20 l, anthracite, to fit at rear		1792906	1
	drawer box, 20 l, for hook-up, at the front		1792406	1
	box, pivot joint, 6 l		17940	1
	insert for box, pivot joint		17941..	1
BUCKETS / COVERS / ACCESSORIES				
	bucket, 8 l Dimensions: 31 x 15 x 25,5 cm (W x D x H)		17928..	1
	lid for bucket, 8 l		17923	1

			code	pack. unit
	holding frame for bucket 8 l		17980	1
	bucket, 10 l Dimensions: 34,5 x 15 x 30 cm (W x D x H)	..01 ..05	17930..	1
	bucket 17 l Dimensions: 34,5 x 25 x 30 cm (W x D x H)	..01 ..06	16417..	1
MATERIAL ATTACHMENT				
	equipment holder, in front, ø 22 - 30 mm		1799406	1
	equipment holder, in front, Module Des		1799606	1
	handle holder 2HN ø 22 - 30 mm		1799226	1

SHOPSTER | TOOLS – CLEANING TROLLEYS

			code	pack. unit
		equipment holder, lateral, ø 22 - 30 mm	1799726	1
		holding frame for mop	1795006	1

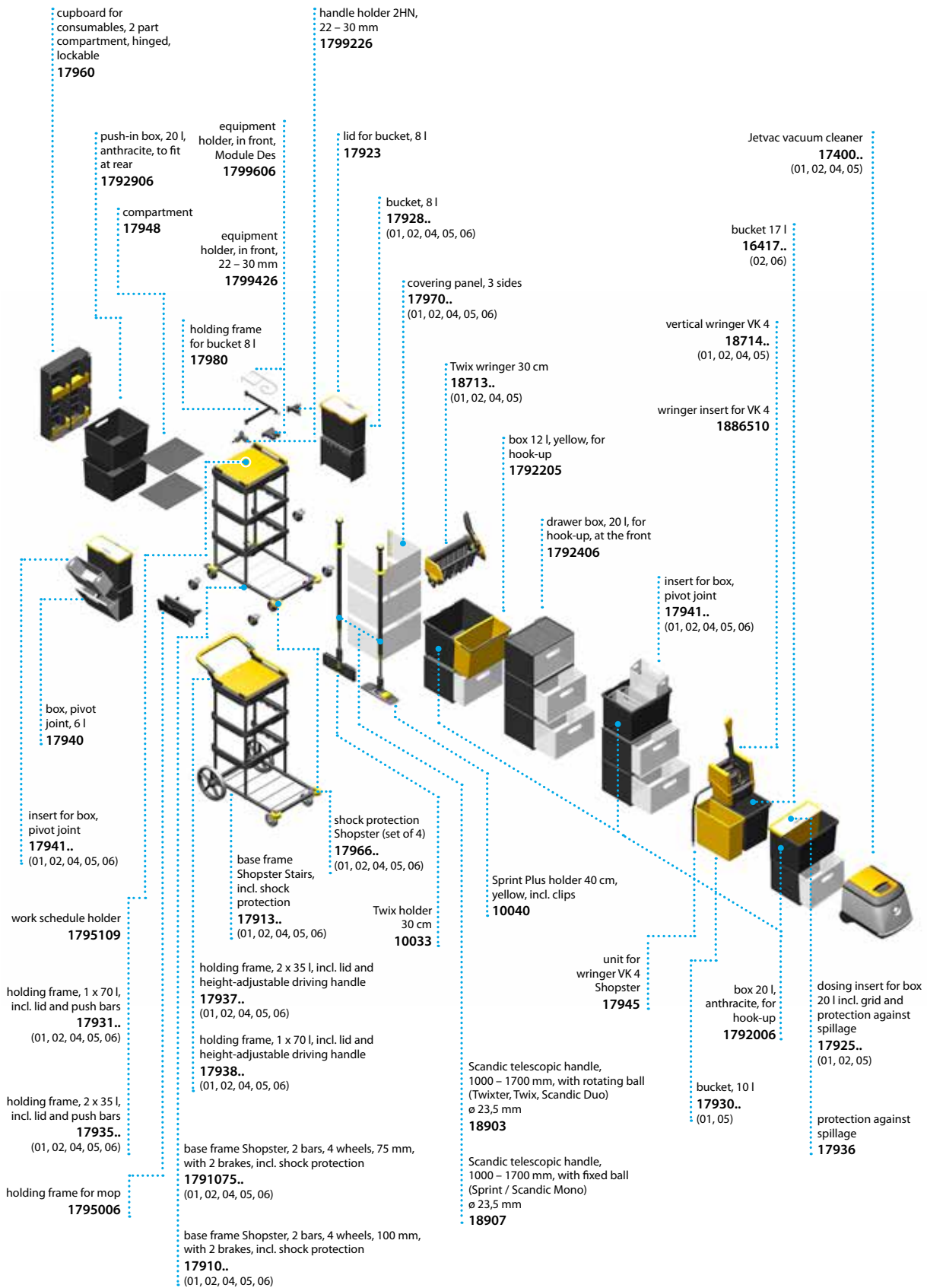

Q AT A GLANCE



- **Proven quality**
Proven durability and reliability
- **Comprehensive disposal options**
Flexible options for separating waste
- **Maximum overview**
Fast access to all material
- **Economical purchase**
Good value for money even for short-term contracts



TOOLS

VARIANT

CLEANING TROLLEYS

The Variant is the classic model among the functional VERMOP cleaning trolleys which has proven itself for years. The very economical Variant is available in two versions: in chromed steel and as the Variant Edition, in high-quality stainless steel. With the diverse equipment options leaving no requirements uncatered for, the Variant has the right solution for every area of use. High-quality materials guarantee stability and long service life.

AREAS OF APPLICATION

- Disposal
- Clean room

SITE



Office / Administration • Train • Industry • School / Nursery

METHODS



Twixter-Press • F1 flat wringer • Vertical wringer VK 4 • Des tub • Pre-Wash • Dosing sieve • Dry cleaning • Spray method • Pour method



Variant Twixter-Press (chrome coated)

For the efficient wet cleaning of large surfaces, the Variant Twixter wringer is equipped with the patented Twixter wringer, making this trolley ideal for general cleaning.

Delivery: Trolley not assembled

Description	code
Variant Twixter-Press (chrome coated)	11650UN
Dimensions: 145 x 60 x 110 cm (W x D x H)	

Set includes:

Description	code
1x base trolley III, wheels 100 mm, chrome-plated	10630
1x Twixter wringer, red	1871802
1x tub 20 l, blue	1872401
1x tub 20 l, red	1872302
2x holding frame for tray M, chrome-plated	10551
1x storage frame II incl. support wheel, fold away, wheel 75 mm	10505
1x holding frame 2 x 70 l, collapsible, chrome-plated	10507
1x unit for wet mop trolley Twixter / F1, chrome-plated	10504
3x tray M, blue	1875101
1x bucket 6 l, blue	1875601
1x bucket 6 l, red	1875602
1x bucket 6 l, yellow	1875605
1x equipment holder Twixter	15163

Variant Des 2000 / K (chrome coated)

Delivery: Trolley not assembled

Description	code
Variant Des 2000 / K (chrome coated)	10620UN
Dimensions: 125 x 77 x 110 cm (W x D x H)	

Set includes:

Description	code
1x base trolley II, wheels 100 mm, chrome-plated	10660
1x stick attachment, stainless steel	15541
2x holding frame for tray XL, chrome-plated	10559
1x storage frame II incl. support wheel, fold away, wheel 75 mm	10505
1x holding frame 2 x 70 l, collapsible, chrome-plated	10507
2x fixation for tub 45 l, chrome-plated	10528
1x dosing sieve	15551
1x disinfection tub, blue	1875801
2x tray XL, blue	1875201
1x bucket 6 l, blue	1875601
1x bucket 6 l, red	1875602
1x bucket 6 l, green	1875604
1x bucket 6 l, yellow	1875605



Variant 26 Ergo (chrome coated)

On the Variant 26 Ergo, the VK 4 wringer is attached in the best ergonomic position. The mop can be wrung out without bending, thus safeguarding the user's back. Ideal for wet mopping using the two-bucket method.

Delivery: Trolley not assembled

Description	code
Variant 26 Ergo (chrome coated)	10669UN
Dimensions: 125 x 75 x 122 cm (W x D x H)	

Set includes:

Description	code
1x base trolley II, wheels 100 mm, chrome-plated	10660
1x vertical wringer VK 4, red	1871402
1x holding frame 2x70 I, chrome-plated	10578
1x holding frame for 2 buckets 17 l, chrome-plated	10541
1x wringer holder II, chrome-plated	10547
1x grid II, chrome-plated	10588
2x wire basket III	10583
1x bucket 6 l, blue	1875601
1x bucket 6 l, red	1875602
1x bucket 17 l, blue	1875701
1x bucket 17 l, red	1875702
1x equipment holder double	1516377

Variant 27 (chrome coated)

The Variant 27 is ideal for daily general or industrial cleaning of large premises. The open construction makes all the equipment components easy to reach.

Delivery: Trolley not assembled

Description	code
Variant 27 (chrome coated)	10667UN
Dimensions: 125 x 68 x 110 cm (W x D x H)	

Set includes:

Description	code
1x base trolley II, wheels 100 mm, chrome-plated	10660
1x vertical wringer VK 4, red	1871402
1x stick attachment, stainless steel	15541
1x holding frame 2x70 I, chrome-plated	10578
2x holding frame for tray M, chrome-plated	10551
1x wringer holder, rigid, chrome-plated	10544
1x grid II, chrome-plated	10588
2x tray M, blue	1875101
1x bucket 6 l, blue	1875601
1x bucket 6 l, red	1875602
1x bucket 17 l, blue	1875701
1x bucket 17 l, red	1875702



Variant 23 (chrome coated)

The slim Variant 23 offers optimum disposal options for office cleaning, for example disposal of paper. In addition to this there is storage space for transporting accessories, e.g. vacuum cleaners and cleaning materials.

Delivery: Trolley not assembled

Description	code
Variant 23 (chrome coated)	10663UN

Dimensions: 96 x 52 x 105 cm (W x D x H)

Set includes:

Description	code
1x base trolley II, wheels 100 mm, chrome-plated	10660
1x holding frame 2x120 I, chrome-plated	10576
1x holding frame 1x120 I, chrome-plated	10550
2x tray M, blue	1875101
1x equipment holder double	1516377

Variant 20 (chrome coated)

Delivery: Trolley not assembled

Description	code
Variant 20 (chrome coated)	10612UN

Dimensions: 82 x 52 x 106 cm (W x D x H)

Set includes:

Description	code
1x base trolley II, wheels 100 mm, chrome-plated	10660
1x holding frame 2x120 I, chrome-plated	10576



Variant AS (chrome coated)

The Variant AS is the smallest trolley in the Variant series. It allows the Jetvac vacuum cleaner, to be transported with ease. The disposal system, the holder for cleaning materials and the various trays make the Variant AS, the ideal cleaning trolley for various premises even those with limited space.

Delivery: Trolley not assembled

Description	code
Variant AS (chrome coated)	10636UN

Dimensions: 79 x 52 x 105 cm (W x D x H)

Set includes:

Description	code
1x base trolley III, wheels 100 mm, chrome-plated	10630
1x holding frame 1 x 120 l, lateral, with grid, chrome-plated	10577
2x holding frame for tray M, chrome-plated	10551
2x tray M, blue	1875101
1x equipment holder double	1516377

Variant Twixter-Press (stainless steel)

For the efficient wet cleaning of large surfaces, the Variant Twixter wringer is equipped with the patented Twixter wringer, making this trolley ideal for general cleaning.

Delivery: Trolley not assembled

Description	code
Variant Twixter-Press (stainless steel)	15050UN

Dimensions: 145 x 59 x 110 cm (W x D x H)

Set includes:

Description	code
1x base trolley III, wheels 100 mm, stainless steel	15130
1x Twixter wringer, red	1871802
1x tub 20 l, blue	1872401
1x tub 20 l, red	1872302
1x holding frame 2x70 l, stainless steel	15178
2x holding frame for tray M, stainless steel	15151
1x grid II, stainless steel	15188
1x unit for wet mop trolley Twixter / F1, stainless steel	15108
3x tray M, blue	1875101
1x bucket 6 l, blue	1875601
1x bucket 6 l, red	1875602
1x bucket 6 l, yellow	1875605
1x equipment holder Twixter	15163



Variant 27 (stainless steel)

The Variant 27 is ideal for daily general or industrial cleaning of large premises. The open construction makes all the equipment components easy to reach.

Delivery: Trolley not assembled

Description	code
Variant 27 (stainless steel)	15127UN

Dimensions: 125 x 68 x 110 cm (W x D x H)

Set includes:

Description	code
1x base trolley II, wheels 100 mm, stainless steel	15160
1x vertical wringer VK 4, red	1871402
1x stick attachment, stainless steel	15541
1x holding frame 2x70 l, stainless steel	15178
2x holding frame for tray M, stainless steel	15151
1x wringer holder, rigid, stainless steel	15144
1x grid II, stainless steel	15188
2x tray M, blue	1875101
1x bucket 6 l, blue	1875601
1x bucket 6 l, red	1875602
1x bucket 17 l, blue	1875701
1x bucket 17 l, red	1875702

Variant cleanroom







The Variant cleanroom cleaning trolley in high-quality stainless steel has been developed and tested specifically for use in cleanrooms with stringent standards. The GMP-conforming material, the autoclavable wheels and the precise, premium workmanship has been proven by EU GMP A/B certification, tested by the Fraunhofer IPA Institute.







Description	code
Variant cleanroom	15119

Dimensions: 84 x 49,5 x 112 cm (W x D x H) | Material: stainless steel | Suitable for cleanroom use | conditioning: autoclavable | Certificate: EU GMP A/B













Set includes:













Description	code
4x bucket ED, 5,5 l	151662
1x box ED, 14 l	151663
1x box ED, 28 l	151661

		code	pack. unit
BASE FRAMES			
	base trolley III, wheels 100 mm, stainless steel	15130	1
	base trolley III, wheels 100 mm, chrome-plated	10630	1
	Dimensions: 56 x 52 x 105 cm (W x D x H); Wheel 100 mm		
	base trolley II, wheels 100 mm, stainless steel	15160	1
	base trolley II, wheels 125 mm, stainless steel	1516012	1
	base trolley II, wheels 100 mm, chrome-plated	10660	1
	base trolley II, wheels 125 mm, chrome-plated	1066012	1
	Dimensions: 82 x 52 x 106 cm (W x D x H); Wheel 100 mm		
	bar for base trolley	1060001	1
WHEELS			
	wheel, 100 mm, without lockable brake	18877	1
	Accessories brake for wheels 75 mm + 100 mm	1886906	1
	wheel, 125 mm, without lockable brake	17825	1
	wheel, 150 mm, without lockable brake	15645	1













		code	pack. unit
	wheel, 125 mm, with lockable brake	17826	1
	wheel with lockable brake, 150 mm Equipped with: 1 lockable brake	15645FB	1
	brake for wheels 75 mm + 100 mm	1886906	1
HOLDING FRAMES			
	holding frame 1x70 l chrome-plated position: at side for suspension	10570	1
	holding frame 2x70 l stainless steel chrome-plated position: at side for suspension	15178 10578	1 1
	holding frame 2 x 70 l, collapsible, chrome-plated	10507	1

VARIANT | TOOLS – CLEANING TROLLEYS













			code	pack. unit
		<p>holding frame 1x120 l stainless steel chrome-plated</p> <hr/> <p>position: at side for tray M</p>	15150 10550	1 1
		<p>holding frame 1 x 120 l, lateral, with grid, chrome-plated</p> <hr/> <p>position: at side for suspension</p>	10577	1
		<p>holding frame 1 x 120 l, lateral, with hook and grid, chrome-plated</p> <hr/> <p>position: at side with hook</p>	10574	1
		<p>holding frame 2x120 l stainless steel chrome-plated</p>	15176 10576	1 1
		<p>holding frame 2 x 20 l</p> <hr/> <p>for hook-up on holding frame 2 x 70 l</p>	15527	1
		<p>holding frame 1 x 40 l</p> <hr/> <p>for hook-up on holding frame 2 x 70 l</p>	15525	1





			code	pack. unit
 	holding frame for tray M, stainless steel	15151	1	
	holding frame for tray M, chrome-plated	10551	1	
 	holding frame for tray L, stainless steel	15158	1	
	holding frame for tray L, chrome-plated	10558	1	
 	holding frame for tray XL, stainless steel	15159	1	
	holding frame for tray XL, chrome-plated	10559	1	
 	holding frame for 2 buckets 17 l, stainless steel	15141	1	
	holding frame for 2 buckets 17 l, chrome-plated	10541	1	
GRID				
 	storage frame II incl. support wheel, fold away, wheel 75 mm	10505	1	
 	storage frame II incl. support wheel, wheel 100 mm	1518810	1	
	storage frame II incl. support wheel, fold away, wheel 100 mm	1050510	1	

VARIANT | TOOLS – CLEANING TROLLEYS



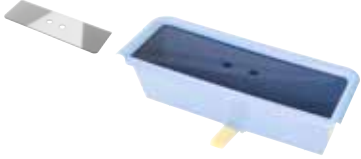

			code	pack. unit
		<p>grid II stainless steel chrome-plated</p> <hr/> <p>for suspension</p>	<p>15188 10588</p>	<p>1 1</p>
		<p>grid for tub 45 l with supporting wheel, stainless steel grid for tub 45 l with supporting wheel, chrome-plated</p>	<p>15185 1050599</p>	<p>1 1</p>
		<p>grid MB stainless steel chrome-plated</p> <hr/> <p>for suspension</p>	<p>15182 11422</p>	<p>1 1</p>
		<p>grid for Mobox with supporting wheel</p>	<p>1142210</p>	<p>1</p>
		<p>unit for wet mop trolley Twixter / F1, chrome-plated</p>	<p>10504</p>	<p>1</p>
MATERIAL ATTACHMENT				
		<p>equipment holder double</p>	<p>1516377</p>	<p>1</p>







			code	pack. unit
		stick attachment, stainless steel	15541	1
		equipment holder	18797	1
		equipment holder Twixter	15163	1
		equipment holder, plastic, anthracite equipment holder, plastic, blue	1877006 1877001	1 1
		equipment holder for tray XL, anthracite equipment holder for tray XL, blue	1058006 1058001	1 1
		attachment incl. 2 hooks, stainless steel	15543	1







			code	pack. unit
		vacuum cleaner tube holder	15146	1
		supporting grid for mop holder, lateral	10586	1
SHELVES / HOLDERS				
		wringer holder II, chrome-plated	10547	1
		wringer holder, rigid, chrome-plated	10544	1
TUBS / TRAYS				
		<p>disinfection tub</p> <hr/> <p>Dimensions: 65 x 48 x 24 cm (W x D x H) volume: 45 l</p>	18758..	1
				
		<p>Twixter dosing insert MS</p> <hr/> <p>Equipped with: incl. 2 grids</p>	18831..	1
				







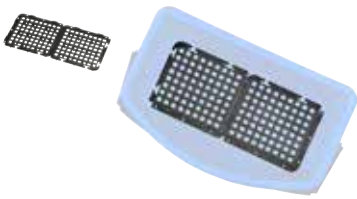

		code	pack. unit
 <p>..01 ..06</p>	<p>Twixter dosing insert</p>	18832..	1
	<p>protection against spillage for dosing insert</p>	18707	1
	<p>dosing sieve</p> <hr/> <p>Material: stainless steel</p>	15551	1
	<p>dosing sieve ED</p> <hr/> <p>Material: stainless steel Suitable for cleanroom use conditioning: autoclavable</p>	151666	1
 <p>..01 ..05</p>	<p>tub 20 l</p> <hr/> <p>volume: 20 l combination only possible with 1 x tub 18724.. and 1 x tub 18723..</p>	18724..	1
 <p>..02 ..06</p>	<p>tub 20 l</p> <hr/> <p>volume: 20 l combination only possible with 1 x tub 18724.. and 1 x tub 18723..</p>	18723..	1

VARIANT | TOOLS – CLEANING TROLLEYS

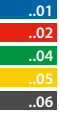

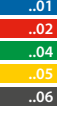
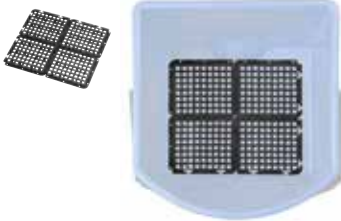

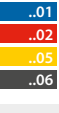

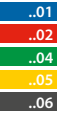
		code	pack. unit
 <p> ..01 ..02 ..04 ..05 </p>	Moboxx, anthracite with coloured clips	18630..	1
	grid for boxes 15 l / 35 l (set)	1881609	1
	lid for Moboxx with seal	1864506	1
	Moboxx sealing ring	18655	1
 <p> ..01 ..02 ..04 ..05 </p>	clip for Moboxx	18640..	1
 <p> ..01 ..06 </p>	<p>tray M</p> <hr/> <p>Dimensions: 51 x 32 x 9 cm (W x D x H)</p>	18751..	1





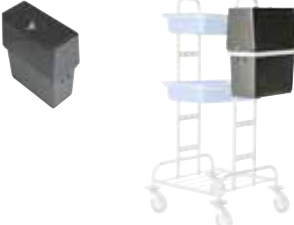



			code	pack. unit
 <p>..01 ..06</p>	<p>tray L</p> <hr/> <p>Dimensions: 68 x 36 x 10 cm (W x D x H)</p>	<p>18750..</p>	<p>1</p>	
 <p>..01 ..06</p>	<p>tray XL</p> <hr/> <p>Dimensions: 64,5 x 47 x 10 cm (W x D x H)</p>	<p>18752..</p>	<p>1</p>	
	<p>box ED</p> <p>14 l 28 l</p> <hr/> <p>Dimensions: 32,5 x 53 x 10 cm (W x D x H) Material: stainless steel Suitable for cleanroom use conditioning: autoclavable</p>	<p>151663 151661</p>	<p>1 1</p>	
	<p>lid ED</p> <hr/> <p>Material: stainless steel Suitable for cleanroom use conditioning: autoclavable for box ED</p>	<p>151665</p>	<p>1</p>	
WRINGERS				
 <p>..01 ..02 ..04 ..05</p>	<p>Twixter wringer</p>	<p>18718..</p>	<p>1</p>	
 <p>..01 ..02 ..04 ..05</p>	<p>F1 flat wringer press</p> <hr/> <p>fits all with the following articles: 10049</p>	<p>18672..</p>	<p>1</p>	

		code	pack. unit
 <p>vertical wringer VK 4</p>		18714..	1
<p>..01 ..02 ..04 ..05</p>			
 <p>F1 flat wringer ED</p> <p>Material: stainless steel Suitable for cleanroom use conditioning: autoclavable</p>		15-12180	1
 <p>wringer insert for VK 4</p>		1886510	1
 <p>wringer insert for F1</p>		1886509	1
BUCKETS / COVERS / ACCESSORIES			
 <p>bucket 6 l</p> <p>Dimensions: 17 x 27 x 22 cm (W x D x H)</p>		18756..	1
<p>..01 ..02 ..04 ..05 ..06</p>			
 <p>lid / Bucket 6 l</p>		18615..	1
<p>..01 ..02 ..04 ..05 ..06</p>			

		code	pack. unit
	grid set for buckets 6 l	1890206	1
 	bucket 8 l Dimensions: 23 x 30 x 23 cm (W x D x H)	18728..	1
 	bucket 17 l Dimensions: 31 x 32,5 x 26,5 cm (W x D x H)	18757..	1
	grid set for buckets 17 l	1890406	1
 	lid for holding frame 70 l	18789..	1
 	lid for holding frame 120 l	16499..	1

VARIANT | TOOLS – CLEANING TROLLEYS

			code	pack. unit
	<p>bucket ED 5,5 l</p> <hr/> <p>Dimensions: 16,2 x 26,5 x 20 cm (W x D x H) Material: stainless steel Suitable for cleanroom use conditioning: autoclavable</p>		151662	1
	<p>lid ED</p> <hr/> <p>Material: stainless steel Suitable for cleanroom use conditioning: autoclavable for bucket ED</p>		151664	1
CHEMICAL CENTRE				
	<p>chemical centre anthracite</p>		1658006	1
	<p>holder for chemical centre (Variant) attachment for chemical centre incl. fitting for Twixter (Variant)</p>		15181 1518114	1 1
SACS / NETS				
 	<p>Waste sac 70 l 120 l</p>		12265.. 12225..	1 1
	<p>fixation for waste sacs, yellow</p>		1876905	1

			code	pack. unit
	laundry net 20 l 40 l 70 l 120 l		12130..	10
			12160..	10
			12170..	10
			12175..	10
ACCESSORIES				
 	work schedule holder		15165..	1
 	toilet paper holder chrome-plated		10549	1
 	wire basket III		10583	1
 	piggy-back 1x120 l stainless steel chrome-plated Equipped with: with holding frame; incl. holder		15500 10500	1 1

- .01
- .02
- .03
- .04
- .05

- .01
- .05

VARIANT WITH BASE FRAME II

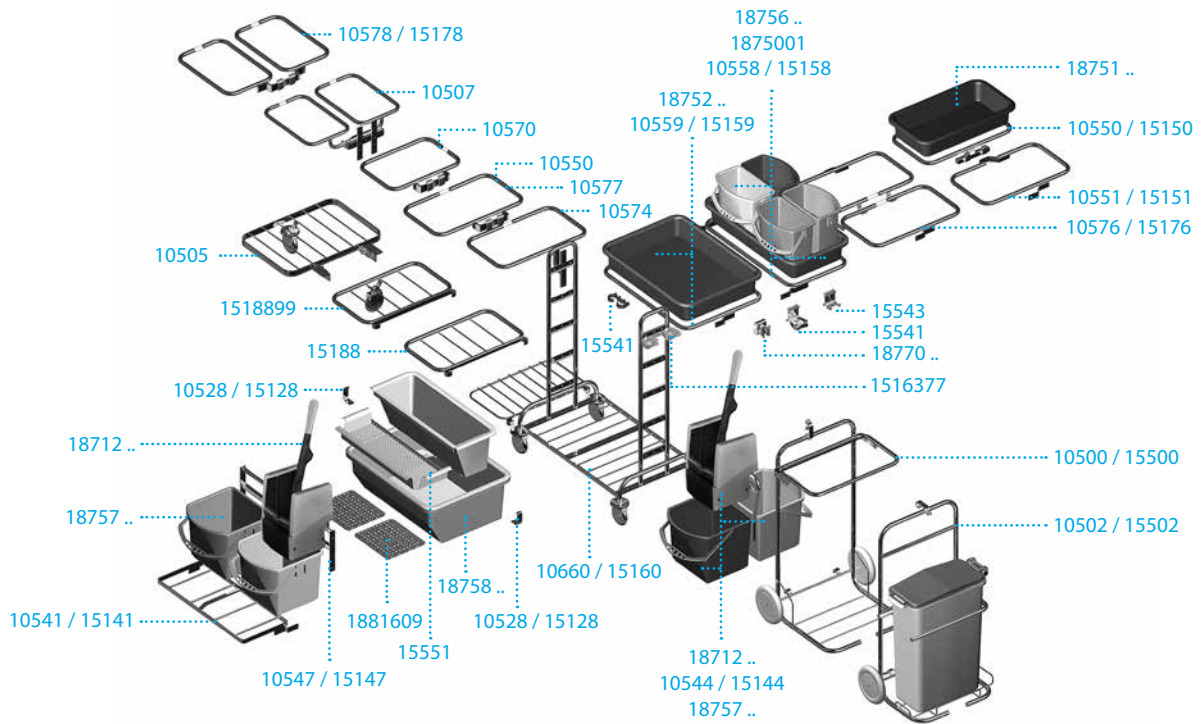

VARIANT WITH BASE FRAME III

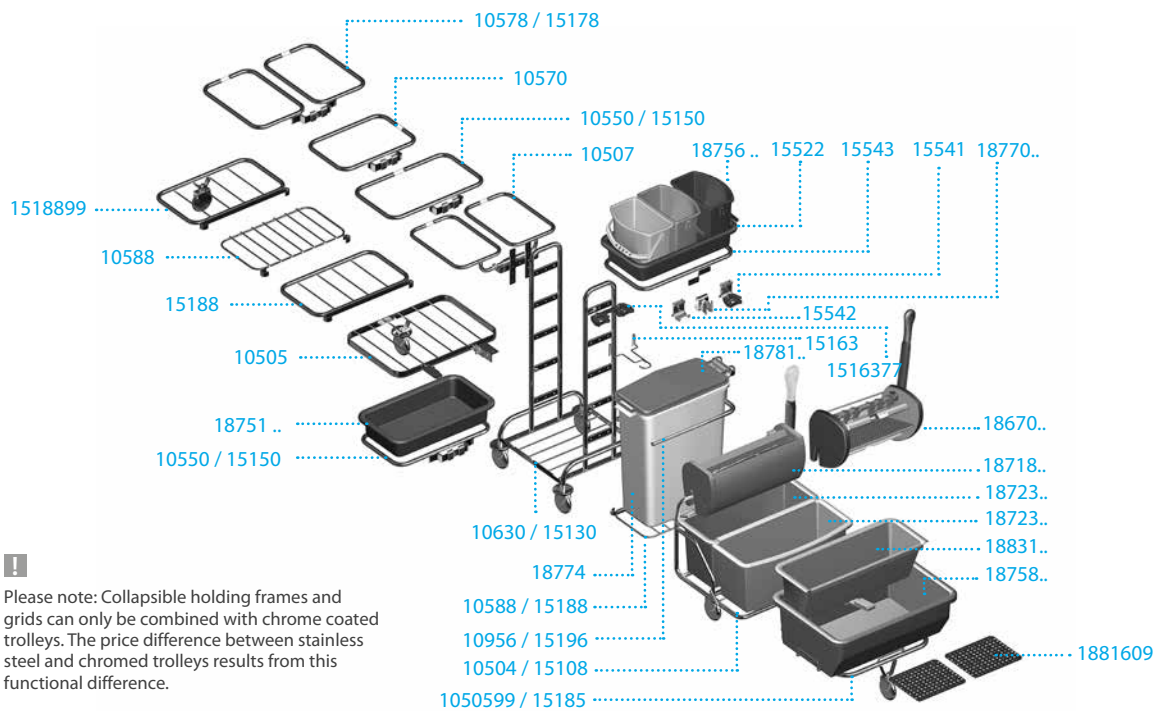

Please note: Collapsible holding frames and grids can only be combined with chrome coated trolleys. The price difference between stainless steel and chromed trolleys results from this functional difference.

Q AT A GLANCE



- **Functional and economical solution**

Storage space for essential cleaning supplies

- **Compact and sturdy**

Coated stainless steel and aluminium



TOOLS

MISTRAL

CLEANING TROLLEYS

The Mistral cleaning trolley is the economical alternative for use in medium-sized and larger premises. In addition to its sturdy workmanship in coated stainless steel and aluminium, it offers sufficient space for the most important supplies for general cleaning. The Mistral cleaning trolley is also available unassembled if required.

SITE



School / Nursery • Office / Administration • Industry

METHODS



Vertical wringer VK 4 • Des tub • Pre-Wash



Mistral Sprint

Delivery: Trolley not assembled

Description	code
Mistral Sprint	10850

Dimensions: 107 x 59 x 107 cm (W x D x H)

Set includes:

Description	code
2x box 5 l, anthracite	1646106
1x bucket 6 l, blue	1642601
1x bucket 6 l, red	1642602
1x bucket 6 l, yellow	1642605
1x bucket 17 l, blue	1641701
1x bucket 17 l, red	1641702
1x vertical wringer VK 4, red	1871402

Accessories

Description	code
holding frame for mop	1795006
equipment holder, lateral, 22 - 30 mm	1799726



Mistral Kompakt

Description	code
Mistral Kompakt	10851

Dimensions: 63 x 60 x 99 cm (W x D x H)

Set includes:

Description	code
1x bucket 6 l, blue	1642601
1x bucket 6 l, red	1642602
1x vertical wringer VK 4, red	1871402
1x bucket 17 l, red	1875702
1x lid 70 l, blue	1878901



Mistral Office

Delivery: Trolley not assembled

Description	code
Mistral Office	10852

Dimensions: 77 x 59 x 107 cm (W x D x H)

Set includes:

Description	code
2x box 5 l, anthracite	1646106
1x bucket 6 l, blue	1642601
1x bucket 6 l, red	1642602
1x bucket 6 l, green	1642604
1x bucket 6 l, yellow	1642605
1x box 15 l, anthracite	1648006

Accessories

Description	code
holding frame for mop	1795006
equipment holder, lateral, 22 - 30 mm	1799726

Mistral Des











Delivery: Trolley not assembled

Description	code
Mistral Des	10853

Dimensions: 63 x 60 x 99 cm (W x D x H)

Set includes:

Description	code
2x box 5 l, anthracite	1646106
1x bucket 6 l, blue	1642601
1x bucket 6 l, red	1642602
1x bucket 6 l, green	1642604
1x bucket 6 l, yellow	1642605
1x dosing insert for box 35 l, yellow, incl. 2 grids	1646505
1x box 35 l, anthracite	1646706

		code	pack. unit
ACCESSORIES			
 	Mistral lid Dimensions: 51 x 31,5 cm	1085906	1
 	equipment holder, lateral, 22 - 30 mm	1799726	1
 	holding frame for mop	1795006	1
SACS / NETS			
 <div style="display: flex; flex-direction: column; gap: 2px;"> <div style="background-color: blue; width: 15px; height: 10px; margin-bottom: 2px;"></div> <div style="background-color: red; width: 15px; height: 10px; margin-bottom: 2px;"></div> <div style="background-color: yellow; width: 15px; height: 10px; margin-bottom: 2px;"></div> <div style="background-color: black; width: 15px; height: 10px;"></div> </div>	Waste sac 70 l 120 l	12265.. 12225..	1 1
 	fixation for waste sacs, yellow	1876905	1
 <div style="display: flex; flex-direction: column; gap: 2px;"> <div style="background-color: blue; width: 15px; height: 10px; margin-bottom: 2px;"></div> <div style="background-color: red; width: 15px; height: 10px; margin-bottom: 2px;"></div> <div style="background-color: white; width: 15px; height: 10px; margin-bottom: 2px;"></div> <div style="background-color: green; width: 15px; height: 10px; margin-bottom: 2px;"></div> <div style="background-color: yellow; width: 15px; height: 10px;"></div> </div>	laundry net 20 l 40 l 70 l 120 l	12130.. 12160.. 12170.. 12175..	10 10 10 10

Q AT A GLANCE

- **Compact dimensions**

Compact trolley suitable for stairs

- **Timelessly classic model**

Basic equipment for waste disposal and wet cleaning



TOOLS

VARIETTA

CLEANING TROLLEYS

The compact Varietta cleaning trolley is just the right solution for all areas of use where space is cramped. Its suitability for stairs and its compact size gives it a particularly large radius of action. The trolley is especially well suited to difficult terrain such as cinemas or lecture theatres. Compared to the basic fittings, the Varietta Plus 2 is chromed and has a wringer and two buckets for the hygienic separation of clean water and used water. The additional grid with supporting wheel below the disposal unit stabilises the trolley even when it is carrying large quantities of waste.

AREAS OF APPLICATION

- Stairs

SITE



Small areas (Shop, Doctors' surgeries)

METHODS



Vertical wringer VK 4



Varietta (chrome coated)

Description	code
Varietta (chrome coated)	10637

Dimensions: 72 x 52 x 118 cm (W x D x H)

Set includes:

Description	code
1x base trolley Varietta, chrome coated	10460
1x vertical wringer VK 4, red	1871402
1x stick attachment, stainless steel	15541
1x holding frame 120 l, chrome coated	10535
1x holding frame, chrome-plated	10531
1x tray M, blue	1875101
1x bucket 6 l, blue	1875601
1x bucket 6 l, red	1875602
1x bucket 17 l, red	1875702











Varietta Plus 2 (chrome coated)













Description	code
Varietta Plus 2 (chrome coated)	10639

Dimensions: 72 x 66 x 120 cm (W x D x H)











Set includes:

Description	code
1x base trolley Varietta Plus, chrome coated	10470
1x vertical wringer VK 4, red	1871402
1x stick attachment, stainless steel	15541
1x holding frame 120 l, chrome coated	10535
1x wringer holder, rigid, Varietta	10527
1x holding frame, chrome-plated	10531
1x storage frame incl. support wheel	10585
1x tray M, blue	1875101
1x bucket 6 l, blue	1875601
1x bucket 6 l, red	1875602
1x bucket 17 l, blue	1875701
1x bucket 17 l, red	1875702





		code	pack. unit	
BASE FRAMES				
	base trolley Varietta, chrome coated	10460	1	
	base trolley Varietta Plus, chrome coated	10470	1	
HOLDING FRAMES				
		holding frame 70 l, chrome coated	10530	1
		holding frame 120 l, chrome coated	10535	1
		holding frame 2 x 70 l, chrome coated, Varietta	10537	1
		holding frame 2 x 20 l for hook-up on holding frame 2 x 70 l	15527	1

		code	pack. unit
		holding frame 1 x 40 l for hook-up on holding frame 2 x 70 l	15525 1
		holding frame for 2 x tray, chrome coated, Varietta for tray M	10532 1
		holding frame chrome-plated for tray M	10531 1
GRID			
		storage frame incl. support wheel	10585 1
		storage frame for Varietta	10780 1
MATERIAL ATTACHMENT			
		stick attachment, stainless steel	15541 1

			code	pack. unit
		attachment incl. 2 hooks, stainless steel	15543	1
TRAY				
		tray M Dimensions: 51 x 32 x 9 cm (W x D x H)	18751..	1
				
WRINGERS				
		vertical wringer VK 4	18714..	1
				
		wringer insert for VK 4	1886510	1
BUCKETS / COVERS / ACCESSORIES				
		bucket 6 l Dimensions: 17 x 27 x 22 cm (W x D x H)	18756..	1
				
	grid set for buckets 6 l		1890206	1

		code	pack. unit
		<p>bucket 17 l</p> <hr/> <p>Dimensions: 31 x 32,5 x 26,5 cm (W x D x H)</p>	<p>18757.. 1</p>
<p>..01 ..02</p>			
		<p>grid set for buckets 17 l</p>	<p>1890406 1</p>
SACS / NETS			
<p>..01 ..02 ..05 ..06</p>		<p>Waste sac 70 l 120 l</p>	<p>12265.. 1 12225.. 1</p>
		<p>fixation for waste sacs, yellow</p>	<p>1876905 1</p>
<p>..01 ..02 ..03 ..04 ..05</p>		<p>laundry net 20 l 40 l 70 l 120 l</p>	<p>12130.. 10 12160.. 10 12170.. 10 12175.. 10</p>
ACCESSORIES			
		<p>wringer holder, rigid, chrome coated, Varietta</p>	<p>10527 1</p>

VARIETTA | TOOLS – CLEANING TROLLEYS

			code	pack. unit
		lid for holding frame 70 l	18789..	1
<ul style="list-style-type: none"> .01 .02 .05 .06 				
		lid for holding frame 120 l	16499..	1
<ul style="list-style-type: none"> .01 .02 .05 .06 				

Q AT A GLANCE



- **Maximum overview**
Quick access to all the material on board
- **Highly manoeuvrable**
Flexible manoeuvring even in tight corners



TOOLS

AQUVAVIZ

CLEANING TROLLEYS

The compact AquvaVIZ is a versatile and particularly practical system for general cleaning and waste disposal. Even more possibilities are opened up by the modular extension options – for example for supplies or for surface cleaning. The system proves its superiority particularly in small premises of up to 200 sqm and where space is tight.

SITE



Small areas (Shop, Doctors' surgeries)

METHODS



Vertical wringer VK 4 • Des tub • Pre-Wash • Dry cleaning



AquavaVIZ Press

Equipped with the VK 4 wringer, the AquavaVIZ Press is ideal for use for the one-step wet mopping method: The trolley is very stable and the wringer operation particularly ergonomic.

Description	code
AquavaVIZ Press	10350

Dimensions: 62 x 40 x 92 cm (W x D x H)

Set includes:

Description	code
1x double bucket cleaning trolley	10325
1x vertical wringer VK 4, yellow	1871405
1x grid AquavaVIZ, stainless steel	10720
1x adapter for steel bars (set)	10935
1x stainless steel structure with 1 x 70 l holding frame and 2 hooks, 2 holders for 6 l buckets at the sides	10725
1x frame for wringer press VK 4 AquavaVIZ, stainless steel	10723
1x equipment holder	18797
1x bucket 17 l, red	1875702

AquavaVIZ Moboxx

The Aquaviz Moboxx allows hygienic storage and transportation of prepared mops ready to be used on site. The 70 l holding frame can also be fitted with a waste sac, and the frame also offers two hooks for accessories and space, for two Tuboxxes for hygienic transportation of cloths.

Description	code
AquavaVIZ Moboxx	10370

Dimensions: 62 x 58 x 92 cm (W x D x H)

Set includes:

Description	code
1x double bucket cleaning trolley	10325
1x attachment for Moboxx, stainless steel	10721
1x adapter for steel bars (set)	10935
1x stainless steel structure with 1 x 70 l holding frame and 2 hooks, 2 holders for 6 l buckets at the sides	10725
1x equipment holder	18797
2x Moboxx anthracite with clip yellow	1863005



AquavaVIZ Wringboy

The AquavaVIZ can also be equipped with the Wringboy. The compact bucket sits firmly and securely on the base frame. Thanks to the integrated wringer, the Wringboy is ideal when it comes to fast and labour-saving cleaning of small areas.

Description	code
AquavaVIZ Wringboy	10340

Dimensions: 62 x 40 x 92 cm (W x D x H)

Set includes:

Description	code
1x double bucket cleaning trolley	10325
1x Wringboy	19590
1x grid AquavaVIZ, stainless steel	10720
1x adapter for steel bars (set)	10935
1x stainless steel structure with 1 x 70 l holding frame and 2 hooks, 2 holders for 6 l buckets at the sides	10725
1x equipment holder	18797

AquavaVIZ Twixter Des







The AquavaVIZ with Des tub module is a small trolley for disinfectant cleaning. For hospitals, as a small operating theatre trolley or in health facilities, this trolley is ideal for the cleaning business.















Description	code
AquavaVIZ Twixter Des	10320VI





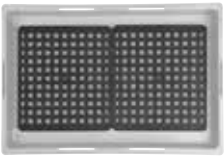

Dimensions: 62 x 73 x 92 cm (W x D x H)

Set includes:













Description	code
1x double bucket cleaning trolley	10325
1x dosing insert for box 35 l, yellow, incl. 2 grids	1646505
1x stick attachment, stainless steel	15541
1x adapter for steel bars (set)	10935
1x attachment for box 35 l, stainless steel	1072835
1x stainless steel structure with 1 x 70 l holding frame and 2 hooks, 2 holders for 6 l buckets at the sides	10725
1x tray M, anthracite	1875106
1x box 35 l, anthracite	1646706

		code	pack. unit
BASE FRAME			
	double bucket cleaning trolley	10325	1
HOLDING FRAMES			
	stainless steel structure with 1 x 70 l holding frame and 2 hooks, 2 holders for 6 l buckets at the sides	10725	1
	holding frame 2 x 20 l	15527	1
	for hook-up on holding frame 2 x 70 l		
	holding frame 1 x 40 l	15525	1
	for hook-up on holding frame 2 x 70 l		
GRID			
	grid AquavaVIZ, stainless steel	10720	1
	attachment for Mobox, stainless steel	10721	1

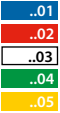
		code	pack. unit	
MATERIAL ATTACHMENT				
		stick attachment, stainless steel	15541	1
		equipment holder	18797	1
TUBS / TRAYS				
		<p>tray M</p> <hr/> <p>Dimensions: 51 x 32 x 9 cm (W x D x H)</p>	18751..	1
				
		<p>tray L</p> <p>anthracite</p> <hr/> <p>Dimensions: 68 x 36 x 10 cm (W x D x H)</p>	1875006	1
				
		Moboxx, anthracite with coloured clips	18630..	1
				
		grid for boxes 15 l / 35 l (set)	1881609	1

		code	pack. unit
	lid for Moboxx with seal	1864506	1
WRINGERS			
	vertical wringer VK 4	18714..	1
<ul style="list-style-type: none"> ..01 ..02 ..04 ..05 			
	wringer insert for VK 4	1886510	1
	box 35 l, anthracite	1646706	1
	Dimensions: 35 x 50 x 30 cm (W x D x H)		
	dosing insert for box 35 l, yellow, incl. 2 grids	1646505	1
	Wringboy bucket incl. wringer	19590	1

		code	pack. unit
BUCKET / COVERS			
 	bucket 6 l Dimensions: 17 x 27 x 22 cm (W x D x H)	18756..	1
 	lid / Bucket 6 l	18615..	1
	grid set for buckets 6 l	1890206	1
 	bucket 17 l Dimensions: 31 x 32,5 x 26,5 cm (W x D x H)	18757..	1
	grid set for buckets 17 l	1890406	1
 	lid for holding frame 70 l	18789..	1

		code	pack. unit
SACS / NETS			
	Waste sac		
	70 l	12265..	1
	120 l	12225..	1
			
<hr/>			
		fixation for waste sacs, yellow	1876905
			
<hr/>			
	laundry net		
	20 l	12130..	10
	40 l	12160..	10
	70 l	12170..	10
	120 l	12175..	10
			
ACCESSORIES			
		driving handle	10730
<hr/>			
		pocket bag for AquvaVIZ, anthracite	18600
			
<hr/>			
		adapter for steel bars (set)	10935

		code	pack. unit
	attachment for box 35 l , stainless steel	1072835	1
	frame for wringer press VK 4 AquvaVIZ, stainless steel	10723	1

OVERVIEW

- **Classic double trolley**
for cleaning in heavily soiled areas
- **Small and manouverable**
Plastic base with stainless steel strut



TOOLS

WET MOP TROLLEYS

CLEANING TROLLEYS

VERMOP offers an extensive professional range for wet cleaning of hard floors. Geared for practical application, the range facilitates quick, simple and economic wet cleaning – in premises of all conditions. Functional buckets, sturdy wringers and long-lasting, durable trolleys form the key components, which our customers have been appreciating for years.

SITE



Small areas (Shop, Doctors' surgeries)

METHODS



Twixter-Press • F1 flat wringer • Vertical wringer VK 4



wet mop trolley Twixter, stainless steel

With the unique Twixter concept featuring the double-sided Twixter mop, the surface coverage of the mop can be significantly increased. The Twixter wet mop trolley is made from a stainless steel. Two 20 l tubs ensure hygienic separation of used and clean water. The ergonomic Twixter wringer with lockable wringer lever facilities labour-saving mop wringing. As an optional extra, the drawbar of the Twixter II wet mop trolley can also be equipped with two 6 l buckets, for hygienic surface cleaning or for transporting cleaning materials.

Description	code
wet mop trolley Twixter, stainless steel	10432

Dimensions: 55 x 65 x 97 cm (W x D x H)

Set includes:

Description	code
1x base frame Twixter / F1, incl. swivel connector, stainless steel	10402
1x Twixter wringer, yellow	1871805
1x tub 20 l, yellow	1872405
1x tub 20 l, anthracite	1872306

wet mop trolley Twixter 2, stainless steel

Description	code
wet mop trolley Twixter 2, stainless steel	1043299

Dimensions: 65 x 65 x 97 cm (W x D x H)

Set includes:

Description	code
1x base frame Twixter II, for 2 buckets 6 l, incl. swivel connector	1040299
1x Twixter wringer, yellow	1871805
1x tub 20 l, yellow	1872405
1x tub 20 l, anthracite	1872306
1x bucket 6 l, blue	1875601
1x bucket 6 l, red	1875602



wet mop trolley F1, stainless steel

The F1 wet mop trolley with the flat wringer F1 is used in combination with the Sprint floor mopping system. The Sprint flat mops can be rinsed and wrung out directly on the holder, hygienically and in a time-saving way. Trolley and wringer are made of high-quality stainless steel. Two 20 l tubs ensure the hygienic separation of dirty water and fresh water.

Description	code
wet mop trolley F1, stainless steel	15070
Dimensions: 55 x 65 x 97 cm (W x D x H)	

Set includes:

Description	code
1x base frame Twixter / F1, incl. swivel connector, stainless steel	10402
1x tub 20 l, yellow	1872405
1x tub 20 l, anthracite	1872306
1x F1 flat wringer press, yellow	1867205



Garant wet mop trolley, 2 x 17 l, stainless steel

It is stainless steel which makes the Garant so solid and durable. With just one bucket and a VK 4 wringer, it takes up virtually no space when stored. Ideally suited for transport by car, for example to lock-up premises. For wet mopping using the 2-bucket method with the separation of clean and dirty water, the Garant is also available as a 2 x 17 l version with driving handle.

Description	code
Garant wet mop trolley, 2 x 17 l, stainless steel	10423
Dimensions: 74 x 41 x 88 cm (W x D x H)	

Set includes:

Description	code
1x base frame Garant 2 x 17 l, stainless steel	10419
1x vertical wringer VK 4, red	1871402
1x bucket 17 l, blue	1875701
1x bucket 17 l, red	1875702



Aquava wet mop trolley, 2 x 17 l

The Aquava wet cleaning trolleys with 75mm swivel castors easy to manoeuvre and made from high tensile plastic. The low weight construction and long service life are enhanced by the option of having two buckets and a driving handle or one bucket using the wringer handle to push the trolley.

Description	code
Aquava wet mop trolley, 2 x 17 l	1614392

Dimensions: 104 x 40 x 85 cm (W x D x H) | Base frame with 2 in-built connectors/stabilizers, man-made material.

Mistral wet mop trolley, 2 x 17 l, chrome coated

Description	code
Mistral wet mop trolley, 2 x 17 l, chrome coated	1044392

Dimensions: 73 x 41 x 90 cm (W x D x H)



Aqua wet mop trolley, 1 x 17 l

Description	code
Aqua wet mop trolley, 1 x 17 l	10348
Dimensions: 50 x 40 x 84 cm (W x D x H)	

Aqua wet mop trolley, 1 x 17 l + 1 x 6 l

Description	code
Aqua wet mop trolley, 1 x 17 l + 1 x 6 l	10349
Dimensions: 50 x 40 x 84 cm (W x D x H)	



Mistral wet mop trolley, 1 x 17 l, chrome coated

The Mistral with four 75 mm swivel castors is available with the VK 4 wringer in various versions – depending on requirements, with or without driving handle. It is equipped with either one or two buckets, with 17 or 25 litre capacity. Tell us how you plan to use it, and we will be pleased to advise you on selecting the best solution.

Description	code
Mistral wet mop trolley, 1 x 17 l, chrome coated	10448

Dimensions: 49 x 41 x 90 cm (W x D x H)

Cascade 2 wet mop trolley



When work is to be carried out on a number of different floors at the same time, the Cascade, with its stair-climbing capability, is the right trolley. With the buckets and wringer aligned above one another, stairs are no obstacle. The vertical construction also allows mop covers to be wrung out without bending.





Description	code
Cascade 2 wet mop trolley	10482





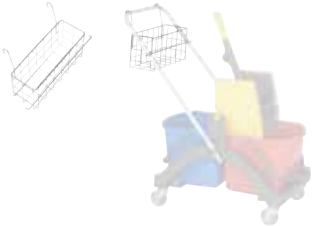
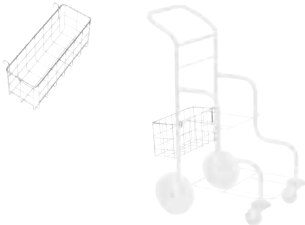

Dimensions: 71 x 46 x 113 cm (W x D x H)





Set includes:

Description	code
1x base trolley Cascade 2	10412
1x vertical wringer VK 4, red	1871402
1x bucket 17 l, blue	1875701
1x bucket 17 l, red	1875702

		code	pack. unit
BASE FRAMES			
	base frame Twixter / F1, incl. swivel connector, stainless steel Dimensions: 55 x 65 x 97 cm (W x D x H)	10402	1
	base frame Twixter II, for 2 buckets 6 l, incl. swivel connector Dimensions: 65 x 65 x 97 cm (W x D x H)	1040299	1
	base trolley Cascade 2 Dimensions: 71 x 46 x 113 cm (W x D x H)	10412	1
	base frame Garant 2 x 17 l, stainless steel Dimensions: 74 x 41 x 88 cm (W x D x H)	10419	1
ACCESSORIES			
	swivel connector for wet mop trolley plastic	10392	1
	swivel connector for wet mop trolley plastic 1 x 17 l	10391	1
	swivel connector for Mistral / Garant	10492	1

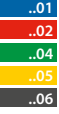
		code	pack. unit
	push bar incl. attachment for 2 x 6 l buckets, for base frame Twixter II	10499	1
	wire basket IX	1052592	1
	wire mesh basket VI, for wet mop trolley 1 x 17 l and 1 x 25 l	10525	1
	attachment for wire mesh basket for Twixter / F1 wet mop trolley	15140	1
WRINGERS			
	Twixter wringer	18718..	1
<ul style="list-style-type: none"> ..01 ..02 ..04 ..05 			
	F1 flat wringer press	18672..	1
<ul style="list-style-type: none"> ..01 ..02 ..04 ..05 	fits all with the following articles: 10049		

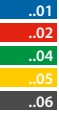
			code	pack. unit
 <p>..01 ..02 ..04 ..05</p>	<p>vertical wringer VK 4</p>	<p>18714..</p>	<p>1</p>	
	<p>wringer insert for VK 4</p>	<p>1886510</p>	<p>1</p>	
	<p>wringer insert for F1</p>	<p>1886509</p>	<p>1</p>	
BOXES				
	<p>box 20 l, anthracite, for hook-up</p>	<p>1792006</p>	<p>1</p>	
TUBS				
 <p>..01 ..05</p>	<p>tub 20 l</p> <p>volume: 20 l combination only possible with 1 x tub 8724.. and 1 x tub 8723..</p>	<p>18724..</p>	<p>1</p>	
 <p>..02 ..06</p>	<p>tub 20 l</p> <p>volume: 20 l combination only possible with 1 x tub 8724.. and 1 x tub 8723..</p>	<p>18723..</p>	<p>1</p>	

		code	pack. unit
BUCKETS			
 	bucket 6 l Dimensions: 17 x 27 x 22 cm (W x D x H)	18756..	1
 	lid / Bucket 6 l	18615..	1
 	bucket 17 l Dimensions: 31 x 32.5 x 26.5 cm (W x D x H)	18757..	1

Q OVERVIEW



- **Long-living and robust**
available in different variations
- **For large quantities of waste**
allowing comfortable transportation over large distances



PAPER- AND DISPOSAL TROLLEY

CLEANING TROLLEYS

The range of VERMOP supply and disposal trolleys are ideal for task simplification in all areas with large amounts of laundry. They are low maintenance and can be equipped and refitted as required. And you can rely on them – they have been proving their durability for years.

SITE



School / Nursery • Office / Administration



Meditrans laundry collector single

Description	code
Meditrans laundry collector single	10641

Dimensions: 39 x 46 x 96 cm (W x D x H) | 75 mm wheels

Meditrans laundry system single

Description	code
blue	10641801
red	10641802
green	10641804
yellow	10641805

Dimensions: 39 x 46 x 96 cm (W x D x H) | with lid and pedal, without sac, wheels 75 mm



Meditrans laundry collector double

Description	code
Meditrans laundry collector double	10642

Dimensions: 73 x 46 x 96 cm (W x D x H) | 75 mm wheels



Meditrans laundry collector double

Description	code
Meditrans laundry collector double	10642802

Dimensions: 73 x 46 x 96 cm (W x D x H) | incl. 2 lids (colours to be selected) and pedal, without sac, wheels 75 mm



Meditrans laundry collector triple







Description	code
Meditrans laundry collector triple	10643





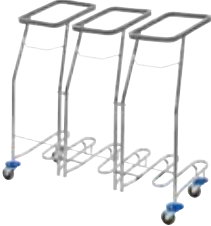

Dimensions: 108 x 46 x 96 cm (W x D x H) | 75 mm wheels

Meditrans laundry collector triple

Description	code
Meditrans laundry collector triple	10643802

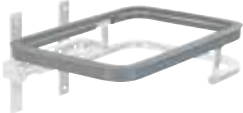
Dimensions: 108 x 46 x 96 cm (W x D x H) | incl. 3 lids (colours to be selected) and pedal, without sac, wheels 75 mm

MODELLE		code	pack. unit
	<p>Meditrans laundry collector single</p> <hr/> <p>Dimensions: 39 x 46 x 96 cm (W x D x H) 75 mm wheels</p>	10641	1
	<p>Meditrans laundry system, single</p> <p>blue red green yellow</p> <hr/> <p>Dimensions: 39 x 46 x 96 cm (W x D x H) with lid and pedal, without sac, wheels 75 mm</p>	10641801 10641802 10641804 10641805	1 1 1 1
	<p>Meditrans laundry collector double</p> <hr/> <p>Dimensions: 73 x 46 x 96 cm (W x D x H) 75 mm wheels</p>	10642	1
	<p>Meditrans laundry collector double</p> <hr/> <p>Dimensions: 73 x 46 x 96 cm (W x D x H) incl. 2 lids (colours to be selected) and pedal, without sac, wheels 75 mm</p>	10642802	1
	<p>Meditrans laundry collector triple</p> <hr/> <p>Dimensions: 108 x 46 x 96 cm (W x D x H) 75 mm wheels</p>	10643	1
	<p>Meditrans laundry collector triple</p> <hr/> <p>Dimensions: 108 x 46 x 96 cm (W x D x H) incl. 3 lids (colours to be selected) and pedal, without sac, wheels 75 mm</p>	10643802	1

		code	pack. unit
ACCESSORIES			
 	lid for laundry collector	18777..	1
	spare rubber ring	18872	1
	wall holder collapsible	10503	1
	conversion kit for laundry collector for expansion of Meditrans-modules	18870	1
 	laundry sac, white, coloured stripes	12142..	1

- .01
- .02
- .04
- .05

- .01
- .02
- .04
- .05
- .08

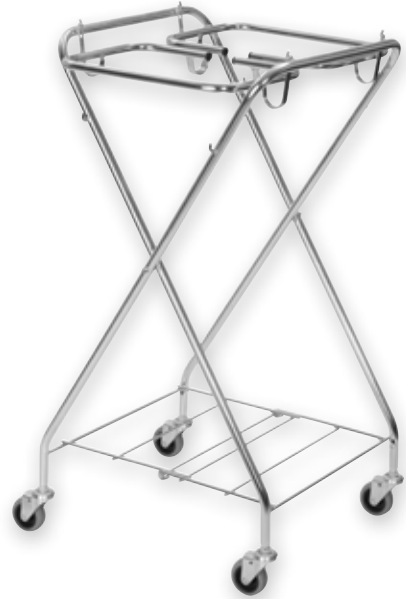
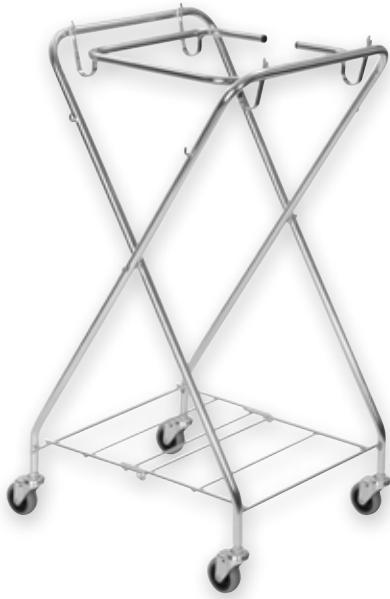

paper trolley X-Form

Thanks to its foldable construction, the high-gloss zinc-plated base frame of the X-form paper trolley with four 75 mm castors requires very little storage space. Expanded, it permits the attachment of one 120 l waste sac or 2 x 70 l, depending on the model. A grid provides stability when the sacs are full.

Description	code
paper trolley X-Form	1051022

Dimensions: 56 x 56 x 104 cm (W x D x H) | base trolley, 75 mm wheels, galvanized, polished finish, incl. holding frame 120 l

paper trolley X-Form

Description	code
paper trolley X-Form	1051017

Dimensions: 56 x 56 x 104 cm (W x D x H) | base trolley, 75 mm wheels, galvanized, polished finish, incl. holding frame 2 x 70 l









waste and transport trolley

With the waste and transport trolley, refuse or other materials (e.g. used mops) can be transported comfortably even over long distances. The two large 180 mm light castors ensure ease of movement - even over stairs and thresholds. The trolley can be equipped with two different holding frames for 1 x 120 l or 2 x 70 l waste sacs.

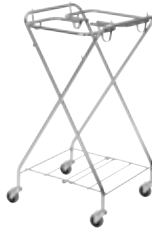



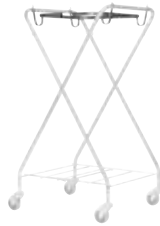



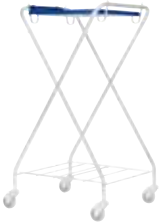

Description	code
waste and transport trolley	10516

Dimensions: 57 x 47 x 96 (W x D x H) | base trolley galvanized, incl. 2 wheels 185 mm without holding frame

PAPER- AND WASTE DISPOSAL TROLLEY | TOOLS – CLEANING TROLLEYS

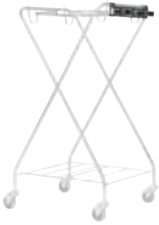
		code	pack. unit	
MODELLE				
	<p>paper trolley X-Form</p> <hr/> <p>Dimensions: 56 x 56 x 104 cm (W x D x H) base trolley, 75 mm wheels, galvanized, polished finish, incl. holding frame 120 l</p>	1051022	1	
	<p>paper trolley X-Form</p> <hr/> <p>Dimensions: 56 x 56 x 104 cm (W x D x H) base trolley, 75 mm wheels, galvanized, polished finish, incl. holding frame 2 x 70 l</p>	1051017	1	
	<p>waste and transport trolley</p> <hr/> <p>Dimensions: 57 x 47 x 96 (W x D x H) base trolley galvanized, incl. 2 wheels 185 mm without holding frame</p>	10516	1	
ACCESSORIES				
	<p>base trolley, waste paper collection, zinc coated, polished finish</p> <hr/> <p>Dimensions: 56 x 56 x 104 cm (W x D x H)</p>	10510	1	
		holding frame 2 x 70 l	1052277	1
		holding frame 1 x 120 l	10522	1

TOOLS – CLEANING TROLLEYS | PAPER- AND WASTE DISPOSAL TROLLEY

			code	pack. unit
		holding frame 70 l, chrome coated holding frame 120 l, chrome coated	10530 10535	1 1
		lid 120 l, blue	1879301	1
		pocket bag for paper trolley	18800	1
		four-fold equipment holder	10523	1
		supporting grid for mop holder for paper trolley	18794	1
		jute sac (4 eyelets) 190 l	18802	1

PAPER- AND WASTE DISPOSAL TROLLEY | TOOLS – CLEANING TROLLEYS

		code	pack. unit
	polypropylene sac 120 l, with cord	18825	1
	polypropylene sac (4 eyelets) 190 l	18803	1





 TOOLS

FLOOR CLEANING SYSTEMS

SYSTEMATIC SUCCES

Combine the different VERMOP mop qualities with our huge range of floor cleaning systems. For example, the double-sided Twixter system or the Scandic Velcro mop system for dry floor cleaning. All systems were developed together with our customers based on many years of practical experience. The holders and accessory parts are made of high-quality metals and plastics which stand up to the highest demands of the everyday cleaning business.

TWIXTER / TWIX



- Double-sided system for smart and economical 2-phase cleaning to meet the highest standards.

Combinable cleaning methods



Twixter-Press • Des tub • Pre-Wash • Dry cleaning • Spray method • Pour method

SPRINT



- Flat mop system, simple and convenient to use with large selection of mops and accessories.

Combinable cleaning methods



F1 flat wringer • Vertical wringer VK 4 • Des tub • Pre-Wash • Dosing sieve • Dry cleaning • Spray method • Pour method

SCANDIC DUO



- Double-sided Velcro mop system for dry floor cleaning with the most modern microfibre technology.

Combinable cleaning methods



Dry cleaning

SCANDIC MONO



- Single-sided Velcro mop system for wet, damp and dry floor cleaning on all surface areas.

SPRINT PLUS



- Flat mop system, simple and convenient to use with large selection of mops and accessories.

CLIPPER



- Proven alternative, tested time and again in everyday use, for cleaning heavily-soiled surfaces.

DAMP MOP



- Fast and effective dry and damp floor cleaning for large areas.

AQUVA



- Classic wet cleaning system for heavily-soiled premises with heavy traffic.



FLOOR CLEANING



TOOLS

MOP QUALITIES

QUALITY AND DIVERSITY

Choose exactly the right mop for your requirements from a diverse range. Depending on the area of use, floor covering, degree of soiling, cleaning chemicals and frequency of washing, it makes sense to combine various fibres to achieve an the best cleaning results.

TRONIC



Application
Damp cleaning, wet cleaning

Material*
22 % Cotton
78 % Polyester /
Microfibre

Care instructions
95°C/200°F 

- High-end product made of high-quality materials
- Optimum dirt removal thanks to microfibre combined with good water absorption
- Removes hair very successfully
- All-rounder, suitable for different areas of use

WHITE MAGIC

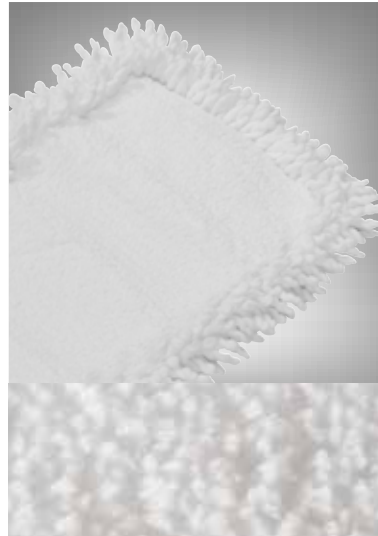

Application
Damp cleaning, wet cleaning

Material*
100 % Polyester /
Microfibre

Care instructions
95°C/200°F 

- High-quality microfibre for very good dirt-carrying capacity
- Additional top sheet acting as moisture depot
- Wet and damp cleaning, particularly on structured floors
- Ideal for stoneware tiles

CERAN



Application
Dry cleaning

Material*
100 % Microfibre

Care instructions
95°C/200°F 

- Cleaning without raising dust due to electrostatic charge
- High level of dirt removal
- No bacterial contamination as used without water
- Dry floor cleaning, ideal for occasional or pre-cleaning of moisture-sensitive floors

*Relates to inner fringe, Sprint 40 cm

CLASSIC



Material*

65 % Polyester / 35 % Cotton

- Resistant to cleaning agents
- Good water absorption and gliding properties
- Ideally suited to general cleaning with high level of cleaning agent use
- Ideal for disinfectant cleaning

ANTIBAK



Material*

65 % Polyester / 35 % Cotton

- Special fibre treatment for antibacterial effect
- Prevents bacterial contamination
- Disinfectant cleaning, e.g. in hospitals, nursing homes

BLUE

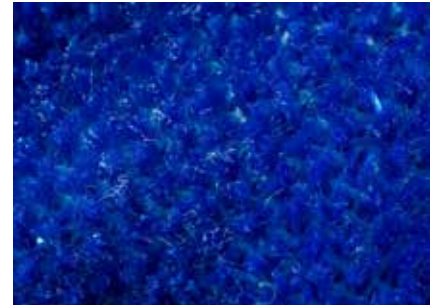

Material*

100 % Brush material

- Abrasive material for optimum mechanical dirt removal
- Ideal in combination with White Magic
- Deeply structured stone floors, such as safety tiles in kitchens, sanitation facilities and bathrooms

BRUSH



Material*

35 % polyester
55 % polyester / microfibre
10 % polyamide

- Outstanding dirt loosening and removal
- Good gliding properties on safety tiles
- Bristle strips also clean grouting thoroughly
- Wet cleaning of heavily structured and rough floor covering
- High quality finish with additional top sheet

BASIC



Material*

50 % Cotton / 50 % Polyester

- Particularly good water absorption
- High level of dirt removal
- For damp and wet general cleaning

TRONIC LIGHT



Material*

20 % Cotton
80 % Polyester / Microfibre

- Particularly good water absorption
- For general cleaning

*Relates to inner fringe, Sprint 40 cm

BRUSH PROGRESSIVE



Material*

82 % polyester
18 % polyamide

- Good dirt removal
- Good gliding properties on safety tiles
- Bristle strips also clean grouting
- Good rinsing properties

PROGRESSIVE



Material*

100 % Microfibre

- Particularly good water absorption
- For general cleaning
- Available for the Sprint system speckled in red and blue

BASIC LIGHT



Material*

50 % Cotton
50 % Polyester

- Economical alternative to Basic
- Good water absorption
- Good dirt removal
- For damp and wet general cleaning

LAUNDRY RECOMMENDATIONS

Wash separately. This prevents the various fibre qualities damaging one another. Do not use a fabric softener!

MOP QUALITIES	Maximum laundering temperature	Maximum drying temperature	Bleaching
TRONIC, TRONIC LIGHT			
WHITE MAGIC			
CERAN			
BRUSH			
BRUSH PROGRESSIVE			
CLASSIC, BASIC, BASCI LIGHT			
ANTIBAK			
BLUE, RED			
PROGRESSIVE			



TOOLS METHODS

THE RIGHT SOLUTION OF EVERY REQUIREMENT

Choose the right cleaning method depending on the premises, floor covering or degree of soiling. Wringers, Des tubs and pre-wash boxes are tailored to the individual VERMOP floor-cleaning systems and can be combined with a large number of the VERMOP cleaning trolleys.

In order to ensure that wringers, boxes and all other accessories can stand up to the rough and tumble of everyday cleaning, they are made of high-quality plastic and metals.

PRE-WASH

- Suitable for 1-phase wet cleaning
- Central preparation of the mop
- Saves water and cleaning chemicals
- No spreading of germs
- Ergonomic attachment straight from the box
- Simple handling
- No disposal of cleaning liquid necessary

Compatible floor cleaning systems

Twixter • Twix • Sprint • Scandic Mono 40 cm

Compatible cleaning trolley

Equipe • Shopster • Variant • AquavaVIZ



DES TUB

- Suitable for 2-phase wet and dry cleaning with Twixter / Twix
- Controlled moistening of one side of mop cover
- No contamination of cleaning solution
- No spreading of germs
- Simple handling

Compatible floor cleaning systems

Twixter 40 cm • Twix 30 cm • Sprint 40 cm • Scandic Mono 40 cm

Compatible cleaning trolley

Equipe • Shopster • Variant • AquavaVIZ



DOSING SIEVE



- Suitable for classic cover-change method
- Mop is soaked in cleaning solution
- The mop is rested on the dosing sieve to allow excess cleaning solution to run off
- No contamination of cleaning solution

Compatible floor cleaning systems

Sprint • Scandic Mono

Compatible cleaning trolley

Variant

POUR METHOD



- Cleaning solution is poured over the attached mop or, where applicable through the holder (Sprint)
- No contamination of cleaning solution
- No spreading of germs
- Simple handling
- Removes the need to dispose of used cleaning solution
- Area-specific dosing

Compatible floor cleaning systems

Twixter 40 cm • Twix 30 cm • Sprint • Clipper • Scandic Mono

Compatible cleaning trolley

Equipe • Shopster • Variant • AquvaVIZ

DRY CLEANING



- Effective removal of loose dirt and dust
- Ideal for pre-cleaning or for polished or coated floor coverings
- No need to use cleaning solution
- Dirt is bound to the fibres

Compatible floor cleaning systems

Twixter 40 cm • Twix 30 cm • Sprint • Scandic Mono • Scandic Duo • Damp mop

Compatible cleaning trolley

Equipe • Shopster • Variant • AquvaVIZ

SPRAY METHOD



- Ideal for removing spot soiling
- Suitable for cleaning stairs
- Distribution of cleaning solutions through pump atomizer
- No direct skin contact with the cleaning solution
- No contamination of cleaning solution
- Removes the need to dispose of used cleaning solution

Compatible floor cleaning systems

Twixter 40 cm • Twix 30 cm • Sprint • Clipper • Damp mop

Compatible cleaning trolley

Equipe • Shopster • Variant • AquvaVIZ

TWIXTER-PRESS / TWIX-PRESS



- Suitable for 1-phase wet cleaning
- Wringing without removing the mop from the holder
- No direct skin contact

Compatible floor cleaning systems

Twixter 40 cm • Twix 30 cm

Compatible cleaning trolley

Twixter 40 cm: Equipe • Variant • Wet mop trolley
Twix 30 cm: Shopster • Wet mop trolley

F1 FLAT WRINGER



- Suitable for 1-phase wet cleaning
- Made of high-quality stainless steel
- Robust and durable
- Wringing without removing the mop from the holder
- No direct skin contact

Compatible floor cleaning systems

Sprint V

Compatible cleaning trolley

Equipe • Variant • Wet mop trolley

VERTICAL WRINGER VK 4



- Suitable for 1-phase wet cleaning
- Innovative design
- Robust and durable
- Made of high-quality plastic and free of material susceptible to corrosion
- Self-activated wringing through softpoint

Compatible floor cleaning systems

Sprint • Sprint Plus • Clipper • Aquva

Compatible cleaning trolley

Equipe • Shopster • Variant • Varietta • AquvaVIZ • Mistral • Wet mop trolley



 TOOLS
TWIXTER SYSTEM
(40 CM)

FLOOR CLEANING

The superior concept of the Twixter cleaning system can be applied universally. It offers a functional, ecologically and ergonomically convincing and technically reliable solution for all surfaces. Cleverly-designed right down to the last detail, Twixter optimises your work processes. With the double-sided cover, you can complete wet and dry mopping in just one operation. Every second cover change is cut out; furniture has to be moved just one time. This cuts down on transit time and washing costs.

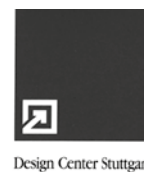

Q AT A GLANCE

- **Surface coverage 30–40 m²**

Double the coverage of conventional flat mopping systems

- **Best cleaning results**

Clean thanks to intelligent 2-phase cleaning with one mop

- **Saves time and costs**

With the double-sided mop, every second mop change is cut out

- **Ergonomic**

All work steps are carried out standing upright

- **Safety for daily cleaning**

Wet and dry mopping in one work step

- **Particularly practical**

Greatest possible manoeuvrability thanks to double joint attached to the side

AREAS OF APPLICATION

- General cleaning
- Disinfectant cleaning
- 1-phase and 2-phase cleaning
- Medium dirt levels

SITE



Hospital / Nursing home • Office / Administration • Large areas (Airport, Exhibition)

METHODS



Twixter-Press • Des tub • Pre-Wash • Dry cleaning • spraymethode • Pour method





 TOOLS
TWIX SYSTEM
(30 CM)

FLOOR CLEANING



For small, heavily-furnished areas in particular, VERMOP has launched the double-sided mop system with a reduced working width of 30 cm. The Twix 30 cm holder features all the advantages of the large version such as no-touch rinsing, wringing and discarding of the mop.

With Twix, floor cleaning is made easy and simple. The compact, practical holder glides over the floor and reaches easily into corners and crevices. Small and heavily-furnished areas such as shops, toilet facilities or kitchenettes can be cleaned quickly and effortlessly. In combination with the wide range of covers for different types of floor, Twix 30 cm guarantees outstanding cleaning results.

Q AT A GLANCE

- **Ideal for small heavily-furnished areas**

Double mop with reduced working width of 30 cm

- **Best cleaning result**

Clean thanks to intelligent 2-phase cleaning with one mop

- **Saves time and costs**

With the double-sided mop, every second mop change is cut out

- **Ergonomic**

All work steps are carried out standing upright

- **Safety for daily cleaning**

Wet and dry mopping in one work step

- **Particularly practical**

Greatest possible manoeuvrability thanks to double joint attached at side

AREAS OF APPLICATION

- General cleaning
- Disinfectant cleaning
- 1-phase and 2-phase cleaning
- Medium dirt levels

SITE













Hotel • Office / Administration • Small areas (Shop, Doctors' surgeries)







METHODS











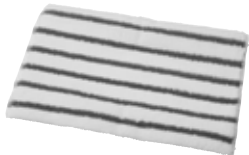



Twix-Press • Des tub • Pre-Wash • Dry cleaning • spraymetode • Pour method







		code	pack. unit
HOLDER			
	Twixter Holder 40 cm	10034	10
TWIXTER MOP			
	Twixter Tronic 40 cm, blue 40 cm, red 40 cm, green 40 cm, yellow	14733 1473382 1473384 1473385	25 25 25 25
	Material: Polyester / Cotton / Microfibre; tufted; Application: Damp cleaning, Wet cleaning; Double sided mop		
	Twixter White Magic 40 cm, white	14738	25
	Material: Polyester / Microfibre; Application: Damp cleaning, Wet cleaning; Double sided mop		
	Twixter Ceran 40 cm, white	14154	25
	Material: Microfibre; Application: Dry cleaning; Double sided mop		
	Twixter Brush 40 cm, red	14768	25
	Material: Brush material / Polyester / PA microfibre with bristle stripes; Application: Wet cleaning; Double sided mop		
	Twixter double Brush 40 cm, red	14764	25
	Material: Polyester / PA microfibre with bristle stripes; Application: Wet cleaning; Double sided mop		

		code	pack. unit
	<p>Twixter Blue 40 cm, blue</p> <hr/> <p>Material: Brush material / Microfibre; Application: Wet cleaning; Double sided mop</p>	14734	25
	<p>Twixter Red 40 cm, red</p> <hr/> <p>Material: Brush material / Microfibre; Application: Wet cleaning; Double sided mop</p>	1473482	25
	<p>Twixter Antibak 40 cm, green</p> <hr/> <p>Material: Cotton / Polyester; tufted; Application: Wet cleaning; Double sided mop</p>	14760	25
	<p>Twixter Classic 40 cm, blue 40 cm, red 40 cm, green 40 cm, yellow</p> <hr/> <p>Material: Polyester / Cotton; tufted; Application: Damp cleaning, Wet cleaning; Double sided mop</p>	14731 1473182 1473184 1473185	25 25 25 25
	<p>Twixter Basic 40 cm, blue 40 cm, red 40 cm, green 40 cm, yellow</p> <hr/> <p>Material: Cotton / Polyester; tufted; Application: Damp cleaning, Wet cleaning; Double sided mop</p>	14721 1472182 1472184 1472185	25 25 25 25
	<p>Twixter Tronic Light 40 cm, anthracite</p> <hr/> <p>Material: Polyester / Cotton / Microfibre; tufted; Application: Damp cleaning, Wet cleaning; Double sided mop</p>	14735	25

		code	pack. unit
	<p>Twixter Progressive 40 cm, white</p> <hr/> <p>Material: Polyester / Microfibre; sewn; Application: Wet cleaning, Damp cleaning; Double sided mop</p>	14724	25
	<p>Twixter Brush Progressive 40 cm, anthracite</p> <hr/> <p>Material: Brush material / Microfibre; sewn; Application: Damp cleaning, Wet cleaning; Double sided mop</p>	14766	25

		code	pack. unit
HOLDER			
	Twix Holder 30 cm	10033	10
TWIX MOP			
	Twix Tronic 30 cm, blue 30 cm, red 30 cm, green 30 cm, yellow	14793 1479382 1479384 1479385	25 25 25 25
	Material: Polyester / Cotton / Microfibre; tufted; Application: Damp cleaning, Wet cleaning; Double sided mop		
	Twix White Magic 30 cm, white	14798	25
	Material: Polyester / Microfibre; Application: Damp cleaning, Wet cleaning; Double sided mop		
	Twix Ceran 30 cm, white	14795	25
	Material: Microfibre; Application: Dry cleaning; Double sided mop		
	Twix double Brush 30 cm, red	14792	25
	Material: Polyester / PA microfibre with bristle stripes; Application: Wet cleaning; Double sided mop		
	Twix Blue 30 cm, blue	14794	25
	Material: Brush material / Microfibre; Application: Wet cleaning; Double sided mop		

FLOOR CLEANING

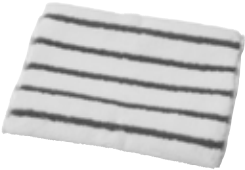
		code	pack. unit
	<p>Twix Red 30 cm, red</p> <hr/> <p>Material: Brush material / Microfibre; Application: Wet cleaning; Double sided mop</p>	1479482	25
	<p>Twix Antibak 30 cm, green</p> <hr/> <p>Material: Cotton / Polyester; tufted; Application: Wet cleaning; Double sided mop</p>	14790	25
	<p>Twix Classic 30 cm, blue 30 cm, red 30 cm, green 30 cm, yellow</p> <hr/> <p>Material: Polyester / Cotton; tufted; Application: Damp cleaning, Wet cleaning; Double sided mop</p>	14791 1479182 1479184 1479185	25 25 25 25
	<p>Twix Basic 30 cm, blue 30 cm, red 30 cm, green 30 cm, yellow</p> <hr/> <p>Material: Cotton / Polyester; tufted; Application: Damp cleaning, Wet cleaning; Double sided mop</p>	14797 1479782 1479784 1479785	25 25 25 25
	<p>Twix Progressive 30 cm, white</p> <hr/> <p>Material: Polyester / Microfibre; sewn; Application: Wet cleaning, Damp cleaning; Double sided mop</p>	14726	25
	<p>Twix Brush Progressive 30 cm, anthracite</p> <hr/> <p>Material: Brush material / Microfibre; Application: Damp cleaning, Wet cleaning; Double sided mop</p>	14799	25



TOOLS

SPRINT SYSTEM

FLOOR CLEANING



The generation Sprint V flat mop holder guarantees dual time saving for daily use. Your cleaning staff can attach mops faster than ever before; thanks to the holder's V shape, it slips smoothly into the pouches of the mop. A further benefit is that new staff do not have to be trained specially! The holder also contributes to greater square meter coverage in premises cleaning as it is particularly light and manoeuvrable and allows a speedy mopping process, even in heavily-furnished areas. Furthermore, with the Sprint V holder, you are also investing into your staff's back health.

The holder is opened via a hand switch while the operator remains in an upright position and the mop is discarded hygienically without having to be touched. Bending down to lift up dirty mops is no longer necessary! Of course you can also have complete confidence in the cleaning performance of the Sprint V. The optimised contact surface of the holder ensures even mopping and very good dirt removal.

Combine the Sprint V with the versatile and durable VERMOP Sprint flat mop and the Scandic X telescopic handle for the right working height.

Q AT A GLANCE

- **Simple attachment**

Easy insertion of the holder into the pouches of the mop thanks to the V shape

- **Ergonomic working**

Hand-switch opening of the holder and mop discarding while standing upright

- **Hygienic**

No touching of soiled mops when discarding

- **Spotless cleaning results**

Optimum contact of the holder for very good dirt removal

- **Fast, labour-saving work**

Extremely manoeuvrable and smooth-running holder

AREAS OF APPLICATION

- General cleaning
- Disinfectant cleaning
- Wet cleaning
- High degree of soiling

SITE



Hospital / Nursing home • School / Nursery • Office / Administration • Industry • Hotel

METHODS



F1 flat wringer • Vertical wringer VK 4 • Des tub • Pre-Wash • Dosing sieve • Dry cleaning • Spray method • Pour method





Q AT A GLANCE

- **High cleaning performance**

Ideal for premises with high levels of dirt

- **Hygienic use**

Particularly hygienic as rinsing and wringing all happens without hand contact



TOOLS

SPRINT PLUS SYSTEM

FLOOR CLEANING

With the Sprint Plus System, you wring out your mop without taking it off the holder. Touch-free and therefore particularly hygienic. In addition to the conventional pockets, the Sprint Plus Mop is also equipped with a loop which is threaded into the matching Sprint Plus holder.

AREAS OF APPLICATION

- General cleaning
- Wet cleaning
- High degree of soiling

SITE







School / Nursery • Office / Administration • Industry







METHODS



















Vertical wringer VK 4 • Spray method • Pour method

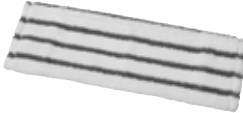









		code	pack. unit
HOLDER			
	Sprint V Holder 40 cm, yellow 50 cm, yellow	10049 10059	10 10
	Accessories Sprint V Clip, Set, yellow	1882705	1
	<hr/>		
	Sprint Plus Holder 40 cm, incl. clip, yellow 40 cm, without clip, blue 40 cm, without clip, red 40 cm, without clip, green	10040 1004001 1004002 1004004	10 10 10 10
	Accessories clips (pair) for cloth cleaning, for holder 0040, yellow	18814	1
	<hr/>		
	Sprint Plus Holder 50 cm, incl. clip, yellow 50 cm, without clip, blue 50 cm, without clip, red 50 cm, without clip, green	10050 1005001 1005002 1005004	10 10 10 10
	Accessories clips (pair) for cloth cleaning, for holder 0050, yellow	18815	1
<hr/>			
	Sprint Holder, stainless steel 40 cm, yellow 50 cm, yellow	10047 10054	10 10
	Suitable for cleanroom use		
	<hr/>		
MOP			
	Sprint Tronic 40 cm, blue 40 cm, red 40 cm, green 40 cm, yellow	14084 1408482 1408484 1408485	50 50 50 50
	Material: Polyester / Cotton / Microfibre; tufted; Application: Damp cleaning, Wet cleaning; Flat mop		
	<hr/>		
	Sprint Tronic 50 cm, blue 50 cm, red 50 cm, green 50 cm, yellow	14095 1409582 1409584 1409585	50 50 50 50
	Material: Polyester / Cotton / Microfibre; tufted; Application: Damp cleaning, Wet cleaning; Flat mop		

FLOOR CLEANING

		code	pack. unit
	Sprint White Magic 40 cm, white 50 cm, white	14474 14470	50 50
	Material: Polyester / Microfibre; sewn; Application: Damp cleaning, Wet cleaning; Flat mop		
	Sprint White Magic OA 40 cm, white 50 cm, white	1447485 1447085	50 50
Material: Polyester / Microfibre; Application: Damp cleaning, Wet cleaning; Flat mop Equipped with: without outer fringes			
	Sprint Ceran 40 cm, white 50 cm, white	14484 14480	50 50
	Material: Microfibre; Application: Dry cleaning; Flat mop		
	Sprint Ceran OA 40 cm, white 50 cm, white	1448485 1448085	50 50
	Material: Microfibre; Application: Dry cleaning; Flat mop Equipped with: without outer fringes		
	Sprint Brush 40 cm, red 50 cm, red	1444885 1444085	50 50
	Material: Polyester / PA microfibre with bristle stripes; Application: Wet cleaning; Flat mop		
	Sprint Blue 40 cm, blue 40 cm, red 50 cm, blue 50 cm, red	14434 1443482 14430 1443082	50 50 50 50
	Material: Brush material; Application: Wet cleaning; Flat mop		

		code	pack. unit
	inside outside		
	Sprint Antibak 40 cm, green loop loop 50 cm, green loop loop	14340 14350	50 50
	Material: Cotton / Polyester; tufted; Application: Wet cleaning; Flat mop Equipped with: loop = looped fringe, cut = open fringe		
	inside outside		
	Sprint Classic 40 cm, white loop cut 50 cm, white loop cut	14584 14501	50 50
	Material: Polyester / Cotton; tufted; Application: Damp cleaning, Wet cleaning; Flat mop Equipped with: loop = looped fringe, cut = open fringe		
	inside outside		
	Sprint Basic 40 cm, white loop cut 50 cm, white loop cut	14824 14821	50 50
	Material: Cotton / Polyester; tufted; Application: Damp cleaning, Wet cleaning; Flat mop Equipped with: loop = looped fringe, cut = open fringe		
	inside outside		
	Sprint Ultra 40 cm, white loop loop 50 cm, white loop loop	14582 14552	50 50
	Material: Polyester / Viscose; tufted; Application: Wet cleaning; Flat mop Equipped with: loop = looped fringe, cut = open fringe		
	inside outside		
	Sprint Tronic Light 40 cm, anthracite loop loop 50 cm, anthracite loop loop	14082 14092	50 50
	Material: Polyester / Cotton / Microfibre; tufted; Application: Damp cleaning, Wet cleaning; Flat mop Equipped with: loop = looped fringe, cut = open fringe		
	inside outside		
	Sprint Progressive 40 cm, blue 40 cm, red 40 cm, white	1442481 1442482 14424	50 50 50
	Material: Polyester / Microfibre; sewn; Application: Wet cleaning, Damp cleaning; Flat mop		

		code	pack. unit	
 	Sprint Progressive 50 cm, blue 50 cm, red 50 cm, white	1442681 1442682 14426	50 50 50	
	Material: Polyester / Microfibre; sewn; Application: Wet cleaning, Damp cleaning; Flat mop			
	 	Sprint Brush Progressive 40 cm, anthracite 50 cm, anthracite	14442 14446	50 50
		Material: Brush material / Microfibre; Application: Damp cleaning, Wet cleaning; Flat mop		
		inside	outside	
 	Sprint Basic Light 40 cm, white 50 cm, white	loop loop loop loop	14884 14885	50 50
	Material: Polyester / Cotton; tufted; Application: Damp cleaning, Wet cleaning; Flat mop Equipped with: loop = looped fringe, cut = open fringe			
		inside	outside	
 	Sprint cleanroom 1 40 cm, white 50 cm, white	loop loop loop loop	14354 14355	50 50
	Material: made of special yarn suitable for cleanrooms; sewn; Application: Wet cleaning; Flat mop Suitable for cleanroom use conditioning: autoclavable Certificate: EU GMP A/B; ISO 7 (DIN EN ISO 14644-1)			
		inside	outside	
 	Sprint White Magic cleanroom 40 cm, white 50 cm, white		1447485PES 1447085PES	50 50
	Material: Polyester / Microfibre; Application: Wet cleaning; Flat mop Suitable for cleanroom use conditioning: autoclavable Certificate: ISO 7 (DIN EN ISO 14644-1); cleaning efficiency according to SPC categories: 99,9%			
		inside	outside	

		code	pack. unit		
HOLDER					
 	Sprint Plus Holder				
	40 cm, incl. clip, yellow	10040	10		
	40 cm, without clip, blue	1004001	10		
	40 cm, without clip, red	1004002	10		
	40 cm, without clip, green	1004004	10		
	Accessories				
	clips (pair) for cloth cleaning, for holder 0040, yellow	18814	1		
Sprint Plus Holder					
 	Sprint Plus Holder				
	50 cm, incl. clip, yellow	10050	10		
	50 cm, without clip, blue	1005001	10		
	50 cm, without clip, red	1005002	10		
	50 cm, without clip, green	1005004	10		
	Accessories				
	clips (pair) for cloth cleaning, for holder 0050, yellow	18815	1		
MOP					
 	Sprint Plus Tronic				
	40 cm, blue	14944	50		
	50 cm, blue	14954	50		
	Material: Polyester / Cotton / Microfibre; tufted; Application: Damp cleaning, Wet cleaning; Flat mop; 1 loop				
		inside	outside		
 	Sprint Plus Classic				
	40 cm, white	loop	cut	14942	50
	50 cm, white	loop	cut	14952	50
	Material: Polyester / Cotton; tufted; Application: Damp cleaning, Wet cleaning; Flat mop; 1 loop Equipped with: loop = looped fringe, cut = open fringe				
		inside	outside		
 	Sprint Plus Basic				
	40 cm, white	loop	cut	14940	50
	50 cm, white	loop	cut	14950	50
	Material: Cotton / Polyester; tufted; Application: Damp cleaning, Wet cleaning; Flat mop; 1 loop Equipped with: loop = looped fringe, cut = open fringe				



Q AT A GLANCE

- **Even surface**

Optimum cleaning results thanks to the closed contact surface and even pressure distribution

- **Hygienic use**

Particularly hygienic, as the strap attachment of the mop means there is no hand contact



TOOLS

CLIPPER SYSTEM

FLOOR CLEANING

Clipper is the robust and technically-reliable floor wiping system for general cleaning in heavily-soiled areas. Easy to use and suitable for diverse areas of application, Clipper makes a convincing impact in daily use. The Clipper mops come with straps which are quickly attached to the holder with the functional clamping brackets. For “no-touch” rinsing and wringing out of the mop directly on the holder.

AREAS OF APPLICATION

- General cleaning
- Wet cleaning
- High degree of soiling

SITE







School / Nursery • Office / Administration • Industry

METHODS



Vertical wringer VK 4 • Spray method • Pour method

		code	pack. unit
HOLDER			
	Clipper Holder, Plastic		
	40 cm	10042	10
	50 cm	10055	10
MOP			
		inside	outside
	Clipper Tronic, tufted		
	40 cm, blue	loop	loop
	50 cm, blue	loop	loop
	Material: Polyester / Cotton / Microfibre; tufted; Application: Damp cleaning, Wet cleaning; Flat mop; 2 loops Equipped with: loop = looped fringe, cut = open fringe		
	Clipper White Magic		
	40 cm, white		14274
	50 cm, white		14275
	Material: Polyester / Microfibre; Application: Wet cleaning, Damp cleaning; Flat mop; 2 loops		
		inside	outside
	Clipper Basic, tufted		
	40 cm, white	loop	cut
	50 cm, white	loop	cut
	Material: Cotton / Polyester; tufted; Application: Damp cleaning, Wet cleaning; Flat mop; 2 loops Equipped with: loop = looped fringe, cut = open fringe		



Q AT A GLANCE

- **Ideal working width**

The right working width for every area size

- **High coverage**

Time-saving cleaning of large areas with 120 cm working width and the Scandic Cleaning Speed Runner

- **Simple principle**

Simple mop attachment and changing thanks to velcro principle

- **Ergonomic work**

Low holder weight for ergonomic working



TOOLS

SCANDIC MONO SYSTEM

FLOOR CLEANING

Scandic Mono is the functional velcro mop concept for wet, damp and dry floor cleaning. With the light holder in various working widths, it is suitable for a number of purposes from small areas (e.g. areas with lot of furniture) to large surfaces (e.g. in gymnasias, production facilities or large reception areas). Similarly, the Scandic Mono is ideal for cleaning ceilings and walls. Combined with high-quality microfibre covers, the Scandic Mono guarantees optimum cleaning results.

AREAS OF APPLICATION

- General cleaning
- Damp cleaning
- Dry cleaning
- Occasional cleaning
- Low dirt levels

SITE



School / Nursery • Office / Administration • Large areas (Airport, Exhibition) • Small areas (Shop, Doctors' surgeries) • Hotel

METHODS



Dry cleaning • Des tub • Pre-Wash • Dosing sieve • Spray method • Pour method

Q AT A GLANCE



- **High coverage**

Double-sided holder with double the coverage

- **Simple principle**

Simple mop attachment and changing thanks to velcro principle

- **Ergonomic work**

Low holder weight for ergonomic working

- **Environment-friendly dry wiping**

The high-tech microfiber technology saves water and chemicals



TOOLS

SCANDIC DUO SYSTEM

FLOOR CLEANING

Ideal for dry cleaning of all smooth floor surfaces such as laminate, parquet, coated or sealed floors. The dust is bound by the electrostatically charged Ceran Mop without agitating the dust.

The outstanding sliding properties and the high-tech microfibres provide an optimum cleaning result, saving water and cleaning agents at the same time.

AREAS OF APPLICATION

- General cleaning
- Damp cleaning
- Dry cleaning
- Occasional cleaning
- Low dirt levels

SITE











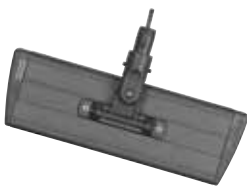

School / Nursery • Office / Administration • Large areas (Airport, Exhibition) • Hotel

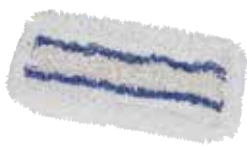
METHODS



Dry cleaning

		code	pack. unit
HOLDER			
	Scandic Mono Holder		
	28 cm	10228	10
	40 cm	10204	10
	60 cm	10206	10
	80 cm	10208	10
	120 cm	10212	5
Scandic Duo Holder			
	40 cm	10240	10
	60 cm	10260	10
Scandic Cleaning Speed Runner			
	Scandic Cleaning Speed Runner	15700	1
	Price on request		
Accessories			
	Scandic Mono Ceran, 120 cm, white	14112	5
plastic covering for Scandic holder			
	plastic covering for Scandic holder	18817	1
velcro strips for Scandic holder 28 cm			
	velcro strips for Scandic holder 28 cm	10232	10
	velcro strips for Scandic holder 40 cm	10234	10
	velcro strips for Scandic holder 60 cm and 120 cm	10236	10
SCANDIC MONO MOP			
Scandic Mono Tronic			
	28 cm, blue	14108	25
	40 cm, blue	14105	25
	60 cm, blue	14106	25
	80 cm, blue	14109	25
	120 cm, blue	14102	5
Material: Polyester / Cotton / Microfibre; tufted; Application: Damp cleaning, Wet cleaning; Velcro mop			

		code	pack. unit
	<p>Scandic Mono White Magic 28 cm, white</p> <hr/> <p>Material: Polyester / Microfibre; Application: Damp cleaning, Wet cleaning; Velcro mop</p>	14129	25
	<p>Scandic Mono White Magic OA 28 cm, white</p> <hr/> <p>Material: Polyester / Microfibre; Application: Damp cleaning, Wet cleaning; Velcro mop</p>	1412985	25
	<p>Scandic Mono Ceran 28 cm, white 40 cm, white 60 cm, white 80 cm, white 120 cm, white</p> <hr/> <p>Material: Microfibre; Application: Dry cleaning; Velcro mop</p>	14128 14124 14126 14118 14112	25 25 25 25 5
	<p>Scandic Mono Blue 28 cm, blue</p> <hr/> <p>Material: Brush material; sewn; Application: Damp cleaning, Wet cleaning; Velcro mop</p>	14130	25
SCANDIC DUO MOP			
	<p>Scandic Duo Ceran 40 cm, white 60 cm, white</p> <hr/> <p>Material: Microfibre; Application: Dry cleaning; Velcro double mop</p>	14174 14176	25 25

FLOOR CLEANING



Q AT A GLANCE

- **Wide coverage**

Wide-wipe system with generous working width, ideal for large areas

- **Thorough cleaning**

Thorough cleaning even in corners and along the edges

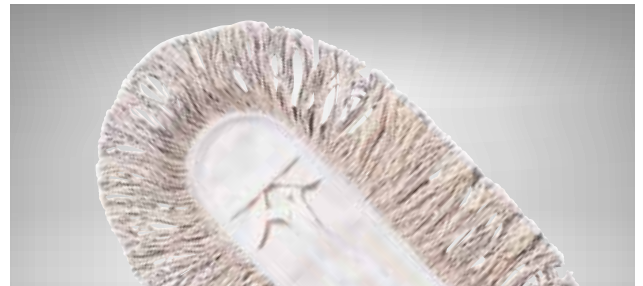

TOOLS

DAMP MOP SYSTEM

FLOOR CLEANING

The damp mop system is the fast and effective method of hygienically picking up dust, damp or dry. Good gliding properties with low weight and the right holder size for small to large areas ensure optimum cleaning results, even in corners and crevices.

AREAS OF APPLICATION

- Damp cleaning
- Dry cleaning
- Low dirt levels

SITE











School / Nursery • Large areas (Airport, Exhibition)

METHODS



Dry cleaning • Spray method

		code	pack. unit		
HOLDER					
	Damp mop Holder, zinc-plated				
	40 cm	10043	10		
	60 cm	10063	10		
	80 cm	10083	5		
<hr/>					
	Damp mop Holder, zinc-plated				
	110 cm	10111	5		
	130 cm	10131	5		
	160 cm	10161	5		
<hr/>					
MOP					
	Damp mop Ceran, with pocket				
	60 cm, white	14120	20		
	80 cm, white	14121	20		
	110 cm, white	14111	5		
	130 cm, white	14113	5		
	160 cm, white	14117	5		
<hr/>					
Material: Microfibre; Application: Dry cleaning					
		inside	outside		
	Damp mop Acryl, with pocket				
	60 cm, yellow	cut	cut	14206	10
	80 cm, yellow	cut	cut	14208	10
	<hr/>				
Material: Synthetic; Application: Dry cleaning Equipped with: loop = looped fringe, cut = open fringe					
		inside	outside		
	Damp mop Acryl, with band				
	40 cm, yellow	cut	cut	14205	10
	110 cm, yellow	cut	cut	14211	5
	130 cm, yellow	cut	cut	14213	5
	160 cm, yellow	cut	cut	14217	5
	<hr/>				
Material: Synthetic; Application: Dry cleaning Equipped with: loop = looped fringe, cut = open fringe					
		inside	outside		
	Damp mop Basic, with pocket				
	40 cm, white	cut	cut	14694	50
	60 cm, white	cut	cut	14696	50
	80 cm, white	cut	cut	14698	20
<hr/>					
Material: Cotton / Polyester; Application: Damp cleaning Equipped with: loop = looped fringe, cut = open fringe					

			code	pack. unit	
		inside	outside		
	Damp mop Basic, with band				
	110 cm, white	cut	cut	14681	5
	130 cm, white	cut	cut	14683	5
	160 cm, white	cut	cut	14686	5
		Material: Cotton / Polyester; Application: Damp cleaning Equipped with: loop = looped fringe, cut = open fringe			
FLOOR CLOTHS					
	Disposable fleece cloth				
	30 x 60 cm			18512	1200
	60 x 60 cm			18513	600
	Disposable fleece cloth				
	20 x 60 cm			18511	1600



FLOOR CLEANING



Q AT A GLANCE

- **High cleaning solution absorption**

Fringed mop with high water absorption properties, ideal for absorbing and distributing large quantities of cleaning solution

- **High dirt absorption**

Ideal absorption of high levels of dirt



TOOLS

AQUVA SYSTEM

FLOOR CLEANING

Aquva is the classic wet wiping system for sanitary areas and open areas with heavy soiling. Practical and convenient, it is suitable for large and small areas and is ideal for distributing or mopping up large quantities of water.

AREAS OF APPLICATION

- Wet cleaning
- High degree of soiling

SITE









Industry

METHODS



Vertical wringer VK 4

		code	pack. unit
HOLDER			
	Aquva holder, plastic	18024	10
	Aquva holder with stainless steel bow	18027	10
MOP			
	Aquva Robbe		
	350 g, with band, white	13334	50
	400 g, with band, white	13354	50
	450 g, with band, white	13364	50
	Material: Cotton / Polyester; Application: Wet cleaning; Dolly mop		
	Aquva Basic		
	350 g, with band, white	13114	50
	400 g, with band, white	13120	50
	450 g, with band, white	13126	50
	Material: Cotton / Polyester; Application: Wet cleaning; Dolly mop		
MINI AQUVA			
	Mini Aquva set without handle	19363	12
	Replacement parts		
	Mini Aquva spare mop	19365	24
	Accessories		
	Mini Aquva handle with thread	18943	25
	Mini Aquva handle with thread	18943	25



TOOLS

SCANDIC X SYSTEM

FLOOR CLEANING

The typical cleaning trolley carries numerous pieces of additional cleaning equipment. No norms apply with regards to their attachment to the handle. Various systems make it necessary to carry a range of handles on the trolley. This gives rise to costs, affects the tidy appearance of the trolley and harbours the danger of damage to the premises. With the Scandic X system from VERMOP, these everyday problems are a thing of the past. The Scandic X telescopic handle can be adjusted simply to various working heights, from 80 cm length for mirror cleaning to 171 cm for overhead work.

With the unique Scandic X connector system, all VERMOP appliances, and accessories from all major manufacturers, can be attached to the handle simply and securely. Compactly retracted, it is stored tidily in the Scandic X toolbox. The toolbox offers flexible attachment for all appliances for floor and surface cleaning, and disappears neatly into the Equipe cleaning trolley. Allow yourself to be convinced by a general solution that sets new standards in manual cleaning.

Q AT A GLANCE

- **One for all**

Compatible with all VERMOP cleaning equipment and with numerous appliances from other major manufacturers

- **X-treme**

Simple adjustment to the right working length at the push of a button - from 80 cm to 171 cm

- **Flexible coupling system**

With one click, the appliances can be attached safely and securely

- **Ergonomics**

Simple adjustment without inconvenient twisting

- **Stable and durable**

High quality material for long service life

AREAS OF APPLICATION

- Floor cleaning
- Surface cleaning
- Wall cleaning
- Ceiling cleaning

COMPATIBLE SYSTEMS

- Floor cleaning systems
- Element mop holder
- Brushes and brooms
- TopLock glass cleaning
- Pad holder
- Squeegee





Q AT A GLANCE

▪ Ergonomic work

Ergonomic design for cleaning that takes the pressure of back and joints

▪ Stable setting

Extremely stable thanks to innovative locking mechanism



TOOLS

SCANDIC TELESCOPIC HANDLE







FLOOR CLEANING





The Scandic telescopic handle is distinguished by its ergonomic design. Combined with any of the VERMOP holder systems, the easily adjustable Scandic telescopic handle is always at the most ergonomic working height. The non-slip ball grip - also available as a rotating version – relieves the wrist during the mopping process. A retaining ring serves as a practical and safe support for the user's hand when working overhead.









AREAS OF APPLICATION





- Floor cleaning
- Ceiling und wall cleaning







We recommend the rotating ball version for the Twixter system, the Sprint V system and the Scandic Duo system, the fixed ball version for the Sprint Plus system and for the Scandic Mono system.

		code	pack. unit
HANDLE			
	<p>Scandic X telescopic handle</p> <hr/> <p>Dimensions: 80 cm - 171 cm Equipped with: Connector system</p>	1890005	5
ADAPTER			
	<p>Scandic X TopLock</p> <hr/> <p>fits all TopLock, LockHead squeegee, Element mop holder, Element mop holder Des, Wall brush, Pipe brush, broom head, V-mop, Radiator cleaner</p>	18917010	10
	<p>Scandic X Scandic</p> <hr/> <p>fits all Scandic Mono, Scandic Duo</p>	18917040	10
	<p>Scandic X handle ø 19,5 mm</p> <hr/> <p>19,5 mm fits all commercially-available holder systems</p>	18917050	10
	<p>Scandic X handle ø 23,5 mm</p> <hr/> <p>23,5 mm fits all Twixter, Twix, all Sprint systems and Clipper</p>	18917020	10
	<p>Scandic X handle ø 23.5 mm long</p> <hr/> <p>e. g. Aquva; 23,5 mm fits all Aquva, Grouting brush, Edge and wall cleaning device, Damp mop, Squeegee</p>	18917030	10







		code	pack. unit
PAD HOLDER			
	<p>Scandic X pad holder</p> <hr/> <p>Dimensions: 250 x 90 mm</p>	18330	1
PAD			
	<p>Textronic Pad</p>	12530	1
ACCESSORIES			
 <ul style="list-style-type: none"> .01 .02 .04 .05 .06 	<p>Scandic X Toolbox "Platinum White"</p> <hr/> <p>pull-out fits all Scandic X System, Equipe Cleaning trolleys</p>	164602..	1
	<p>Name badge</p> <hr/> <p>Dimensions: 80 x 10 mm Self-adhesive, for labelling, transparent fixing film fits all Scandic X telescopic handle</p>	18927	10
INDIVIDUAL			
	<p>Sign, aluminium</p> <p>50 each</p> <p>100 each</p> <hr/> <p>Dimensions: 80 x 10 mm Material: aluminium incl. design and installation fits all Scandic X telescopic handle</p>	<p>1892850</p> <p>18928100</p>	<p>50</p> <p>100</p>









		code	pack. unit
HANDLES			
	<p>Scandic telescopic handle, with rotating ball (Twixter / Twix / Sprint V / Scandic Duo) ø 23,5 mm</p> <hr/> <p>Dimensions: 100 cm - 170 cm</p>	18903	5
	<p>Scandic telescopic handle, with fixed ball (Sprint / Sprint Plus / Scandic Mono) ø 23,5 mm</p> <hr/> <p>Dimensions: 100 cm - 170 cm</p>	18907	5
	<p>telescopic handle, ø 23,5 mm, handle anthracite</p> <hr/> <p>Dimensions: 90 cm - 165 cm</p>	18923	10
	<p>aluminium anodised, 1400 mm, ø 23,5 mm, handle anthracite</p> <hr/> <p>Suitable for cleanroom use</p>	18945	25
	<p>handle, stainless steel</p> <hr/> <p>Material: stainless steel Suitable for cleanroom use</p>	18948	1
ACCESSORIES			
  	<p>Loop-O</p> <hr/> <p>Material: Plastic</p>	18910..	30

		code	pack. unit
	<p>Loop-O</p> <hr/> <p>Material: Plastic colour assortment</p>	1891010	4
TEXTILE PADS			
	<p>pad disc Blue without hole, 17"</p> <hr/> <p>dimensions (ø): 43 cm Material: Brush material; Application: Machine floor cleaning Equipped with: one-sided</p>	18581	1
	<p>pad disc Brush without hole, 17"</p> <hr/> <p>dimensions (ø): 43 cm Material: Polyester / PA microfibre with bristle stripes; Application: Machine floor cleaning Equipped with: one-sided</p>	18582	1
	<p>pad disc White Magic without hole, 17"</p> <hr/> <p>dimensions (ø): 43 cm Material: Polyester / Microfibre; Application: Machine floor cleaning Equipped with: one-sided</p>	18594	1

		code	pack. unit
ACCESSORIES			
	dustpan set complete (anthracite, yellow), in display carton, ready to use	1089005	1
	dustpan set complete (anthracite, blue), in display carton, ready to use	1089001	1
	Replacement parts		
	spare broom for dustpan set	10891	1
	spare stick for dustpan	10893	1
	spare broomstick	10892	1
	dustpan set complete (anthracite, yellow) to be put together on site	1089605	6
	dustpan set complete (anthracite, blue) to be put together on site	1089601	6
	Replacement parts		
	spare broom for dustpan set	10891	1
	spare stick for dustpan	10893	1
	spare broomstick	10892	1
	Dustpan set Des		
	yellow	1089505	6
	Edge and wall cleaning device	18570	10
	Accessories		
	pad, brown	18578	20
	pad, white	18576	20
	pad, red	18573	20
	pad, green	18574	20
	pad		
	red	18573	20
	green	18574	20
	white	18576	20
	brown	18578	20
	Dimensions: 25 x 11 cm		
	pad Brush		
	red	18579	10
	Dimensions: 29 x 13 cm Material: Polyester / PA microfibre with bristle stripes; Application: Wet cleaning		

ACCESSORIES | TOOLS – FLOOR CLEANING

		code	pack. unit
	jointings cleaning brush	12650	5
	Accessories adapter for codes 2650 / 2660	12963	5
	paper picker with handle	12696	10
	Replacement parts paper picker spare tip	12697	5
	Multi-purpose gripper 100 cm	12699	10
	Squeegee 45 cm	18114	10
	55 cm	18115	10
	75 cm	18117	10
	Wringboy bucket incl. wringer	19590	1
	Water filling device	18506	1

		code	pack. unit	
 	Cleaning jacket Satellite XS (32-34) S (36-40) M (42-46) L (48-52) XL (54-56) XXL (58-60)	12200../XS 12200../S 12200../M 12200../L 12200../XL 12200../XXL	1 1 1 1 1 1	
	 	door stopper 97 cm x ø 12 cm (base)	10898	1
		hanging warning sign telescopable 760 mm - 1330 mm	10702	1
		wet floor sign "wet floor" Dimensions: 27.5 x 3.5 x 56.5 cm (W x D x H)	10705	6
		Measuring cup 250 ml 500 ml	18507 18501	1 1
	 	Pressure pump sprayer 1000 ml, yellow 1000 ml, green	1850305 1850304	1 1

	code	pack. unit
 <p>pictogram set with 6 images</p> <p>Dimensions: 8.4 x 8.5 cm</p>	10710	1



FLOOR CLEANING



TOOLS

SURFACE CLEANING

EFFORT-SAVING CLEANING

The extensive VERMOP cloth range offers ideal solutions for all areas of use.

The aim is to ensure simple, labour-saving cleaning with optimised results. In our cloth range, we also emphasise high quality and long service life through careful selection of our raw materials.



BLUE

Application:

General surface cleaning, furniture, office, patient rooms

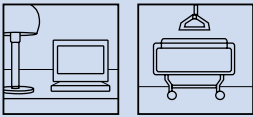

GREEN

Application:

Kitchens



YELLOW

Application:

Isolation wards, operating theatres

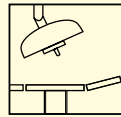

RED

Application:

Toilets, urinals, sanitary surfaces, bath, washbasin, tiles

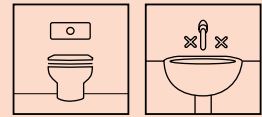

COLOUR CODING FOR GREATER SECURITY

VERMOP offers a suitable selection of colours for cloths and Tuboxxes for the different areas of surface cleaning. The right cloth for every surface, combined with the right cleaning and disinfection fluid. This prevents damage to the surfaces from using the wrong cleaner and guarantees optimum results. Particularly in hygiene-sensitive areas, the colour-coded cleaning system, combined with the disposal of soiled cloths into the laundry bags after each room, can effectively reduce the risk of germs being spread.

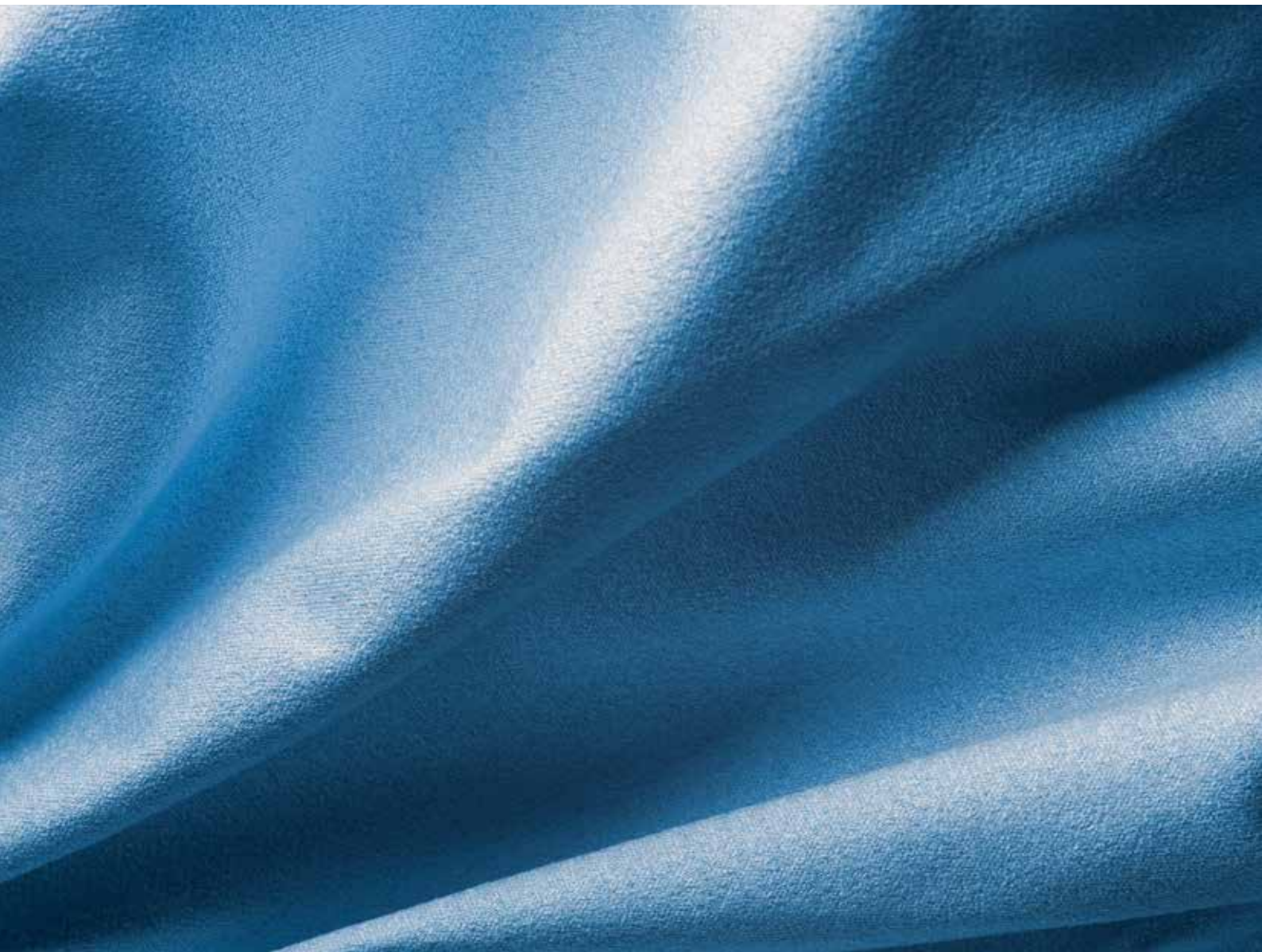

 TOOLS

CLOTH QUALITIES

FOR OPTIMUM RESULTS

With products from the VERMOP cloth range, even the cleaning of demanding and sensitive surfaces is no problem. Selected fibre combinations and manufacturing processes guarantee the best cleaning results on every surface.

TEXTRONIC MICROFIBRE HEAVY-DUTY CLOTH



- Cleaning efficiency tested according to SPC classes by the Fraunhofer IPA Institute
- Very good cleaning performance and gliding properties
- Streak-free sheen for mirrors and chrome

Application

- Ideal for spray cleaning homogenous surfaces
- Suitable for cleanroom use

Material

100 % polyester-microfibre

Care instructions



SOFTTRONIC 1 MICROFIBRE HEAVY-DUTY CLOTH



- Highest cleaning performance
- Due to microfibrils, deep-cleaning even without chemicals
- No separate drying
- Pleasantly pliable

Application

- For dry, damp and wet cleaning of structured surfaces
- Suitable for cleanroom use

Material

75 % polyester-microfibre,
25 % polyamide-microfibre

Care instructions



SOFTTRONIC 2 MICROFIBRE CLEANING CLOTH



Material

75 % polyester-microfibre,
25 % polyamide-microfibre

Care instructions



- Good cleaning performance
- Active cleaning effect due to microfibres
- No separate drying
- Pleasantly pliable

SOFTY MICROFIBRE CLOTH



Material

80 % polyester microfibre,
20 % polyamide microfibre

Care instructions



- Ideal for moist use
- Good cleaning performance and gliding properties
- Active cleaning thanks to microfibres
- Streak-free cleaning without separate drying

PROGRESSIVE MICROFIBRE CLOTH



Material

80 % polyester microfibre,
20 % polyamide microfibre

Care instructions



- Active cleaning thanks to microfibres
- Good rinsing properties
- Economical alternative

ALL-PURPOSE FLEECE CLOTH



Material

Thermo fleece in 85 % viscose,
15 % polypropylene





Care instructions

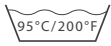

- Effective cleaning, simple drying
- Highly absorbent and very durable

LAUNDRY RECOMMENDATIONS

Wash separately. This prevents the various fibre qualities damaging one another. Do not use a fabric softener!

CLOTH QUALITIES	Maximum laundering temperature	Maximum drying temperature
TEXTTRONIC, SOFTTRONIC 1, SOFTTRONIC 2, SOFTY, PROGRESSIVE		
MULTI-PURPOSE-FLEECE CLOTH		

Key



Do not tumble dry



max 60°C

















max 95°C



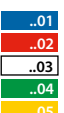



Oxygen bleaching







		code	pack. unit
CLOTHS			
 	<p>Textronic microfibre cloth</p> <hr/> <p>Dimensions: 38 x 40 cm Suitable for cleanroom use conditioning: autoclavable Certificate: EU GMP A/B; ISO 6 (DIN EN ISO 14644-1); cleaning efficiency according to SPC categories: 100% Printing possible with minimum order quantity of 500</p>	18530..	100
 	<p>Softtronic 1 microfibre cloth</p> <hr/> <p>Dimensions: 32 x 32 cm Weight: 330 g/m² Material: 75% polyester-microfibre, 25% polyamide-microfibre Suitable for cleanroom use Certificate: EU GMP A/B; ISO 5 (DIN EN ISO 14644-1)</p>	18525..	20 x 5
 	<p>Softtronic 2 microfibre cloth</p> <hr/> <p>Dimensions: 40 x 40 cm Weight: 250 g/m² Material: 75% polyester-microfibre, 25% polyamide-microfibre</p>	18545..	100
 	<p>Softy cloth</p> <hr/> <p>Dimensions: 40 x 40 cm Weight: 220 g/m² Material: 80% polyester-microfibre, 20% polyamide-microfibre</p>	18536..	100
 	<p>Progressive cloth</p> <hr/> <p>Dimensions: 35 x 40 cm Weight: 270 g/m² Material: 80% polyester-microfibre, 20% polyamide-microfibre</p>	18533..	100
 	<p>multi-purpose-fleece cloth</p> <hr/> <p>Dimensions: 38 x 40 cm Material: Thermo fleece in 85% viscose, 15% polypropylene</p>	18520..	100



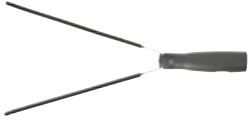



		code	pack. unit
GLOVE MOP			
	<p>Glove mop Ceran</p> <hr/> <p>Dimensions: 14 x 23,5 cm Material: Microfibre Equipped with: yellow binding yellow binding</p>	13962	10
	<p>Glove mop Brush</p> <hr/> <p>Dimensions: 14 x 22 cm Material: Polyester / PA microfibre with bristle stripes</p>	13968	10
	<p>Glove mop White Magic / Blue</p> <hr/> <p>Dimensions: 14 x 23,5 cm Material: Brush material / Microfibre</p>	13975	10







SURFACE CLEANING

		code	pack. unit
ACCESSORIES			
	<p>Hand pad brush</p> <hr/> <p>Dimensions: 165 x 100 mm Polyester / PA microfibre with bristle stripes</p>	1857916	100
	<p>Set element mop with handle, microfibre</p> <hr/> <p>Dimensions: 51 cm</p> <p>Set includes:</p> <p>handle for element mop 1x</p> <p>element mop cover, microfibre 1x</p> <hr/> <p>Accessories</p> <p>element mop cover, cotton</p> <p>element mop cover, White Magic</p>	18394	10
	<p>Set element mop with handle, cotton</p> <hr/> <p>Dimensions: 42 cm</p> <p>Set includes:</p> <p>handle for element mop 1x</p> <p>element mop cover, cotton 1x</p> <hr/> <p>Accessories</p> <p>element mop cover, microfibre</p> <p>element mop cover, White Magic</p>	18396	10
	<p>Set element mop with rubber holder, microfibre</p> <hr/> <p>Dimensions: 39 cm</p> <p>Set includes:</p> <p>element mop holder, rubber 1x</p> <p>element mop cover, microfibre 1x</p> <hr/> <p>Accessories</p> <p>element mop cover, cotton</p> <p>element mop cover, White Magic</p>	18322	10
	<p>Set element mop with rubber holder, White Magic</p> <hr/> <p>Dimensions: 38 cm</p> <p>Set includes:</p> <p>element mop holder, rubber 1x</p> <p>element mop cover, White Magic 1x</p> <hr/> <p>Accessories</p> <p>element mop cover, microfibre</p> <p>element mop cover, cotton</p>	18323	10

		code	pack. unit
	handle for element mop Dimensions: 51 cm	19028	10
	Accessories element mop cover, microfibre	18392	10
	element mop cover, cotton	18391	10
	element mop cover, White Magic	18390	10
	element mop holder, rubber Dimensions: 38 cm	18321	10
	Accessories element mop cover, microfibre	18392	10
	element mop cover, cotton	18391	10
	element mop cover, White Magic	18390	10
	element mop cover, White Magic Dimensions: 27 cm	18390	10
	element mop cover, cotton Dimensions: 26 cm	18391	10
	element mop cover, microfibre Dimensions: 27 cm	18392	10
	element mop holder Dimensions: 58 cm	18320	10
	Accessories element mop cover, Ceran material	18395	10
	element mop cover, White Magic material	18379	10

ACCESSORIES | TOOLS – SURFACE CLEANING

		code	pack. unit
	<p>element mop cover, Ceran material</p> <hr/> <p>Dimensions: 42 cm</p>	18395	10
	<p>element mop cover, White Magic material</p> <hr/> <p>Dimensions: 42 cm</p>	18379	10
	<p>V-mop, with handle</p> <hr/> <p>Dimensions: 50 cm</p>	13980	10
	<p>V-mop, slot in, with handgrip</p> <hr/> <p>Dimensions: 39 cm</p>	13983	10
	<p>V-mop, slot in, extra long, with handgrip</p> <hr/> <p>Dimensions: 67 cm</p>	13984	10
	<p>wall and ceiling brush head, length adjustable 850 - 1500 mm, oval shaped head</p>	19502	6

		code	pack. unit
	wall and ceiling brush head, length adjustable 830 - 1490 mm, round shaped head	19510	12
	Accessories Telescopic handle Z, 300 cm	19411	12
	wall cleaning brush, adaptable to telescopic handle	12662	5
	fits all TopLock telescopic sticks (ø 20 mm) Accessories Telescopic handle Z, 300 cm	12915	10
	pipe cleaning brush, adaptable to telescopic handle	12663	5
	fits all TopLock telescopic sticks (ø 20 mm)		
	compatible broom head	19519	10
	radiator cleaner, incl. cover "Brush" (set consists of 1 tool plus 5 covers)	18300	1
	Set includes: radiator cleaner	1x 18308	10
	cover „Brush“ for radiator cleaner	5x 18310	20
	toilet cleaning set (anthracite / yellow)	1088505	1
	toilet cleaning set (anthracite / red)	1088502	1

SURFACE CLEANING



		code	pack. unit
	Trigger bottle		
	250 ml, blue	1850201	5
	250 ml, red	1850202	5
	Accessories		
	labels ready-to-use solution, floor, green	10820W	15
labels ready-to-use solution, surface, blue	108200	15	
labels ready-to-use solution, sanitary, red	10820S	15	



SURFACE CLEANING



TOOLS

VALUE ADDED PERSPECTIVE

TOPLOCK GLASS CLEANING

The TopLock glass-cleaning system represents the optimum combination cost-effectiveness, quality, ergonomics and functionality. It impresses with innovative technology, perfect workmanship and high-quality material – e.g. profiled aluminium, fibreglass-reinforced plastic and stainless steel.

Closely collaborating with our customers, we constantly work on the advancement and new development of our solutions. Convince yourself of the superior productivity, flexibility and safety features for cleaning glass and smooth surfaces.

T-BAR



With its ergonomic handle, the T-bar is gentle on the thenar. Even with wet hands, unproblematic and secure application is guaranteed.

SQUEEGEE LOCKHEAD



The high quality stainless-steel and non-slip plastic LockHead squeegee, is comfortable to hold. The rails can be changed easily.

GLASSMAN



The Glassman safety scraper with 10cm blade made from Solingen steel is ideally suited for removal of stickers, paint residue and scaling from smooth surfaces.

TELESCOPIC HANDLES



The TopLock telescopic sticks are suitable for all applications, thanks to astonishing flexibility and safety.



 TOOLS

T-BAR

GLASS CLEANING

The TopLock T-bar is perfectly tailored to the LockStrip sleeves. The sleeve fits the T-bar tightly without twisting. The LockStrip sleeve moistens the glass pane evenly and generates a good level of foam. With the T-bar's ergonomic grip, long periods of fatigue-free work are guaranteed. It is optimised to work with the TopLock telescopic sticks and also fits all conventional stick systems.

Q AT A GLANCE

- **Perfect fit**

Long-lasting perfect fit of the LockStrip T-Bar cover

- **Low weight**

For a high level of effectiveness

- **Ergonomic handling**

Protects the thenar with ergonomic handle

- **Secure hold**

Even with wet grip

- **Compatible**

With TopLock and Scandic X telescopic handle

AREAS OF APPLICATION

- Glass panes
- Windows
- Smooth surfaces

SITE



Hospital / Nursing home • School / Nursery • Office / Administration • Industry • Large areas (Airport, Exhibition) • Hotel



Q AT A GLANCE

- **Quick change**

Quick and simple changing of rubber and squeegee with unlock button

- **Ergonomic handling**

Safe working with ergonomic dual component handle



TOOLS







SQUEEGEE LOCKHEAD

GLASS CLEANING







The length of the LockHead squeegee handle is ideally tailored to the interplay of hand anatomy and work movement. For easy, precise and fatigue-free work. Even with wet hands, use is effortless and safe due to the non-slip rubberised handle.



AREAS OF APPLICATION

- Glass panes
- Windows
- Smooth surfaces

		code	pack. unit
T-BAR / SQUEEGEE			
	LockHead handle	12600	10
	handle	12603	10
	LockHead squeegee 25 cm 35 cm 45 cm	12622 12623 12624	10 10 10
	Squeegee 25 cm 35 cm 45 cm	12612 12613 12614	10 10 10
	Replacement rail 25 cm 35 cm 45 cm Equipped with: with rubber	12722 12723 12724	10 10 10
	Squeegee Rubber 25 cm 35 cm 45 cm 92 cm 105 cm	12822 12823 12824 12828 12829	10 10 10 10 10

GLASS CLEANING

		code	pack. unit
	Squeegee Rubber hard		
	25 cm	12822H	10
	35 cm	12823H	10
	45 cm	12824H	10
	92 cm	12828H	10
	105 cm	12829H	10
	To be used in the warm months in the year in particular.		
	T-Bar		
	25 cm	1017206	10
	35 cm	1017306	10
	45 cm	1017406	10
COVER			
	LockStrip Ultra		
	35 cm	1232135	10
	45 cm	1232145	10
	Equipped with: velcro inside; pad		
	LockStrip D		
	25 cm	1236250	10
	35 cm	1236350	10
	45 cm	1236450	10
	Equipped with: snap fastener		
	LockStrip K		
	25 cm	1236270	10
	35 cm	1236370	10
	45 cm	1236470	10
	Equipped with: velcro inside		
	LockStrip pad K		
	25 cm	1237270	10
	35 cm	1237370	10
	45 cm	1237470	10
	Equipped with: velcro inside; pad		

		code	pack. unit
ADAPTER			
	<p>joint, anthracite</p> <hr/> <p>fits all TopLock telescopic sticks (ø 20 mm)</p>	12901	10
	<p>profi-cone with safety button "Pinocchio"</p> <hr/> <p>fits all TopLock telescopic sticks (ø 20 mm)</p>	1290006	10
	<p>adapter to change diameter from telescopic (ø 20 mm) to mop handle (ø 23 mm)</p>	12906	5

Q AT A GLANCE



▪ **Safe application**

Safe attachment of accessories with the changeable Profi cone featuring the Pinocchio safety button

▪ **Easily adjustable**

Easily adjustable with 270° turnable joint

▪ **Ergonomically-formed handle**

Maximum grip due to ergonomically-formed handle





TOOLS

TOPLOCK TELESCOPIC HANDLES

GLASS CLEANING

The TopLock telescopic sticks are suitable for every type of application, due to their astonishingly low weight, safety in operation and the numerous different adapters. Their unique locking-system impresses with its simple handling and absolute precision and is also suitable for left-handed users. Even when fully extended, the TopLock telescopic stick is smooth-running and allows precise guiding without wobbling.

The stick can resist even extreme drag and pressure. It is easy to extend and retract and prevents collapsing upon release. Integrated stoppers prevent fingers from getting caught.

		code	pack. unit
TELESCOPIC HANDLES			
	Telescopic handle Z		
	120 cm	12910	10
	250 cm	12912	10
	300 cm	12915	10
	400 cm	12916	10
	600 cm	12918	10
	Equipped with: two parts		
<hr/>			
	Telescopic handle ZR		
	120 cm	12920	10
	250 cm	12922	10
	300 cm	12925	10
	Equipped with: two parts; with slot		
<hr/>			
	Telescopic handle D		
	180 cm	12930	10
	300 cm	12931	10
	450 cm	12935	10
	600 cm	12936	10
	900 cm	12938	10
	Equipped with: three parts		

Q AT A GLANCE

- **Optimum energy transmission**

Optimum energy transmission with protective cap applied as a grip and blade made of Solingen steel

- **Safe blade**

Safe blade change thanks to the BCS (Blade Change Security System)

- **Safe transport**

Safe transport with locked guard cap



TOOLS







GLASSMAN SAFETY SCRAPER







GLASS CLEANING



Glassman safety scraper with 10 cm Solingen steel blade. Ideal for removing stickers, paint residue and scale from smooth surfaces, particularly glass or ceramic hobs. Attached to the scraper as a handle, the end cap facilitates ergonomic working with optimum transmission of energy. Danger-free blade change thanks to the Blade Change Security System and safe transport with the locked guard cap.



reddot design award
winner

		code	pack. unit
SCRAPER			
	Glassman safety scraper	12743	10
	Replacement parts		
	blades for blade holder, 25 pcs. in a case	12766	10 x 25
	blades for blade holder, 250 pcs. loose in a carton	12765	1
	blades for blade holder, 25 pcs. in a dispenser	12767	10
<hr/>			
	scraper short (for telescopic stick)	12770	10
	Replacement parts		
	replacement blades for window and floor scraper, 10 cm, 10 units in case	12792	10
<hr/>			
	scraper		
	25 cm	12780	10
	120 cm	12790	10
	Equipped with: with handle		
	Replacement parts		
replacement blades for window and floor scraper, 10 cm, 10 units in case	12792	10	
<hr/>			
	blade holder 10 cm + 10 blades in a case	12764	10
	Replacement parts		
	blades for blade holder, 25 pcs. in a case	12766	10 x 25
	blades for blade holder, 250 pcs. loose in a carton	12765	1
	blades for blade holder, 25 pcs. in a dispenser	12767	10
<hr/>			
	safety scraper with blade	12761	20
	Replacement parts		
	replacement blades for code 2761, 4 cm (100 pcs)	12762	1
<hr/>			
ACCESSORIES			
	Profi-bucket yellow 22 l	1268005	10
	Dimensions: 56 x 30 x 33 cm (W x D x H) incl. clip		
	Accessories		
	strainer for Profi-bucket	12681	1
wheels for Profi-bucket, 4 pcs.	12684	1	

		code	pack. unit
	strainer for Profi-bucket	12681	1
	wheels for Profi-bucket, 4 pcs.	12684	1
	quiver	12690	5
	Accessories belt for quiver	12691	5
	apron made of heavy-weight cotton fabric	12695	5
TEXTILES / CHAMOIS LEATHER			
	profi-chamois leather 80 x 60 cm	18580	1
	TopLock microfibre cloth anthracite	1853706	5
	Dimensions: 80 x 60 cm Material: 80% polyester-microfibre, 20% polyamide-microfibre		

		code	pack. unit
SETS			
	Starter Set TopLock 35 cm	12930L	1
	Set includes:		
	Squeegee, 35 cm	1x	12623
	Squeegee Rubber, 35 cm	2x	12823
	T-Bar, 35 cm	1x	1017306
	LockStrip D, 35 cm	1x	1236350
	LockStrip pad D, 35 cm	1x	1237350
	Telescopic handle D, 180 cm	1x	12930
Glassman safety scraper	1x	12743	
<hr/>			
	Starter Set TopLock 45 cm	12940L	1
	Set includes:		
	Squeegee, 45 cm	1x	12624
	Squeegee Rubber, 45 cm	2x	12824
	T-Bar, 45 cm	1x	1017406
	LockStrip D, 45 cm	1x	1236450
	LockStrip pad D, 45 cm	1x	1237450
	Telescopic handle D, 180 cm	1x	12930
Glassman safety scraper	1x	12743	





VERMOP POWER

Performance is the result of invested time and energy. The solutions offered by the VERMOP Power range help you to make this synergy as efficient as never before.

The latest generation of Jetvac vacuum cleaners convinces through their unique combination of compact construction, superior design and low weight. The cordless Jetvac Accu in particular ensures maximum range of movement and effective use of working time without changing sockets.

Be inspired by superior performance in the name of maximum efficiency!

POWER | JETVAC



 POWER
JETVAC

THE POWER OF INNOVATION

Our vacuum cleaners set standards for innovation and quality. Only proven, high performance, long-life components are used.

All Power products have been developed in collaboration with our customers and together with you continuously improved.

JETVAC WITH CABLE

- low sound level
- integrated traction relief
- HEPA filter
- easy to transport, fits in the Equipe cleaning trolley
- powerful motor
- fulfils the current EU eco-design guideline



JETVAC ACCU

- a rechargeable battery without memory effect
- can be used flexibly without a socket
- low sound level
- high output figures with low weight
- simple battery change for a long range





 POWER

JETVAC WITH CABLE

VACUUM CLEANER

The Jetvac universal vacuum cleaner sets new standards when it comes to innovation and quality. It scores with compact construction and superior design. Weighing just 7.2 kg, it is a lightweight in its class. Three smooth-running castors make this powerhouse mobile and its low centre of gravity ensures it moves along without tipping over. The storage compartment offers room for accessories; the extra-long cable is stored in the practical cable rewind. In addition to this, the Jetvac offers two suction settings.

Q AT A GLANCE

- **Low noise level**

Ideal for daytime cleaning due to low noise level

- **Traction relief**

Prevents the cable being ripped off when pulled too hard

- **HEPA filter**

Ideal for allergy sufferers and for hospital cleaning

- **Transport friendly**

Easy to transport due to compact construction with low weight

- **Powerful motor**

Permanently high suction thanks to the powerful motor

AREAS OF APPLICATION

- General cleaning of textile floor covering
- Dry pre-cleaning of hard floors

SITE



Office / Administration • Hospital / Nursing home • School / Nursery





Q AT A GLANCE

- **Without memory effect**

Batteries with modern lithium-ion technology

- **Suitable for flexible use**

Even where no power point is available

- **Low noise level**

Ideal for daytime cleaning due to low noise level of 58 dB

- **Powerful motor**

Permanently high suction thanks to the powerful motor



POWER

JETVAC ACCU

VACUUM CLEANER

Be it for train, bus or aircraft cleaning – the Jetvac accu permits mobile cleaning and provides previously unseen freedom of movement when vacuuming. It is the solution in all those places where no power point is available. And in those areas where a cable can be a real stumbling block, the Jetvac accu is ideally suited for daytime cleaning.







AREAS OF APPLICATION







- Bus / train
- Aeroplane
- General cleaning of textile floor covering
- Dry pre-cleaning of hard floors







SITE







Train • Office / Administration • Hospital / Nursing home • School / Nursery

		code	pack. unit	
MODELS				
 	Jetvac accu	17500..	1	
	Dimensions: 43 x 31 x 40,5 cm (W x D x H) Please order battery pack and charger separately.			
	Set includes:			
	all purpose floor nozzle (26 cm)	1x	17437	1
	round brush nozzle	1x	17415	1
	crevice nozzle	1x	17416	1
	telescopic tube in stainless steel, incl. clip	1x	17417	1
	main filter	1x	17411	1
	dust bag (3,5 l)	10x	17410	10
	hose for Jetvac accu	1x	17419L	1
Replacement parts				
main filter		17411	1	
Accessories				
Battery, 45 min		17510	1	
Battery, 90 min		17519	1	
Charger, 90 min		1752190	1	
Charger, 45 min		17521	1	
HEPA-filter		17412	1	
dust bag (3,5 l)		17410	10	
Jetvac				
 		17450..	1	
	Dimensions: 43 x 31 x 40,5 cm (W x D x H)			
	Set includes:			
	all purpose floor nozzle (26 cm)	1x	17437	1
	round brush nozzle	1x	17415	1
	crevice nozzle	1x	17416	1
	telescopic tube in stainless steel, incl. clip	1x	17417	1
	hose for Jetvac	1x	17419	1
	main filter	1x	17411	1
	dust bag, Fleece, 3,5 l	6x	17441	6
electric cable black, 15 m	1x	17418	1	
Replacement parts				
main filter		17411	1	
electric cable black, 15 m		17418	1	
Accessories				
HEPA-filter		17412	1	
dust bag, Fleece, 3,5 l		17441	6	
dust bag (3,5 l)		17410	10	
NOZZLES				
 	all purpose floor nozzle (26 cm)	17437	1	

		code	pack. unit
	<p>turbo nozzle 28 cm</p> <hr/> <p>Dimensions: 28 cm</p>	17438	1
	<p>extra wide switch-over nozzle (30 cm)</p>	17425	1
	<p>hard surface nozzle (36 cm)</p>	17428	1
	<p>Furniture nozzle (25 cm)</p>	17430	1
	<p>round brush nozzle</p>	17415	1
	<p>crevice nozzle</p>	17416	1

		code	pack. unit
BATTERY			
	Battery		
	45 min	17510	1
	90 min	17519	1
		*Price on request Equipped with: 24 volts	
Charger			
	Charger		
	45 min	17521	1
	90 min	1752190	1
		*Price on request Equipped with: 24 volts	
FILTER			
	main filter	17411	1
	HEPA-filter	17412	1
ACCESSORIES			
	telescopic tube in stainless steel, incl. clip	17417	1
	clip holder for tube	17421	1

POWER

		code	pack. unit
	hose for Jetvac	17419	1
	Replacement parts repair kit for hose - Jetvac / Jetvac accu	17408	1
	hose for Jetvac accu	17419L	1
	Replacement parts repair kit for hose - Jetvac / Jetvac accu	17408	1
	dust bag (3,5 l)	17410	10
	dust bag, Fleece, 3,5 l	17441	6







VERMOP CONSULTING

ALWAYS A DECISIVE STEP AHEAD

Highest cleaning quality in the light of rising cost pressures: As a competent system provider with decades of experience, we support you throughout the entire process chain so you are always a step ahead of the competition.

We help you to maintain set quality and hygiene requirements, fulfill the respective standards and establish reliable quality assurance processes, at the point of linking service provider and client.

The key factor is always the perfect combination of quality and profitability: Together with you we ensure that you can maximise optimisation and cost reduction potentials in each step of your process.

REDUCE COMPLEXITY – MAXIMISE PROFITABILITY

This is how, we support you along the entire added-value chain:

- recording, documentation and analysis of existing processes
- identification of savings potentials and efficiency gains
- alignment of processes to your strategic corporate objectives
- on this basis: design and implementation of optimised or new processes (incl. employee qualification)

Benefit from our know-how of existing process optimisation, for securing new premises and in the event of necessary restructuring!



CONSULTING

WE GUARANTEE

HIGH LEVEL OF KNOWLEDGE TRANSFER

Thanks to many years of professional experience, familiarity with practice and the constant advanced technical, methodical and communicative qualification of our trainers, we can guarantee a high level of knowledge transfer.

TRANSPARENCY

We constantly monitor our performance by means of participant questionnaires. The feedback round is an established element in every seminar. The data collected is transparent and made available to the client.

QUALITY FROM A TO Z

We look beyond the individual seminar and consider the event as a whole. Therefore every seminar booked includes professional work material, a certificate and internal documentation for the participant.

THE FOCUS IS ON EACH INDIVIDUAL PARTICIPANT

Optimum individual support and the personal success of each participant have the highest priority.

PRACTICAL RELEVANCE AND UP-TO-DATENESS

Because knowledge only makes lasting sense when it is conveyed in such a way that participants can actually apply it.

DISCRETION AND CONFIDENTIALITY

We treat all activities with absolute confidentiality.

THE JOY OF LEARNING

"When something is fun, we take it seriously."
(Gerhard Uhlenbruck)



CONSULTING

OUR LOCATION

Our company's own training and education centre in Wertheim is a modern centre for communication and meeting place. Participants appreciate the pleasant venue and use it for a mutual exchange of experience.

- Bright, light-flooded rooms
- A range of seminar rooms in various sizes, permitting variable arrangements
- Numerous practice areas, such as different floor coverings, glass cleaning, hospital room, etc, for the implementation of theoretical knowledge
- Latest technology (beamer, flipchart, pin boards)
- WiFi allowing free internet use during breaks
- All product systems from the VERMOP range available for viewing, use and testing
- Service: During the seminar, snacks in the communication breaks, lunch and a wide range of hot and cold beverages are included in the price. In the summer months, lunch will be provided in the company's own beer garden located next door.



COMPANY OWN TRAINING CENTRE IN
WERTHEIM
(WERK III, CARL-JAKOB-KOLB-WEG 2)



CONSULTING

INDIVIDUAL CONSULTATION

THE AIM

The aim of a professional consultant is to manage the consultation process to allow the client to recognise new possibilities or pathways and learn how to implement those. In all activities for the client the consultant must be absolutely transparent and comprehensible. The basis for successful consultation depends on client requirements and jointly-defined targets. During each phase, the client needs to have the opportunity to influence future activities flexibly.

THE DUAL CONSULTATION

We see successful consultation as a combination of specialist consulting (conveyance of technical know-how and technical solutions in the premises cleaning, hospital and nursing home hygiene and in the food processing areas) and process consultation (optimisation of internal structures, support for staff reviews, employee motivation, elaboration of personal and organisational optimisation processes, etc.).

THE APPROACH

We would be pleased to compile an individual training and consultation concept for you, tailored to your requirements. An individual meeting to determine the actual requirements is a key factor. If these cannot be exactly specified we would be pleased to call on you and actively support you with identifying them (basic check).



CONSULTING

INDIVIDUAL SEMINARS AND CONSULTANCY

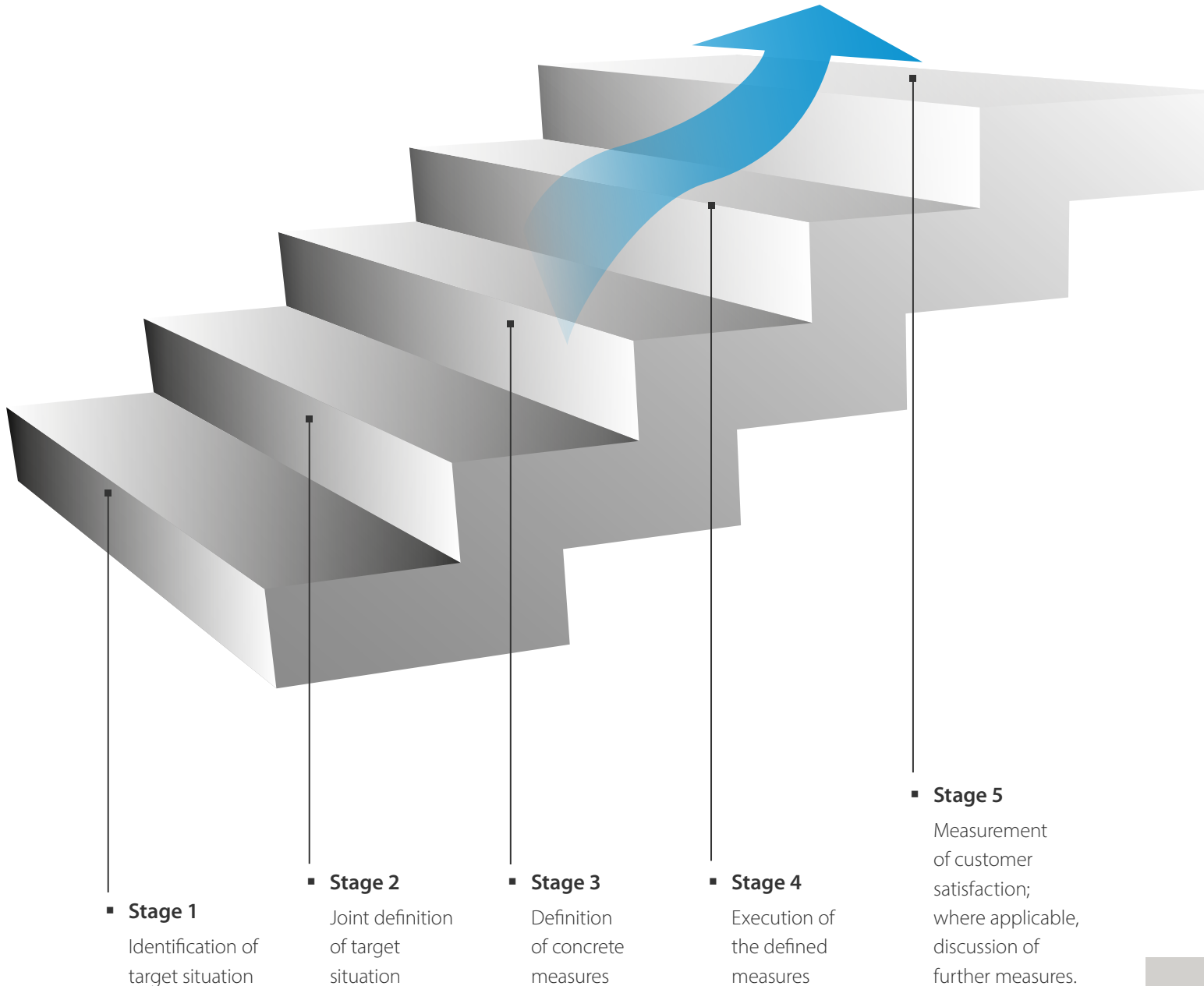

WE WOULD BE PLEASED TO PUT TOGETHER INDIVIDUAL SEMINARS OR TRAINING COURSES FOR YOU: WITH OUR PROFESSIONAL EXPERTISE, TAILORED TO YOUR REQUIREMENTS AND ON SITE.



YOU CAN OBTAIN FURTHER INFORMATION FROM OUR TEAM:
+ 49 9342 878 - 800

MONDAY TO THURSDAY: 8.00 AM – 6.00 PM FRIDAY: 8.00 AM – 3.00 PM



VERMOP®
PROFESSIONAL CLEANING SYSTEMS



FENSTERREINIGER

Reinigung aller
Fensterarten aus Glas
und Acrylglas sowie
wasserbeständigen Rahmen

OBERFLÄCHE

500 ml e



VERMOP LIQUID

EVERYTHING UNDER ONE ROOF – EVERYTHING FROM A SINGLE CAST

For more than 90 years, VERMOP has been a leading expert for cleaning systems and textiles. Now, we have used this combined know-how to develop an innovative range of professional cleaning chemicals.

Both our customers' wishes and also our profound cleaning knowledge are directly included in the development. That means, each of our products is perfectly matched to your cleaning requirements – and to the fibre qualities of our cleaning textiles.

PRECISELY YOUR CHOICE

You not only have a choice between cleaning agents for various areas of application: alongside our standard products, we also offer you natural cleaning agents, which achieve impressive cleaning results although without fossil raw material ingredients.

A particular highlight: On request, we develop your own customised products, tailored to your requirements.

Secure your leadership right down the line – and increase quality and cost-efficiency, also when it comes to your cleaning chemicals!

Q AT A GLANCE



- **Simple and logical dosing**

Innovative dosing insert for the VERMOP 1 litre-bottle; tip once and 10 ml are dispensed; for medium-range or heavier soiling, simply tip twice or three times!

- **Effective formulae**

Powerful, fast and environmentally safe with a high level of material compatibility

- **Safe application**

Due to its triangular form, the VERMOP bottle is easy to hold, securely and safely even with wet gloves

- **Waste reduction**

Ca. 80 % reduction of the volume of waste thanks to foldable refill bag

- **Clear identification**

Simple and easy-to-understand illustration of areas of application, use and dosing thanks to clear pictograms

- **QR code to increase safety at work**

Simply scan QR code and download the EU Safety Data Sheet

LIQUID STANDARD THE POWERFUL CLEANERS

VERMOP Liquid Standard comprises of a range of cleaning agents. They have all been developed in accordance with the latest state of the art in cleaning technology and take current ecological aspects into account



Q AT A GLANCE

- **Products consist of almost 100 % natural sustainable raw materials**
- **Distinguished with the EU Ecolabel**
- **Non-labelled product line for general cleaning**
- **Very good cleaning performance yet very gentle on material**

LIQUID STANDARD THE NATURAL CLEANERS

VERMOP Natur is our range of cleaning agents developed on the basis of sustainable raw materials. It combines sustainability, efficacy and biodegradability and thus supports you in implementing your company's ecological concept. Our VERMOP Natur products are part of a closed cycle beginning and ending with an intact environment. Using almost 100 % sustainable raw materials, we have developed highly-effective cleaning agents which we produce in Germany. We provide you with advice on the environmentally-sound use of our products in daily cleaning. The ultimate step is the absolute biodegradability of the products, thus completing the cycle.



NATUR SANITARY CLEANER

- With citric acid which is among the most widely-used vegetable acids
- Vegetable raw materials are mixed with active microorganisms and citric acid formed through chemical precipitation

For the removal of mineral stains such as lime scaling



NATUR SURFACE CLEANER

- With tensides extracted from coconuts
- Coconut oils are pressed from coconuts and further processed to tensides

For the removal of different forms of stains



NATUR UNIVERSAL CLEANER

- With alcohol produced from wheat
- Grains of wheat are ground and, with the application of heat, enzymatically metabolized and fermented

For the removal of fatty stains





LIQUID INDIVIDUAL

THE INDIVIDUAL CLEANER

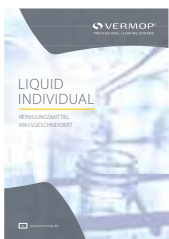

PLEASE REQUEST OUR PRODUCT BROCHURE "LIQUID INDIVIDUAL, TAILORED CLEANING AGENTS" FOR THE COUNTRIES GERMANY, POLAND OR HUNGARY

DEVELOP YOUR OWN PRODUCT!

From a minimum order of 400 l of a product, we offer you the chance to become actively involved in developing your own individual cleaning agent. Drawing on our experience combined with your requirements, we jointly develop a product which represents your company and is specially tailored to your standards, your staff, your premises and your requirements.

DISCOVER THE DIVERSE POSSIBILITIES OF LIQUID INDIVIDUAL

In order to record your individual product-specific wishes in the area of VERMOP Liquid Individual faster and more efficiently, your sales representative is at your disposal. Arrange a meeting to design your own product. We also support you with the documentation of your product.

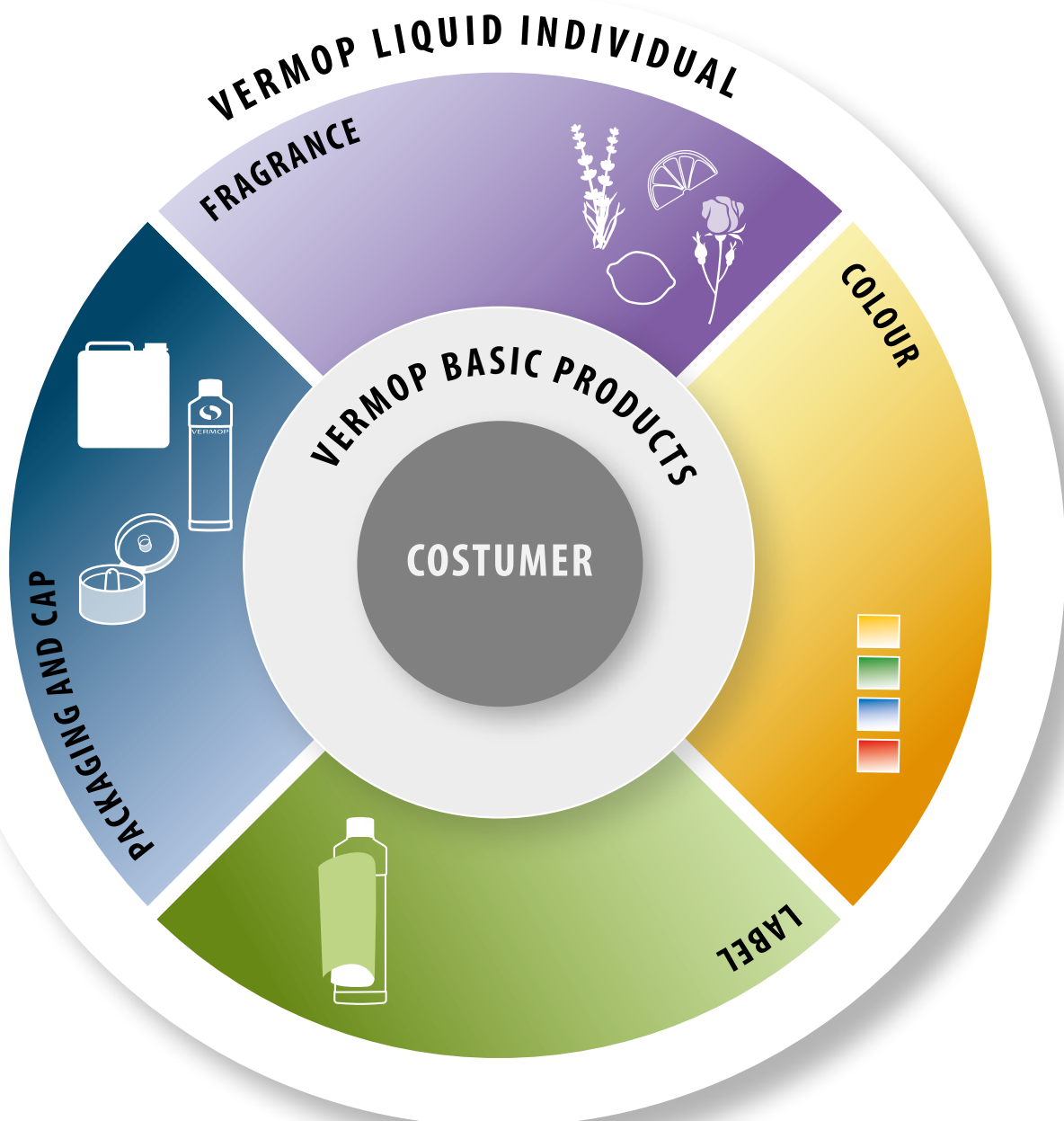

INDEX

	page		page
10 l box	47	brake for wheels 75 mm + 100 mm	89
4 l box, anthracite	46	Brush (Glove mop)	209
Acryl (Damp mop)	185	Brush (Sprint)	174
adapter for section rail, anthracite	44, 61	Brush (Twixter)	164
adapter for steel bars (set)	123	Brush Progressive (Sprint)	176
adapter to change diameter from telescopic (ø 20 mm) to mop handle (ø 23 mm)	223	Brush Progressive (Twix)	168
all purpose floor nozzle (26 cm)	237	Brush Progressive (Twixter)	166
aluminium anodised, 1400 mm, ø 23,5 mm, handle anthracite	195	bucket, 10 l	79
Antibak (Sprint)	175	bucket, 8 l	78
Antibak (Twix)	168	bucket 17 l	49, 64, 79, 99, 113, 122, 135
Antibak (Twixter)	165	bucket 6 l	48, 64, 98, 112, 122, 135
apron made of heavy-weight cotton fabric	228	bucket 8 l	49, 64, 99
Aquva Basic	189	bucket ED	100
Aquva holder, plastic	189	buffer wheel for Equipe Hotel (left)	59
Aquva holder with stainless steel bow	189	buffer wheel for Equipe Hotel (right)	59
Aquva Robbe	189	Cascade 2 wet mop trolley	131
AquvaVIZ (bar structure)	119	Ceran (Damp mop)	185
AquvaVIZ (base frame)	119	Ceran (Glove mop)	209
AquvaVIZ Moboxx	117	Ceran (Scandic Duo)	183
AquvaVIZ Press	117	Ceran (Scandic Mono)	183
AquvaVIZ Twixter Des	118	Ceran (Sprint)	174
AquvaVIZ Wringboy	118	Ceran (Twix)	167
Aquva wet mop trolley, 1 x 17 l	130	Ceran (Twixter)	164
Aquva wet mop trolley, 2 x 17 l	129	Charger	239
Attachment aid	48	chemical centre anthracite	100
attachment for box 35 l, stainless steel	124	Chemical centre Plus	52
attachment for chemical centre incl. fitting for Twixter (Variant)	100	Classic (Sprint)	175
attachment for Moboxx, stainless steel	119	Classic (Sprint Plus)	177
attachment for wire mesh basket for Twixter / F1 wet mop trolley	133	Classic (Twix)	168
attachment incl. 2 hooks, stainless steel	93, 112	Classic (Twixter)	165
bar for base trolley	88	cleanroom 1 (Sprint)	176
bar incl. screws	36	clip for Moboxx	96
bar structure (AquvaVIZ)	119	clip holder for tube	239
base frame (AquvaVIZ)	119	Clipper Basic, tufted	179
base frame (Equipe hotel)	59	Clipper Holder, Plastic	179
base frame (Paper- and waste disposal trolley)	144	Clipper Tronic, tufted	179
base frame (Shopster)	74	Clipper White Magic	179
base frame (Twixter)	132	collapsible frame 1x40 l	40
base frame (Variant)	88	compartment	77
base frame (Varietta)	110	compartment "Light Grey"	62
base frame Garant 2 x 17 l, stainless steel	132	compartment divider for box 5 l, eight-fold	62
base frame L, without wheels, without bars	36	compartment divider for box 5 l, four-fold	62
base frame L for foot pedal, without wheels, without bars	36	compatible broom head	213
base frame M, without wheels, without bars	36	conversion kit for laundry collector	141
base trolley Cascade 2	132	corner profile rail, anthracite	43
Basic (Aquva)	189	corner profile rail, hotel	61
Basic (Clipper)	179	corner profile rail for door, hotel	61
Basic (Damp mop)	185-186	corner profile rail with lock left, anthracite	43
Basic (Sprint)	175	corner profile rail with lock left and hinge right, anthracite	43
Basic (Sprint Plus)	177	corner profile rail with lock right and hinge left, anthracite	43
Basic (Twix)	168	coupler (set of 2 pieces)	37, 60
Basic (Twixter)	165	cover flat, anthracite	44
Basic Light (Sprint)	176	cover flat with equipment holder, anthracite	44
Bastidor plegable 1x70 l	40	cover flat with Twixter equipment holder, anthracite	44
Battery	239	covering panel, 3 sides	76
blade holder 10 cm + 10 blades in a case	227	cover round, short, anthracite	45
Blue (Scandic Mono)	183	cover round with logo, anthracite	44
Blue (Sprint)	174	crevice nozzle	238
Blue (Twix)	167-168	crossbeam, anthracite	42, 60
Blue (Twixter)	165	crossbeam one-sided, anthracite	42
box, pivot joint, 6 l	78	cupboard for consumables, 2 part compartment, hinged, lockable	77
box 12 l, yellow, for hook-up	76	Damp mop Acryl, with band	185
box 15 l, anthracite	47, 63	Damp mop Acryl, with pocket	185
box 20 l, anthracite, for hook-up	76, 134	Damp mop Basic, with band	186
box 35 l, anthracite	47, 63, 121	Damp mop Basic, with pocket	185
box 5 l, anthracite	47, 63	Damp mop Ceran, with pocket	185
box ED	97	Damp mop Holder, zinc-plated	185

	page
disinfection tub 45 l	94
Disposable fleece cloth	186
door stopper 97 cm x ø 12 cm (base)	199
door with handle "Light Grey"	65
door with handle bar, small "Platinum White", left	50
door with handle bar "Platinum White"left	49
door with handle bar "Platinum White"right	49
dosing insert for box 20 l incl. grid and protection against spillage	76
dosing insert for box 35 l incl. grids	121
dosing pump for desinfectant bottle	52
dosing sieve	95
dosing sieve ED	95
double Brush (Twix)	167
double Brush (Twixter)	164
double driving handle with handle holder	46
drawer box, 20 l, for hook-up, at the front	78
driving handle	123
dust bag, Fleece, 3,5 l	240
dust bag (3,5 l)	240
dustpan set complete (anthracite, blue), in display carton, ready to use	197
dustpan set complete (anthracite, blue) to be put together on site	197
dustpan set complete (anthracite, yellow), in display carton, ready to use	197
dustpan set complete (anthracite, yellow) to be put together on site	197
Edge and wall cleaning device	197
element mop cover, Ceran material	212
element mop cover, cotton	211
element mop cover, microfibre	211
element mop cover, White Magic	211
element mop cover, White Magic material	212
element mop holder	211
element mop holder, rubber	211
Element mop plus	40
Equipe (holding frame)	45-46, 61-62
Equipe "wall", multi-optional drawer level, inner side	37
Equipe "wall", multi-optional drawer level, outer side	37
Equipe Advanced I	28
Equipe Advanced II	29
Equipe Advanced III	29
Equipe Advanced IV	30
Equipe Advanced Plus I	32
Equipe Advanced Plus II	33
Equipe Advanced Plus III	33
Equipe Advanced Plus IV	34
Equipe Base I	26
Equipe Base II	27
Equipe Base III	27
Equipe Base IV	28
Equipe Base Plus I	30
Equipe Base Plus II	31
Equipe Base Plus III	31
Equipe Base Plus IV	32
Equipe H1 Light Grey	56
Equipe H2	56
Equipe H3	57
Equipe Hotel, large	58
Equipe hotel (base frame)	59
Equipe Laundry trolley, 2 x 120 l	58
Equipe Minibar, small	57
equipment holder	93, 120
equipment holder, in front, 20 - 28 mm	79
equipment holder, in front, 20 - 28 mm, Module Des	79
equipment holder, lateral, 20 - 28 mm	80, 107
equipment holder, plastic, anthracite	93
equipment holder, plastic, blue	93
Equipment holder bar with 6 hooks incl. 3 equipment holder rubbers	41
equipment holder for tray XL, anthracite	93

	page
equipment holder for tray XL, blue	93
equipment holder Twixter	93
equipment holder ø 22 - 30 mm	45
extension (Equipe)	37, 60
Extension unit (Equipe)	38-39
extra wide switch-over nozzle (30 cm)	238
F1 flat wringer ED	98
F1 flat wringer press	97, 133
fixation for waste sacs, yellow	100, 107, 113, 123
four-fold equipment holder	145
frame for wringer press VK 4 AquvaVIZ, stainless steel	124
Furniture nozzle (25 cm)	238
Garant wet mop trolley, 2 x 17 l, stainless steel	128
Glassman safety scraper	227
Glove mop Brush	209
Glove mop Ceran	209
Glove mop White Magic / Blue	209
grid (AquvaVIZ)	119
grid (Variant)	92
grid (Varietta)	111
grid for boxes 15 l / 35 l (set)	48, 63, 96, 120
grid II (Variant)	91-92
grid set for buckets 17 l	99, 113, 122
grid set for buckets 6 l	99, 112, 122
handle	221
handle, stainless steel	193, 195
handle for element mop	211
handle holder 2HN	79
Hand pad brush	210
hanging warning sign	199
hard surface nozzle	238
HEPA-filter	239
Holder (Aquva)	189
Holder (Clipper)	179
Holder (Damp mop)	185
Holder (Scandic Duo)	182
Holder (Scandic Mono)	182
Holder (Sprint)	173
Holder (Sprint Plus)	173, 177
Holder (Sprint V)	173
Holder (Twix)	167
Holder (Twixter)	164
holder 10 l box	51
holder attaches to stabilizer for bucket 8 l	51
holder Des	52
holder for chemical centre (Variant)	100
holder for vacuum cleaner (set), extension M	51
holder for vacuum cleaner for base frame L (set)	51
holding clips (set of 4)	40
holding frame (Equipe)	45-46, 61-62
holding frame (Shopster)	74-75
holding frame (Variant)	89-91
holding frame (Varietta)	110-111
holding frame 120 l, chrome coated	110, 145
holding frame 1 x 120 l	144
holding frame 1 x 20 l for hook-up on holding frame 2 x 35 l	75
holding frame 1 x 40 l	90, 111, 119
holding frame 2 x 20 l	90, 110, 119
holding frame 2 x 70 l	144
holding frame 70 l, chrome coated	110, 145
holding frame for bucket 8 l	79
holding frame for mop	80, 107
holding frame for shelves, stainless steel	62
holding frame on crossbeam for bucket 8 l (raised)	51
holding frame on crossbeam for bucket 8 l (standard)	51
holding frame with equipment holder on crossbeam for 8 l bucket	51
hose for Jetvac	240
hose for Jetvac accu	240
inlying rail, anthracite	43

INDEX

	page		page
inlying rail with lock and corner profile rail for door hinge I+r, anthracite	44	profi-chamois leather 80 x 60 cm	228
insert for box, pivot joint	78	profi-cone with safety button "Pinocchio"	223
insert grid, anthracite (Shopster), plastic	77	profile rail for compartment	61
joint, anthracite	223	Progressive (Sprint)	175-176
jointings cleaning brush	198	Progressive (Twix)	168
jute sac (4 eyelets) 190 l	145	Progressive (Twixter)	166
laundry net	53, 66, 75, 101, 107, 113, 123	Progressive cloth	208
laundry net holder 60	46	protection against spillage	76
laundry net holder 70	46	protection against spillage for dosing insert	95
laundry sac, white, coloured stripes	141	push bar incl. attachment for 2 x 6 l buckets, for base frame Twixter II	133
lid	48	push-in box, 20 l, anthracite, to fit at rear	78
lid / Bucket 6 l	98, 122, 135	quiver	228
lid 120 l, blue	145	radiator cleaner, incl. cover "Brush"(set consists of 1 tool plus 5 covers)	213
lid ED	97, 100	rear panel "Platinum White"	50
lid for bucket, 8 l	78	Rear panel H "Light Grey"	66
lid for bucket 6 l	49, 64	Rear panel H "Platinum White"	50
lid for bucket 8 l	49, 64	rear panel H + 10 l box "Platinum white"	50
lid for holding frame 120 l	65, 99, 114	rear panel H + Toolbox	51
lid for holding frame 70 l	99, 114, 122	Red (Twixter)	165
lid for laundry collector	141	Replacement rail	221
lid for Moboxx with seal	96, 121	Robbe (Aqua)	189
lid without sealing for boxes 5 / 15 / 35 l, fully-coloured without imprint	48, 63	round brush nozzle	238
lid with sealing for boxes 5 / 15 / 35 l, transparent with coloured imprint	48, 64	safety scraper with blade	227
LockStrip D	222	Scandic Cleaning Speed Runner	182
LockStrip K	222	Scandic Duo Ceran	183
LockStrip pad K	222	Scandic Duo Holder	182
LockStrip Ultra pad K	222	Scandic Mono Blue	183
main filter	239	Scandic Mono Ceran	183
Measuring cup	199	Scandic Mono Holder	182
Meditrans laundry collector double	138, 140	Scandic Mono Tronic	182
Meditrans laundry collector single	137, 140	Scandic Mono White Magic	183
Meditrans laundry collector triple	139-140	Scandic Mono White Magic OA	183
Meditrans laundry system, single	137, 140	Scandic telescopic handle, with fixed ball (Sprint / Sprint Plus / Scandic Mono) ø 23,5 mm	195
Mini Aqua handle with thread	189	Scandic telescopic handle, with rotating ball (Twixter / Twix / Sprint V / Scandic Duo) ø 23,5 mm	195
Mini Aqua set without handle	189	Scandic X Toolbox "Platinum White"	36
Mistral wet mop trolley, 1 x 17 l, chrome coated	131	scraper short (for telescopic stick)	227
Mistral wet mop trolley, 2 x 17 l, chrome coated	129	Set element mop with handle, cotton	210
Moboxx, anthracite with coloured clips	96, 120	Set element mop with handle, microfibre	210
Moboxx sealing ring	96	Set element mop with rubber holder, microfibre	210
module Des	41	Set element mop with rubber holder, White Magic	210
module F1	41	shelf "Light Grey", narrow	62
module Moboxx	41	shock protection for Equipe (set of 4)	60
module Sprint	41	shock-protection plus	36
module Sprint lateral	42	shock protection plus set Equipe (4 pcs)	36
module Twixter-Press	41	shock protection Shopster (set of 4)	74
multi-function lid, lockable	65	Shopster (base frame)	74
multi-purpose-fleece cloth	208	Shopster (holding frame)	74-75
Multi-purpose gripper	198	Shopster Des	72
pad	197	Shopster Jetvac	72
pad Brush	197	Shopster Pre-Wash I	71
pad disc Blue E	196	Shopster Pre-Wash II	71
pad disc Brush E	196	Shopster Sprint	70
pad disc White Magic E	196	Shopster Stairs Sprint	73
panning-lid	49, 65	Shopster Twix-Press	70
Paper- and waste disposal trolley (base frame)	144	side panel "Light Grey"	66
paper picker with handle	198	side panel "Platinum White"	50
paper trolley X-Form	142, 144	side panel "Platinum White"for Multiwall	50
pictogram set with 6 images	200	Sign, aluminium	194
piggy-back 1x120 l	101	Softtronic	208
pipe cleaning brush, adaptable to telescopic handle	213	Softy cloth	208
plastic covering for Scandic holder	182	spare rubber ring	141
pocket bag for AquaVIZ, anthracite	123	Sprint Antibak	175
pocket bag for paper trolley	145	Sprint Basic	175
polypropylene sac (4 eyelets) 190 l	146	Sprint Basic Light	176
polypropylene sac 120 l, with cord	146	Sprint Blue	174
preparation box	47	Sprint Brush	174
Pressure pump sprayer	199	Sprint Brush Progressive	176
Profi-bucket yellow 22 l	227	Sprint Ceran	174

	page
Sprint Ceran OA	174
Sprint Classic	175
Sprint cleanroom 1	176
Sprint Holder, stainless steel	173
Sprint Plus Basic	177
Sprint Plus Classic	177
Sprint Plus Holder	173, 177
Sprint Plus Tronic	177
Sprint Progressive	175-176
Sprint Tronic	173
Sprint Tronic Light	175
Sprint Ultra	175
Sprint V Holder	173
Sprint White Magic	174
Sprint White Magic cleanroom	176
Sprint White Magic OA	174
Squeegee	221
Squeegee Rubber	221
Squeegee Rubber hard	222
stabiliser (left) with 6 hooks and 3 equipment holders, anthracite	43
stabiliser (right) with 6 hooks and 3 equipment holders, anthracite	43
Stabiliser short plus HR 2x40 l	40
stabiliser with 6 hooks and 3 equipment holders, anthracite	42
stabilizer (left) with 3 hooks, incl. 2 stick holders and 2 tube holders	61
stabilizer (right) with 3 hooks, incl. 2 stick holders and 2 tube holders	61
stabilizer flat, anthracite	42
stabilizer flat (left), anthracite	42, 60
stabilizer flat (right), anthracite	42, 60
Starter Set TopLock 35 cm	229
Starter Set TopLock 45 cm	229
stick attachment, stainless steel	93, 111, 120
strainer for Profi-bucket	228
supporting grid for mop holder, lateral	94
supporting grid for mop holder for paper trolley	145
Swing door left "Platinum White"	40
Swing door right "Platinum White"	40
swivel connector for Mistral / Garant	132
swivel connector for wet mop trolley plastic	132
swivel connector for wet mop trolley plastic 1 x 17 l	132
T-Bar	222
telescopic handle, ø 23,5 mm, handle anthracite	195
Telescopic handle D	225
Telescopic handle Z	225
Telescopic handle ZR	225
telescopic tube in stainless steel, incl. clip	239
Textronic microfibre cloth	208
Textronic Pad	194
toilet cleaning set (anthracite / red)	213
toilet cleaning set (anthracite / yellow)	213
toilet paper holder	52, 101
tray L	97, 120
tray M	96, 112, 120
tray XL	97
Trigger bottle	214
Tronic (Clipper)	179
Tronic (Scandic Mono)	182
Tronic (Sprint)	173
Tronic (Sprint Plus)	177
Tronic (Twix)	167
Tronic (Twixter)	164
Tronic Light (Sprint)	175
Tronic Light (Twixter)	165
tub 20 l	95, 134
turbo nozzle 28 cm	238
Twix Antibak	168
Twix Basic	168
Twix Blue	167-168

	page
Twix Brush Progressive	168
Twix Ceran	167
Twix Classic	168
Twix double Brush	167
Twix Holder	167
Twix Progressive	168
Twixter (base frame)	132
Twixter Antibak	165
Twixter Basic	165
Twixter Blue	165
Twixter Brush	164
Twixter Brush Progressive	166
Twixter Ceran	164
Twixter Classic	165
Twixter dosing insert	95
Twixter dosing insert MS	94
Twixter double Brush	164
Twixter Holder	164
Twixter Progressive	166
Twixter Red	165
Twixter Tronic	164
Twixter Tronic Light	165
Twixter White Magic	164
Twixter wringer	97, 133
Twix Tronic	167
Twix White Magic	167
Twix wringer 30 cm	76
Ultra (Sprint)	175
unit for wringer VK 4 Shopster	77
Variant (base frame)	88
Variant (holding frame)	89-91
Variant 20 (chrome coated)	85
Variant 23 (chrome coated)	85
Variant 26 Ergo (chrome coated)	84
Variant 27 (chrome coated)	84
Variant 27 (stainless steel)	87
Variant AS (chrome coated)	86
Variant Des 2000 / K (chrome coated)	83
Variant Twixter-Press (chrome coated)	83
Variant Twixter-Press (stainless steel)	86
Varietta (base frame)	110
Varietta (chrome coated)	109
Varietta (holding frame)	110-111
Varietta Plus 2 (chrome coated)	109
velcro strips for Scandic holder 28 cm	182
velcro strips for Scandic holder 40 cm	182
velcro strips for Scandic holder 60 cm and 120 cm	182
vertical wringer VK 4	77, 98, 112, 121, 134
V-mop, slot in, extra long, with handgrip	212
V-mop, slot in, with handgrip	212
V-mop, with handle	212
wall and ceiling brush head, length adjustable 830 - 1490 mm, round shaped head	213
wall and ceiling brush head, length adjustable 850 - 1500 mm, oval shaped head	212
wall cleaning brush, adaptable to telescopic handle	213
wall holder collapsible	141
waste and transport trolley	143-144
Waste sac	53, 66, 75, 100, 107, 113, 123
waste sac coating for detachable extension	65
waste sac coating for extension M	65
Water filling device	198
wet floor sign	199
wet mop trolley F1, stainless steel	128
wet mop trolley Twixter, stainless steel	127
wet mop trolley Twixter 2, stainless steel	127
wetting box, anthracite	47, 63
Wheel	35, 59
wheel, 100 mm, without lockable brake	88
wheel, 125 mm, with lockable brake	89
wheel, 125 mm, without lockable brake	88

INDEX

	page
wheel, 150 mm, without lockable brake	88
Wheel FB	35, 59
wheels for Profi-bucket, 4 pcs.	228
wheel with lockable brake, 150 mm	89
White Magic / Blue (Glove mop)	209
White Magic (Clipper)	179
White Magic (Scandic Mono)	183
White Magic (Sprint)	174
White Magic (Twix)	167
White Magic (Twixter)	164
White Magic cleanroom (Sprint)	176
wire basket III	101
wire basket IX	133
wire mesh basket VI, for wet mop trolley 1 x 17 l and 1 x 25 l	133
work schedule holder	52, 75, 101
work schedule holder Plus	52
Wringboy	121, 198
wringer holder, rigid, Varietta	113
wringer insert for F1	98, 134
wringer insert for VK 4	77, 98, 112, 121, 134



VERMOP Salmon GmbH
Zweigniederlassung Wertheim

Hafenstraße 16
97877 Wertheim
GERMANY
Tel. +49 9342 878 - 0
Fax +49 9342 878 - 173
info@vermop.com
www.vermop.com

05-18-2 code: 994118EN

English

We reserve the right to make technical changes and changes in content. No liability shall be assumed for errors or omissions.

